



facebook



facebook



facebook

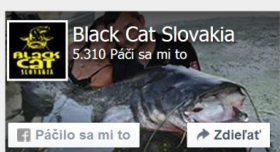

facebook



facebook



facebook

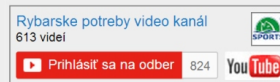

YouTube

# ZEBCO EUROPE



## CATALOGUE 2018

kompletný cenník  
nájdete na  
[www.SPORTS.sk](http://www.SPORTS.sk)

Klikni &gt;&gt;&gt;

RYBÁRSKA TELEVÍZIA



&lt;&lt;&lt;Klikni

QUANTUM®

RADICAL

BROWNING  
FISHINGBLACK  
CAT

RHINO

ZEBCO®

FIN-NOR®

VAN STAAL®

MT  
Magic Trout



# Contents

## QUANTUM Rods & Reels

Q3-Q57

### Accessories

Q58-Q124



QUANTUM®

## MAGIC TROUT

MT1-MT28



MT  
Magic Trout®

## BLACK CAT Rods & Reels

BC3-BC29

### Accessories

BC30-BC74



BLACK  
CAT

## BROWNING Rods & Reels

B4-B79

### Accessories

B80-B174



BROWNING®  
FISHING

## RADICAL Rods & Reels

RA3-RA9

### Accessories

RA10-RA64



RADICAL

## FIN-NOR

FN1-FN24



FIN-NOR®  
LEGENDARY TACKLE SINCE 1933

## RHINO

R1-R34



RHINO

## VAN STAAL

VS1-VS2



VAN STAAL®

## ZEBCO Reels

Z3-Z17

### Rods

Z18-Z43

### Accessories

Z44-Z178



ZEBCO®  
Let's go fishing.



# QUANTUM®

**One giant leap in specialist fishing tackle!**

**Those who dedicate themselves completely to one discipline of angling have no time for average, allround equipment.**

**Quantum offers exactly the top quality tackle required.**



kompletný cenník na [www.SPORTS.sk](http://www.SPORTS.sk), výhradný distribútor pre SR: SPORTS s.r.o.





<b>REELS</b>	<b>Q 3</b>
Exo Ti	Q 3
Smoke Spinning	Q 4
Smoke Speed Freak	Q 5
Smoke Inshore Speed Freak	Q 6
Cabo PT	Q 7
Energy PT	Q 8
Accurist PT	Q 9
Iron PT	Q 10
Axius FD	Q 11
Ultrax FD	Q 12
Fire FD	Q 13
Trax II	Q 14
Hypercast TP	Q 15
Centex	Q 16
Vantex	Q 17
Drive	Q 18
Throttle	Q 19
Mr. Pike The Releaser	Q 20
Thrill BT	Q 21
Centex Micro FD	Q 22
World Champion Surf SLO	Q 23
Maniac Duracast Surf	Q 24
Smart Motion Surf	Q 25
Maniac FD	Q 26
Exo Baitcaster	Q 27
Tour Mg PT Baitcaster	Q 28
Smoke S3 LH 101 HPT	Q 29
Smoke Inshore	Q 30
Accurist	Q 31
Icon	Q 32
Ultrax Cast	Q 33

<b>RODS</b>	<b>Q 34</b>
Smoke Spin	Q 34
Smoke Spin Traveller	Q 34
Smoke Vertical	Q 34
Smoke Vertical Inline	Q 34
Pelagic	Q 36
Cabo Spin	Q 36
Iron Spin	Q 38
Iron Jig	Q 38
Iron Heavy Jig	Q 38
Blu Spin	Q 38
Throttle Spin	Q 40
Hypercast Power Jig	Q 40
Zanderkant	Q 40
Scalpel Spin	Q 42
Fire Spin	Q 42
Hypercast XTC II	Q 42
Ultrax Cast	Q 44
Ultrax Spin	Q 44
Ultrax Jerk TR	Q 44
Ultrax Vertical	Q 44
Ultrax Big Bait	Q 46
Ultrax Dead Bait	Q 46
Ultrax Drop Shot	Q 46
Centex Felchen	Q 48
Hypercast Freezer	Q 48
Mr. Pike Standard Boat	Q 50
Mr. Pike Old School Zander	Q 50
Mr. Pike Classic Bank	Q 50
Mr. Pike Tele Bank	Q 50
W. Champ. Surf Masterp.	Q 52
Maniac Duracast Surf	Q 52

Iron Surf	Q 54
Torrent Beach Fighter	Q 54
Torrent Buscle 80	Q 56
Iron Dorada 110	Q 56
Torrent Beach Fighter Tele	Q 56
Iron Tele Surf	Q 56

<b>ACCESSORIES</b>	<b>Q 58</b>
Lines Exofil	Q 58
Lines Quattron	Q 60
Lines Ultrax	Q 62
Lines Smart XTR Braid	Q 64
Quattron Mono Leader	Q 65
Plugs	Q 66
Lure Sets	Q 75
Shads	Q 76
Hooks to Nylon	Q 90
Hooks to Nylon & Swivel	Q 94
Wire traces	Q 96
Spinner	Q 105
Wire traces & Accessories	Q 106
Jig Heads, Lamps, Accessories	Q 108
Buckets / Carryall	Q 112
Tents, Accessories	Q 114
Landing nets	Q 116
Clothing	Q 118
Carryall	Q 121
Boxes, Rod Stands & Measuring Mats	Q 122
Promotional items	Q 124

<b>MR. PIKE</b>	
<b>REELS</b>	
The Releaser	Q 20

<b>RODS</b>	
Mr. Pike Standard Boat	Q 50
Mr. Pike Old School Zander	Q 50
Mr. Pike Classic Bank	Q 50
Mr. Pike Tele Bank	Q 50

<b>ACCESSORIES</b>	
Floats	Q 98
Wire traces	Q 100
Holdall, Clothing, Landing nets, Accessories	Q 102
Carryall & Accessories	Q 104



**STANDARD TECHNICAL EQUIPMENT:**

- Rotor in C4LF™ Carbon
- Aluminium skeleton housing
- Finely adjustable CSC™ front drag system (carbon drag discs)
- CNC stainless steel handle
- Titanium-nitride-coated line roller with anti-twist system
- Ni-Ti™ indestructible bail system
- Titanium reel shaft
- Perforated aluminium Long Stroke™ spool with ceramic front edge
- Perfect line distribution
- Continuous anti-reverse
- MegaShield™ multi-layer coating

**EXO TI**

Dream high-end spinning reel with breathtakingly light weight. The skeleton design delivers unparalleled rigidity combined with outstanding functionality. Available in the four most popular sizes. From the cute size 20 for trout anglers through to the fully-grown pike and salmon model in size 50. The new edition has been further optimised and impresses with its silky smooth action and indestructible titanium axle.



Code	Model	m / mm	Gear Ratio	Retrieve	BB	Drag F.	Weight	Spare Spool	Model	Material
0513 020	1120	140 / 0,20	5,3:1	73 cm	11	7,3 kg / 16 lbs	230 g	0987 404	Sp. Spool Exo Ti 1120	Alu
0513 030	1130	150 / 0,30	5,2:1	80 cm	11	9,1 kg / 20 lbs	255 g	0987 405	Sp. Spool Exo Ti 1130	Alu
0513 040	1140	210 / 0,23	5,2:1	85 cm	11	9,1 kg / 20 lbs	280 g	0987 406	Sp. Spool Exo Ti 1140	Alu
0513 050	1150	205 / 0,24	5,2:1	93 cm	11	10,0 kg / 22 lbs	305 g	0987 407	Sp. Spool Exo Ti 1150	Alu





STANDARD TECHNICAL EQUIPMENT:

- Rotor in C4LF™ Carbon
- Aluminium skeleton housing
- Finely adjustable CSC™ front drag system (carbon drag discs)
- Ultra-light handle in hardened aluminium and skeleton design with EVA handles
- Titanium nitride line roller
- Ni-Ti™ indestructible bail system
- PT™ gears
- Aluminium spool with hardened front edge for longer casting distances
- Two-speed oscillation system
- Continuous anti-reverse
- Foot Forward™ reel foot for better rod balance

SMOKE SPINNING

The new Smoke is the second generation of the universally popular, high-end spinning reel in skeleton design. An additional ball-bearing has been added to give the new Smoke Spin an even smoother gear action. Now with 10 ball-bearings and a roller bearing, the reel is not significantly different in weight from the first series. The light weight, subtle design changes and an even smoother gear action make the reel the best Smoke of all time.



Code	Model	m / mm	Gear Ratio	Retrieve	BB	Drag F.	Weight	Spare Spool	Model	Material
0517 015	SL15SPTIA	140 / 0,18	5,3:1	66 cm	11	6,4 kg / 14 lbs	179 g	0987 048	Sp.Spool Smoke Spinning SL15SPTIA	Alu
0517 025	SL25SPTIA	140 / 0,20	5,2:1	71 cm	11	7,3 kg / 16 lbs	216 g	0987 049	Sp.Spool Smoke Spinning SL25SPTIA	Alu
0517 030	SL30SPTIA	140 / 0,22	5,2:1	76 cm	11	8,2 kg / 18 lbs	223 g	0987 050	Sp.Spool Smoke Spinning SL30SPTIA	Alu
0517 040	SL40SPTIA	210 / 0,22	5,2:1	86 cm	11	8,2 kg / 18 lbs	275 g	0987 054	Sp.Spool Smoke Spinning SL40SPTIA	Alu
0517 050	SL50SPTIA	205 / 0,24	5,2:1	91 cm	11	9,1 kg / 20 lbs	284 g	0987 055	Sp.Spool Smoke Spinning SL50SPTIA	Alu



STANDARD TECHNICAL EQUIPMENT:

- Rotor in C4LF™ Carbon
- Aluminium skeleton housing
- Finely adjustable CSC™ front drag system (carbon drag discs)
- Ultra-light handle in hardened aluminium and skeleton design with EVA handles
- Titanium nitride line roller
- Ni-Ti™ indestructible bail system
- PT™ gears
- Aluminium spool with hardened front edge for longer casting distances
- Two-speed oscillation system
- Continuous anti-reverse
- Foot Forward™ reel foot for better rod balance

SMOKE SPEED FREAK

The Smoke Speed Freak is, as the name suggests, a reel with an extremely high gear ratio of 6.2:1. The size-25 model takes up 87 cm of line with just one turn of the handle without feeling in any way sluggish. Particularly in modern zander fishing, it is essential to hook the fish securely and to present baits significantly more easily and yet effectively.



Code	Model	m / mm	Gear Ratio	Retrieve	BB	Drag F.	Weight	Spare Spool	Model	Material
0518 025	SL25SFPTIA	150 / 0,24	6,2:1	87 cm	10	7,3 kg / 16 lbs	220 g	0987 031	Sp.Spool Speed Freak SL25SFPTIA	Alu
0518 030	SL30SFPTIA	195 / 0,24	6,2:1	95 cm	10	8,2 kg / 18 lbs	228 g	0987 032	Sp.Spool Speed Freak SL30SFPTIA	Alu





**SMOKE INSHORE SPEED FREAK**

Perfect mid-sized spinning reels for sea anglers – whether for bass, cod or sea trout. The special production methods and materials ensure extreme corrosion resistance even with frequent use in the marine environment. And the angler has a chance to appreciate the renowned combination of lightness and stability offered by Smoke reels.



**STANDARD TECHNICAL EQUIPMENT:**

- Rotor in C4LF™ Carbon
- Robust light metal body in skeleton design
- Finely adjustable CSC™ front drag system (carbon drag discs)
- CNC stainless steel handle
- Anti-twist line roller
- Exclusive TiMag™ system: Maintenance-free magnetic bail arm folding system
- Gears made from a super-hard stainless steel alloy
- Aluminium spool with hardened front edge for longer casting distances
- Rapid line retrieval
- with permanent anti-reverse

Code	Model	m / mm	Gear Ratio	Retrieve	BB	Drag F.	Weight
0299 040	SL40XPTS	210 / 0,22	6,2:1	99 cm	10	9,0 kg / 20 lbs	227 g

Spare Spool	Model
0987 358	Sp. Spool Smoke Inshore Spinning Speed Freak SL40XPTS

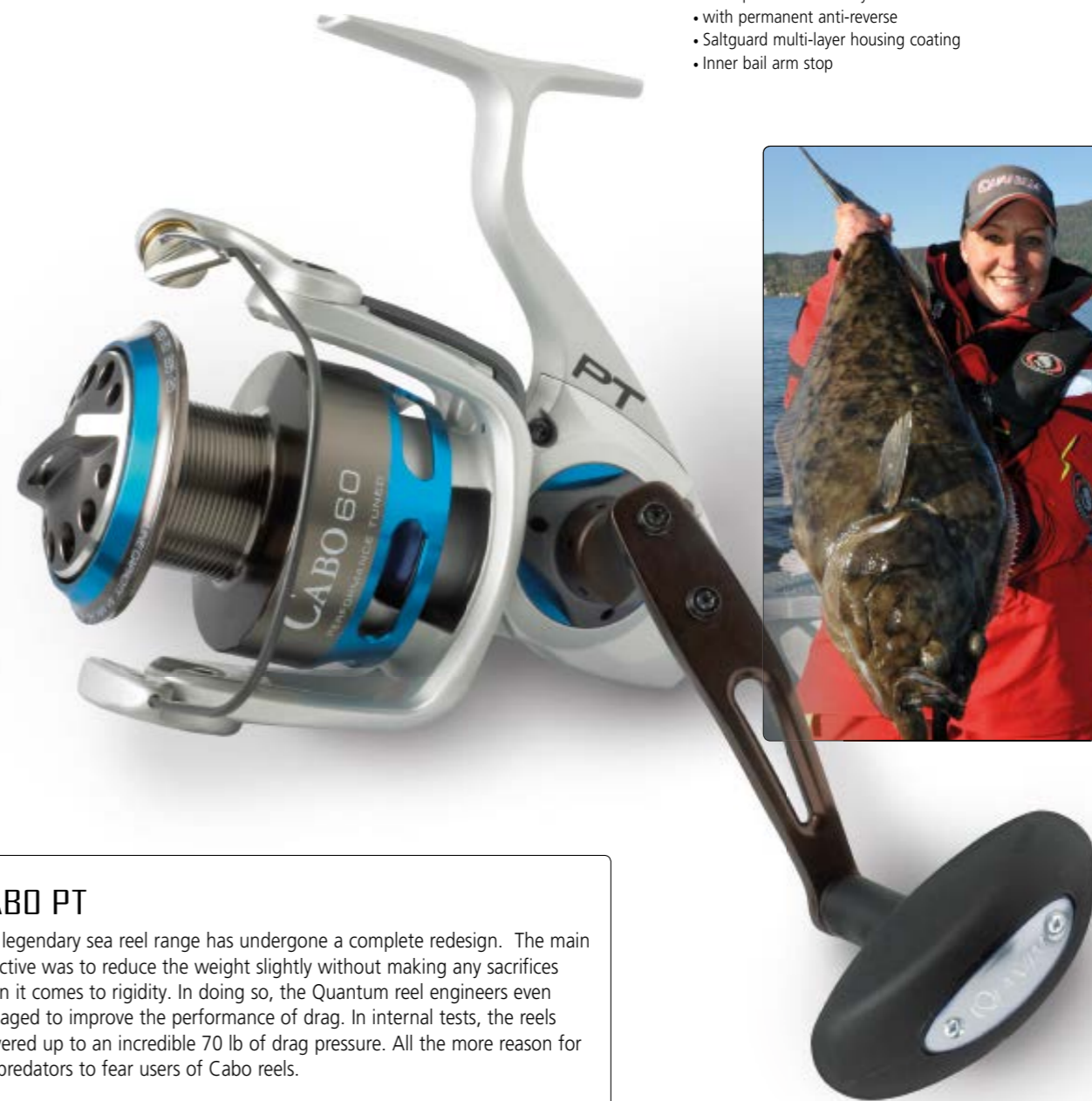

**CABO PT**

This legendary sea reel range has undergone a complete redesign. The main objective was to reduce the weight slightly without making any sacrifices when it comes to rigidity. In doing so, the Quantum reel engineers even managed to improve the performance of drag. In internal tests, the reels delivered up to an incredible 70 lb of drag pressure. All the more reason for sea predators to fear users of Cabo reels.



Code	Model	m / mm	Gear Ratio	Retrieve	BB	Drag F.	Weight
0268 040	CSP40PTsE	210 / 0,23	5.3:1	84 cm	8	13,6 kg / 30 lbs	394 g
0268 050	CSP50PTsE	200 / 0,24	5.3:1	91 cm	8	15,9 kg / 35 lbs	400 g
0268 060	CSP60PTsE	275 / 0,25	4.9:1	94 cm	8	20,4 kg / 45 lbs	680 g
0268 080	CSP80PTsE	300 / 0,30	4.9:1	104 cm	8	24,9 kg / 55 lbs	710 g
0268 100	CSP100PTsE	430 / 0,30	4,7:1	96 cm	8	27,2 kg / 60 lbs	924 g
0268 120	CSP120PTsE	530 / 0,30	4,7:1	127 cm	8	29,5 kg / 65 lbs	935 g

Spare Spool	Model	Material
0987 267	Sp.Spool Cabo CSP40PTsE	Alu
0987 268	Sp.Spool Cabo CSP50PTsE	Alu
0987 269	Sp.Spool Cabo CSP60PTsE	Alu
0987 270	Sp.Spool Cabo CSP80PTsE	Alu
0987 003	Sp.Spool Cabo CSP100PTsE	Alu
0987 004	Sp.Spool Cabo CSP120PTsE	Alu

- STANDARD TECHNICAL EQUIPMENT:**
- Rotor produced in aluminium to be completely distortion-free
  - Robust light metal body in skeleton design
  - Finely adjustable, protected Magnum CSC™ front drag system (carbon drag discs)
  - CNC stainless steel handle
  - Non-twist line roller supported by ball bearings
  - Exclusive TiMag™ system: Maintenance-free magnetic bail arm folding system
  - Gears made from a super-hard stainless steel alloy
  - Aluminium spool with hardened front edge for longer casting distances
  - Two-speed oscillation system with LMS™ line distribution
  - with permanent anti-reverse
  - Saltgard multi-layer housing coating
  - Inner bail arm stop





STANDARD TECHNICAL EQUIPMENT:

- Robust light metal body in skeleton design
- Finely adjustable CSC™ front drag system (carbon drag discs)
- 100% wobble-free aluminium handle, just screws out without folding over
- Titanium-nitride-coated line roller with anti-twist system
- Ni-Ti™ indestructible bail system
- Spare spool with special Anti-Slip-Core for braids
- Foot Forward™ reel foot for better rod balance

ENERGY PT

The latest Energy is without doubt the best Energy of all time! Extremely lightweight and with ultra-smooth gears – sheer poetry! The reel has also benefited from the evolution in reel design that resulted from development of the Exo and the Smoke. The proven technology on the inside has now been packed into a considerably lighter housing. And when it comes to the Energy, 'light' also means 'robust' – as emphatically proven in internal testing! This elegant reel is sure to offer many anglers the ideal compromise between performance, robustness and affordability.



Code	Model	m / mm	Gear Ratio	Retrieve	BB	Drag F.	Weight	Spare Spool	Model	Material
0505 015	E15PTID	115 / 0,26	5,3:1	63 cm	11	3,6 kg / 8 lbs	199 g	0987 315	Sp. Spool Energy E15PTID	Alu
0505 025	E25PTID	140 / 0,26	5,2:1	66 cm	11	8,6 kg / 19 lbs	232 g	0987 316	Sp. Spool Energy E25PTID	Alu
0505 030	E30PTID	165 / 0,26	5,2:1	73 cm	11	8,6 kg / 19 lbs	241 g	0987 317	Sp. Spool Energy E30PTID	Alu
0505 040	E40PTID	250 / 0,28	5,2:1	78 cm	11	8,6 kg / 19 lbs	316 g	0987 318	Sp. Spool Energy E40PTID	Alu



STANDARD TECHNICAL EQUIPMENT:

- Robust light metal body in skeleton design
- Finely adjustable CSC™ front drag system (carbon drag discs)
- Titanium-nitride-coated line roller with anti-twist system
- Ni-Ti™ indestructible bail system
- Aluminium Long Stroke™ spool
- Foot Forward™ reel foot for better rod balance

ACCURIST PT

The Accurist has strong genetic links with the Energy. The ultra-soft gear action is sure to impress many an angler. In the size 25 and size 30 Accurist, we offer even demanding and spoilt spinning anglers the two most popular sizes. The black and white design was particularly well received in pre-production tests and is in line with modern trends. However, design is not everything, which is why the reel is also based upon innovative Quantum skeleton housing technology.



Code	Model	m / mm	Gear Ratio	Retrieve	BB	Drag F.	Weight	Spare Spool	Model	Material
0506 015	AC15PTIA	115 / 0,26	5,3:1	63 cm	8	3,6 kg / 8 lbs	213 g	0987 320	Sp. Spool Accurist AC15PTIA	Alu
0506 025	AC25PTIA	140 / 0,26	5,2:1	66 cm	8	8,6 kg / 19 lbs	244 g	0987 321	Sp. Spool Accurist AC25PTIA	Alu
0506 030	AC30PTIA	165 / 0,26	5,2:1	73 cm	8	8,6 kg / 19 lbs	253 g	0987 322	Sp. Spool Accurist AC30PTIA	Alu
0506 040	AC40PTIA	250 / 0,28	5,2:1	78 cm	8	8,6 kg / 19 lbs	316 g	0987 323	Sp. Spool Accurist AC40PTIA	Alu





STANDARD TECHNICAL EQUIPMENT:

- Electronically balanced lightweight rotor (LWR)
- Robust light metal body in skeleton design
- Finely adjustable, protected CSC™ front drag system (carbon drag discs)
- Stainless steel handle with EVA handle knob
- Titanium-nitride-coated line roller
- Specially hardened Quantum PT gears
- Aluminium spool with hardened front edge for longer casting distances
- Two-speed oscillation system with LMS™ line distribution
- Continuous anti-reverse
- Saltguard multi-layer housing coating

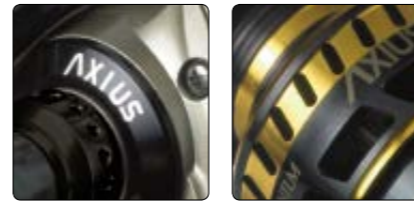

STANDARD TECHNICAL EQUIPMENT:

- Balanced rotor, producing silky smooth action
- Robust nylon housing
- Finely adjustable front drag
- Slimline handle
- Anti-twist line roller
- Thick bail arm for optimal balance
- Smooth gears with even line distribution
- Aluminium Long Stroke™ spool
- Aluminium spare spool
- S-curve line distribution
- Foot Forward™ reel foot for better rod balance



IRON PT

A supreme spinning reel tailor-made for using on the sea with salt-water-resistant components throughout. Highly robust design that can withstand use with braided lines for months on end. In a fight, the Inshore's front drag, with Magnum carbon drag discs, means the angler always has control. The spool has a special anti-slip core meaning braid can be directly wound onto the spool.



Code	Model	m / mm	Gear Ratio	Retrieve	BB	Drag F.	Weight
0305 025	IR25PTS	180 / 0,20	5,2:1	72 cm	6	7,3 kg / 16 lbs	253 g
0305 030	IR30PTS	180 / 0,22	5,2:1	72 cm	6	8,2 kg / 18 lbs	260 g
0305 040	IR40PTS	230 / 0,22	5,2:1	84 cm	6	9,1 kg / 20 lbs	329 g
0305 050	IR50PTS	225 / 0,24	5,2:1	92 cm	6	11,3 kg / 25 lbs	337 g

Spare Spool	Model	Material
0987 010	Sp.Spool Iron IR25PTS	Alu
0987 011	Sp.Spool Iron IR30PTS	Alu
0987 012	Sp.Spool Iron IR40PTS	Alu
0987 013	Sp.Spool Iron IR50PTS	Alu

AXIUS FD

Impressive mid-priced fixed-spool reel with minimal production tolerances, ensuring a soft gear action and long service life. Spinning and legering anglers will quickly come to appreciate this reel in hard everyday use. And predators will come to fear the drag strength of this reel series!



Code	Model	m / mm	Gear Ratio	Retrieve	BB	Drag F.	Weight
0314 020	1020	200 / 0,20	5,2:1	69 cm	10	4,5 kg / 10 lbs	278 g
0314 030	1030	210 / 0,25	5,2:1	72 cm	10	4,5 kg / 10 lbs	283 g
0314 040	1040	190 / 0,35	4,8:1	75 cm	10	5,4 kg / 12 lbs	408 g

Spare Spool	Model
0987 075	Sp. Spool Axius FD 1020
0987 076	Sp. Spool Axius FD 1030
0987 077	Sp. Spool Axius FD 1040



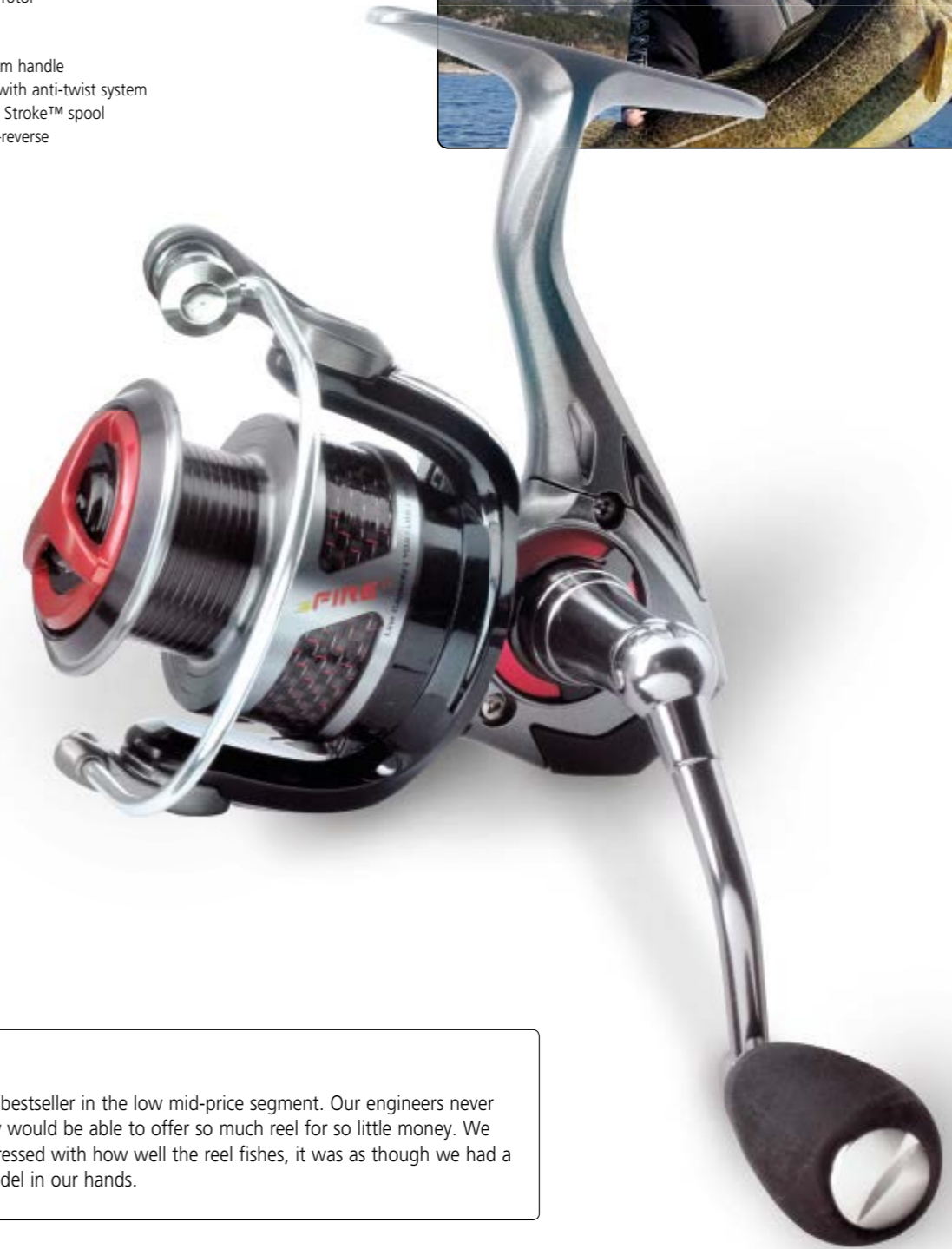

**ULTRAX FD**

An affordable front-drag reel from Quantum. Slender housing, US Quantum reel technology for novices. Classic all-round spinning reel range for all spinning techniques, from light trout fishing to soft lure sport and spoon fishing for pike and salmon.



Code	Model	m / mm	Gear Ratio	Retrieve	BB	Drag F.	Weight
0312 015	515	220 / 0,15	5,2:1	63 cm	5	2,7 kg / 6 lbs	220 g
0312 020	520	200 / 0,25	5,2:1	69 cm	5	4,5 kg / 10 lbs	271 g
0312 030	530	210 / 0,25	5,2:1	72 cm	5	4,5 kg / 10 lbs	280 g
0312 040	540	260 / 0,30	4,8:1	75 cm	5	5,4 kg / 12 lbs	405 g

Spare Spool	Model
0987 056	Sp. Spool Ultrax FD 515
0987 057	Sp. Spool Ultrax FD 520
0987 058	Sp. Spool Ultrax FD 530
0987 059	Sp. Spool Ultrax FD 540

**STANDARD TECHNICAL EQUIPMENT:**

- Balanced rotor, producing silky smooth action
- Robust nylon housing
- Finely adjustable front drag
- Die-cast aluminium handle
- Anti-twist line roller
- Smooth gears with even line distribution
- Aluminium Long Stroke™ spool
- ABS Nylon spare spool
- S-curve line distribution
- Continuous anti-reverse
- Foot Forward™ reel foot for better rod balance

**STANDARD TECHNICAL EQUIPMENT:**

- CarbonGraphite rotor
- Graphite body
- Front drag
- Folding aluminium handle
- Large line roller with anti-twist system
- Aluminium Long Stroke™ spool
- Continuous anti-reverse

**FIRE FD**

Sure to be a bestseller in the low mid-price segment. Our engineers never thought they would be able to offer so much reel for so little money. We were so impressed with how well the reel fishes, it was as though we had a high-end model in our hands.



Code	Model	m / mm	Gear Ratio	Retrieve	BB	Drag F.	Weight
0290 015	1015	105 / 0,24	5,2:1	60 cm	10	2,0 kg / 4,5 lbs	203 g
0290 020	1020	130 / 0,26	5,2:1	64 cm	10	5,0 kg / 11 lbs	237 g
0290 030	1030	170 / 0,26	5,2:1	70 cm	10	5,0 kg / 11 lbs	254 g
0290 040	1040	245 / 0,29	5,2:1	78 cm	10	6,8 kg / 15 lbs	261 g

Spare Spool	Model	Material
0987 310	Sp.Spool Fire FD1015	Alu
0987 311	Sp.Spool Fire FD1020	Alu
0987 312	Sp.Spool Fire FD1030	Alu
0987 313	Sp.Spool Fire FD1040	Alu





NEW

### TRAX II

The Quantum Trax II now offers even more performance for your money. You will clearly feel the finely-tuned gears and perfect balance. The new handle shape, specially designed for Quantum, ensures improved power transfer and ergonomics.



#### STANDARD TECHNICAL EQUIPMENT:

- Balanced rotor, producing silky smooth action
- Finely adjustable front drag
- Aluminium Long Stroke™ spool
- Spare spool
- S-curve line distribution
- Continuous anti-reverse

### HYPERCAST TP

The Hypercast TP is a reel in the mid-price segment developed for the ambitious angler. With ultra-smooth action. The robust, reliable and particularly finely adjustable front drag will satisfy even the most discerning anglers.



#### STANDARD TECHNICAL EQUIPMENT:

- Balanced rotor, producing silky smooth action
- Housing produced in aluminium to be completely distortion-free
- Large-surface multi-disc front drag system with carbon discs
- Anti-twist line roller
- Aluminium spool with hardened front edge for longer casting distances
- S-curve line distribution



Code	Model	m / mm	Gear Ratio	Retrieve	BB	Drag F.	Weight	Spare Spool	Model
0362 015	615	120 / 0,20	5,1:1	60 cm	6	3 kg / 6,6 lbs	208 g	0987 363	Sp.Spool Trax II 615
0362 020	620	240 / 0,20	5,0:1	69 cm	6	6 kg / 13,2 lbs	260 g	0987 364	Sp.Spool Trax II 620
0362 030	630	240 / 0,20	5,0:1	71 cm	6	6 kg / 13,2 lbs	264 g	0987 365	Sp.Spool Trax II 630
0362 040	640	200 / 0,30	4,6:1	75 cm	6	7,5 kg / 16,5 lbs	374 g	0987 366	Sp.Spool Trax II 640



Code	Model	m / mm	Gear Ratio	Retrieve	BB	Drag F.	Weight	Spare Spool	Model
0358 010	810	140 / 0,20	5,2:1	57 cm	8	2,5 kg / 5,5 lbs	190 g	0987 429	Sp.Spool Hypercast 810 TP
0358 020	820	195 / 0,25	5,2:1	65 cm	8	5,5 kg / 12,0 lbs	220 g	0987 430	Sp.Spool Hypercast 820 TP
0358 030	830	220 / 0,28	5,2:1	71 cm	8	5,5 kg / 12 lbs	245 g	0987 431	Sp.Spool Hypercast 830 TP
0358 040	840	250 / 0,30	5,2:1	77 cm	8	5,5 kg / 12 lbs	310 g	0987 432	Sp.Spool Hypercast 840 TP



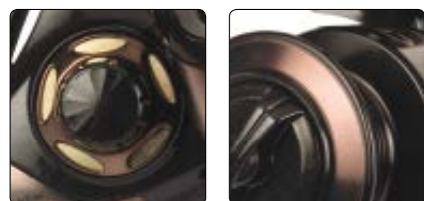

STANDARD TECHNICAL EQUIPMENT:

- Balanced rotor, producing silky smooth action
- Compact housing design
- Finely adjustable front drag
- Performance Tuned Power Handle
- Aluminium Long Stroke™ spool
- Spare spool
- S-curve line distribution
- Continuous anti-reverse



NEW

CENTEX

A renowned name in the Quantum mid-price segment: Centex! Besides the more than rock solid interior, our testers were particularly impressed by the super-slim, compact housing made from fibre-reinforced nylon material. The finely-tuned gears and optimal gear ratio for the reel size enable perfect retrieve action. The handle, which has been newly developed by Quantum, ensures extremely comfortable handling even on long sessions.



Code	Model	m / mm	Gear Ratio	Retrieve	BB	Drag F.	Weight	Spare Spool	Model
0363 015	815	120 / 0,20	5,1:1	60 cm	8	3 kg / 6,6 lbs	205 g	0987 367	Sp.Spool Centex 815
0363 020	820	200 / 0,20	5,0:1	69 cm	8	6 kg / 13,3 lbs	257 g	0987 368	Sp.Spool Centex 820
0363 030	830	240 / 0,20	5,0:1	71 cm	8	6 kg / 13,2 lbs	261 g	0987 369	Sp.Spool Centex 830
0363 040	840	200 / 0,30	4,6:1	75 cm	8	7,5 kg / 16,5 lbs	371 g	0987 370	Sp.Spool Centex 840

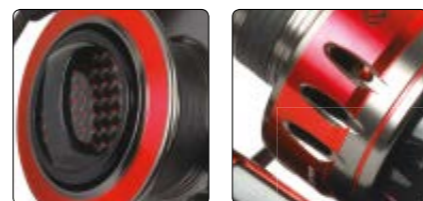

NEW



VANTEX

A fantastic reel series in the Quantum range: The reels impress with their ultra-light weight, highly pleasant, silky smooth gear action and stylish design. With 10 ball bearings, the reel has high-class features for the price segment. The outstanding performance data is achieved using the finest components, such as high-quality drag discs and a rotor in a skeleton design as well as the new ergonomic handle for perfect comfort. Available in all the most popular sizes for freshwater spinning. Whether perch fishing with a size 20 'mini-reel', or using wobblers for pike with a size 40 fighting machine, the Vantex is always a reliable partner.



Code	Model	m / mm	Gear Ratio	Retrieve	BB	Drag F.	Weight	Spare Spool	Model
0364 020	1020	200 / 0,20	5,0:1	69 cm	10	6 kg / 13,3 lbs	267 g	0987 372	Sp.Spool Vantex 1020
0364 030	1030	240 / 0,20	5,0:1	71 cm	10	6 kg / 13,3 lbs	271 g	0987 373	Sp.Spool Vantex 1030
0364 040	1040	200 / 0,30	4,6:1	75 cm	10	7,5 kg / 16,5 lbs	381 g	0987 374	Sp.Spool Vantex 1040

STANDARD TECHNICAL EQUIPMENT:

- Electronically balanced lightweight rotor (LWR)
- Compact housing design
- Finely adjustable front drag
- Folding aluminium handle
- Robust power gears
- Perforated aluminium Long Stroke™ spool
- Spare spool
- S-curve line distribution
- Multistop anti-reverse clutch

kompletný cenník na [www.SPORTS.sk](http://www.SPORTS.sk), výhradný distribútor pre SR: SPORTS s.r.o.



STANDARD TECHNICAL EQUIPMENT:

- Balanced rotor, producing silky smooth action
- Finely adjustable front drag
- Thick bail arm for optimal balance
- Reel Engine Design
- Perforated aluminium Long Stroke™ spool
- S-curve line distribution
- Continuous anti-reverse
- Foot Forward™ reel foot for better rod balance



NEW



DRIVE

A dream high-performance spinning reel range with extremely low production tolerances for an optimal, smooth action and long service life. This type of reel is primarily used with very low diameter braided lines, e.g. for drop shot fishing, soft lure fishing or twitching. That is why it is also available in the smaller sizes 5 and 10 as well as the standard medium sizes. The Drive employs the Reel Engine concept exclusively developed by Quantum, as used in the popular Quantum Throttle.



Code	Model	m / mm	Gear Ratio	Retrieve	BB	Drag F.	Weight
0370 005	DR05	70 / 0,20	5,7:1	61 cm	8	2,7 kg / 6 lbs	154 g
0370 010	DR10	115 / 0,20	5,3:1	69 cm	9	2,7 kg / 6 lbs	194 g
0370 020	DR20	140 / 0,26	5,2:1	71 cm	9	4,5 kg / 10 lbs	258 g
0370 030	DR30	165 / 0,26	5,2:1	76 cm	9	5,5 kg / 12 lbs	264 g

Spare Spool	Model	Material
0987 555	Sp.Spool Drive DR05	Alu
0987 556	Sp.Spool Drive DR10	Alu
0987 557	Sp.Spool Drive DR20	Alu
0987 558	Sp.Spool Drive DR30	Alu



STANDARD TECHNICAL EQUIPMENT:

- CarbonGraphite rotor
- Robust aluminium body
- Finely adjustable front drag
- Ergonomic handle and stainless steel components
- Anti-twist line roller
- Smooth gears with even line distribution
- Perforated aluminium spool
- S-curve line distribution
- Continuous anti-reverse
- Foot Forward™ reel foot for better rod balance

New size available!

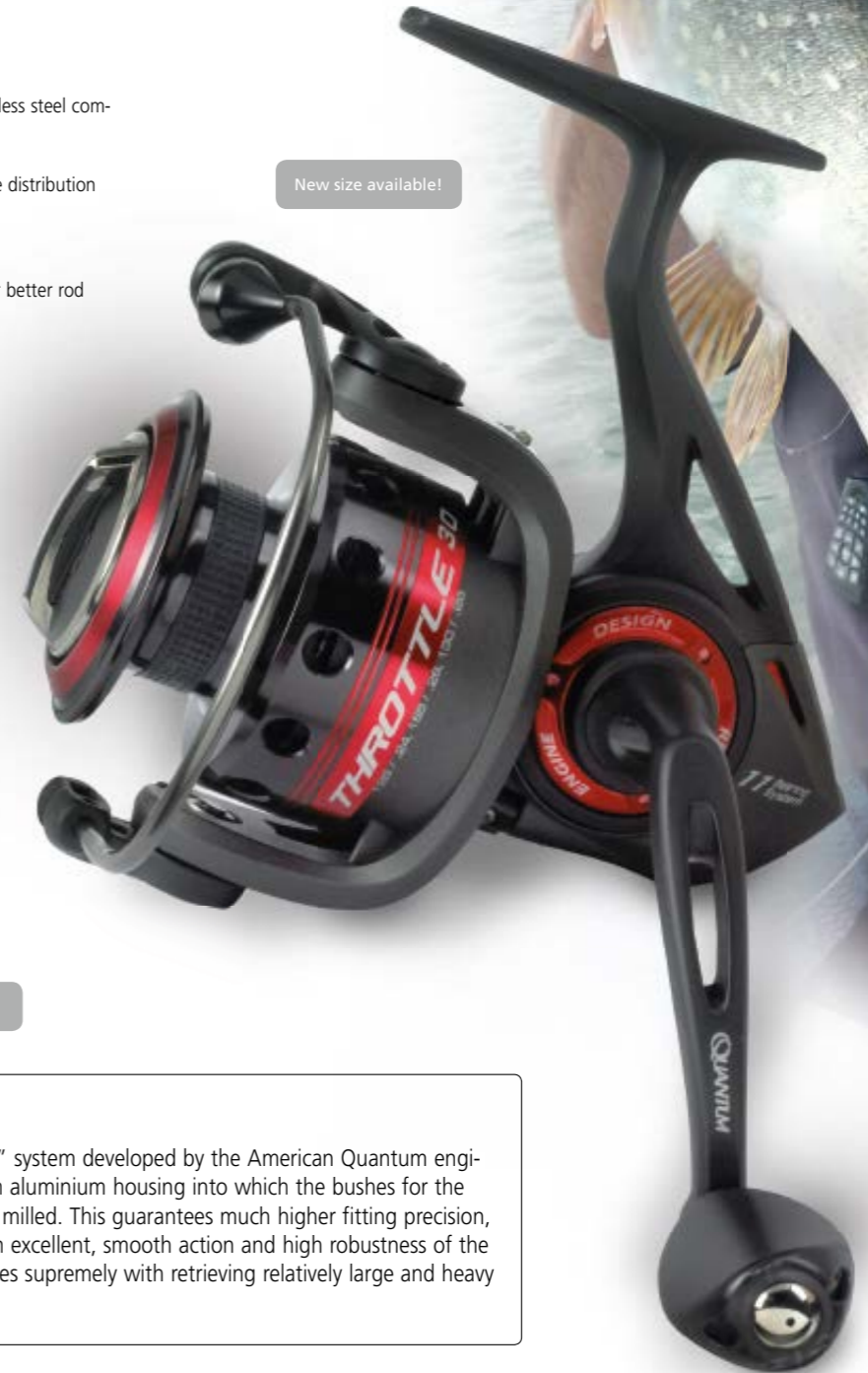

Bestseller 2017!

THROTTLE

The new "Reel Engine" system developed by the American Quantum engineers is based upon an aluminium housing into which the bushes for the axles are subsequently milled. This guarantees much higher fitting precision, which is reflected in an excellent, smooth action and high robustness of the reel. The reel even copes supremely with retrieving relatively large and heavy lures all day long.



Code	Model	m / mm	Gear Ratio	Retrieve	BB	Drag F.	Weight
0357 010	TH 10	115 / 0,20	5,3:1	61 cm	11	3,5 kg / 7,5 lbs	210 g
0357 020	TH 20	160 / 0,24	5,2:1	72 cm	11	4,5 kg / 10 lbs	263 g
0357 030	TH 30	195 / 0,24	5,2:1	81 cm	11	4,5 kg / 10 lbs	274 g
0357 040	TH 40	180 / 0,30	5,3:1	89 cm	11	5,9 kg / 13 lbs	281 g
0357 050	TH 50	210 / 0,30	5,3:1	92 cm	11	6,4 kg / 14 lbs	305 g

Spare Spool	Model	Material
0987 423	Sp.Spool Throttle TH 10	
0987 424	Sp.Spool Throttle TH 20	
0987 425	Sp.Spool Throttle TH 30	
0987 550	Sp.Spool Throttle TH 40	Alu
0987 551	Sp.Spool Throttle TH 50	Alu





STANDARD TECHNICAL EQUIPMENT:

- Electronically balanced lightweight rotor (LWR)
- Finely adjustable front drag
- Finely adjustable run control system
- Non-twist line roller
- Robust power gears
- Aluminium Long Stroke™ spool
- Spare spool
- S-curve line distribution
- Continuous anti-reverse

NEW



MR. PIKE THE RELEASER

Two first-class free-spool reels that do exactly what you expect of them at the crucial moment in an angling session: allow the line to run 'free' and unobstructed on a bite! That is why we have called these fixed-spool reels in the Mr. Pike Range 'The Releaser' because they release the line directly when necessary. The free run can be adjusted depending the current and wind. The reel is available in two sizes: a very small, compact size 420 version for light predator fishing with baitfish for zander or eel. And a large size 460 version for heavy-duty pike sport with a long-cast weight or large float rig! Both models are equipped with 4 high-quality stainless steel ball bearings and the special S-curve line distribution system guarantees optimal retrieval of the main line onto the metal long-cast spool.



Code	Model	m / mm	Gear Ratio	Retrieve	BB	Drag F.	Weight
0545 420	420	140 / 0,25	5,0:1	69 cm	4	4 kg / 8,8 lbs	187 g
0545 460	460	300 / 0,35	4,6:1	88 cm	4	7 kg / 15,4 lbs	459 g

Spare Spool	Model	Material
0987 450	Sp.Spool Mr. Pike The Releaser 420	Nylon
0987 451	Sp.Spool Mr. Pike The Releaser 460	Nylon

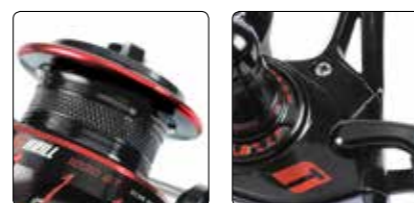

STANDARD TECHNICAL EQUIPMENT:

- Compact housing design
- Finely adjustable front drag
- Finely adjustable run control system
- CNC stainless steel handle
- Anti-twist line roller
- Continuous anti-reverse



THRILL BT

Many anglers do not appreciate the strengths of a free spool reel and not only when it comes to carp fishing. Whether trolling for pike or specimen fishing for eel, trout or zander, the run control function is unbeatable on many waters. When the run control function is enabled, the fish can take like without resistance but as soon as the angler strikes and the thrilling fight begins, the reliable drag of this aesthetically designed reel kicks in.



Code	Model	m / mm	Gear Ratio	Retrieve	BB	Drag F.	Weight
0348 030	1030	140 / 0,30	5,1:1	75 cm	10	6,0 kg / 13 lbs	336 g
0348 040	1040	180 / 0,35	4,8:1	80 cm	10	6,0 kg / 13 lbs	407 g
0348 050	1050	230 / 0,35	4,8:1	88 cm	10	8,0 kg / 18 lbs	414 g
0348 060	1060	220 / 0,40	4,8:1	92 cm	10	10,0 kg / 22 lbs	421 g

Spare Spool	Model	Material
0987 415	Sp. Spool Thrill 1030 BT	Alu
0987 416	Sp. Spool Thrill 1040 BT	Alu
0987 417	Sp. Spool Thrill 1050 BT	Alu
0987 418	Sp. Spool Thrill 1060 BT	Alu



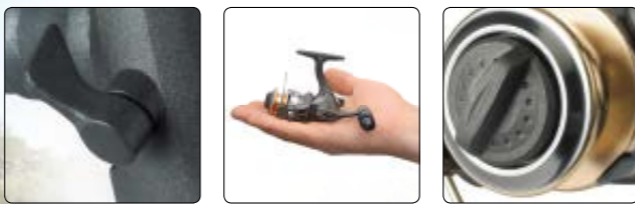

**CENTEX MICRO FD**

Finer fishing means more success. This ultra-compact Quantum reel has been developed for thin lines and is, therefore, designed for ultra-light applications. Available in two sizes, each with front drag.



Code	Model	m / mm	Gear Ratio	Retrieve	BB	Drag F.	Weight
0295 005	305	150 / 0,10	4.8:1	48 cm	3	2,5 kg / 5,5 lbs	105 g
0295 010	310 LL	170 / 0,20	5.0:1	55 cm	3	2,5 kg / 5,5 lbs	145 g

**STANDARD TECHNICAL EQUIPMENT:**

- Balanced rotor, producing silky smooth action
- Finely adjustable front drag
- Aluminium spool
- Spare spool
- S-curve line distribution

Spare Spool	Model	Material
0987 338	Sp.Spool Centex Micro FD305	Alu
0987 339	Sp.Spool Centex Micro FD310 LL	Alu



**STANDARD TECHNICAL EQUIPMENT:**

- Balanced rotor, producing silky smooth action
- Graphite body
- Large-surface multi-disc front drag system
- CNC stainless steel handle
- Anti-twist line roller
- Robust worm shaft power gears
- Aluminium Long Stroke™ spool

**WORLD CHAMPION SURF SLD**

You can make things well. And you can make them slightly better. Quantum has gone a step further with the new World Champion Surf with extra slow spool stroke! The perfect fighting machine for the surf angler who is only satisfied with the best of the best. The long-cast spool enables maximum casting distances. The gears are uncompromising in their strength, enabling the angler to fight fish for hours or reel in rigs for bait checks without tiring. Thanks to the slow spool stroke, line distribution is also of the highest standard, allowing the thinnest braids to be used and flow effortlessly from the spool.



Code	Model	m / mm	Gear Ratio	Retrieve	BB	Drag F.	Spare Spool	Weight
0351 065	865	270 / 0,32	4,9:1	102 cm	8	10,0 kg / 22 lbs	0987 113 / 0987 114	695 g
0351 080	880	270 / 0,35	4,9:1	102 cm	8	10,0 kg / 22 lbs	0987 115 / 0987 116	725 g

Spare Spool	Model	m / mm
0987 113	shallow	270 / 0,32
0987 114	deep	350 / 0,35
0987 115	shallow	270 / 0,35
0987 116	deep	370 / 0,35



kompletný cenník na [www.SPORTS.sk](http://www.SPORTS.sk), výhradný distribútor pre SR: SPORTS s.r.o.





### MANIAC DURACAST SURF

Top surf reel for the ambitious surf angler. The Maniac Duracast Surf impressively lives up to this description. The model boasts a high degree of functionality. Besides the optimised long-cast spool, the reel impresses with its high-performance wormshaft gears and ergonomic handle knob. A high degree of salt water resistance is obviously essential.

#### STANDARD TECHNICAL EQUIPMENT:

- Balanced rotor, producing silky smooth action
- Graphite body
- Finely adjustable front drag
- Stainless steel handle
- Anti-twist line roller
- Robust worm shaft power gears
- Wormshaft oscillation system



Code	Model	m / mm	Gear Ratio	Retrieve	BB	Drag F.	Weight	Spare Spool	Model	m / mm
0352 070	570	300 / 0,32	4,6:1	94 cm	5	10 kg / 22 lbs	635 g	0987 119	Sp.Spool Maniac Duracast Surf 570	300 / 0,32



#### STANDARD TECHNICAL EQUIPMENT:

- Balanced rotor, producing silky smooth action
- Front drag
- Ergonomically designed handle knob for optimal power transfer
- Robust power gears
- Shallow aluminium spool
- Spare spool
- Continuous anti-reverse

### SMART MOTION SURF

Top surf reels do not have to cost a fortune, the Smart Motion Surf is proof of that. The model offers a high degree of functionality. In addition the optimised long cast spool, the powerful transmission and ergonomic handle knob are bound to impress. High resistance to saltwater is an essential feature of the model.



Code	Model	m / mm	Gear Ratio	Retrieve	BB	Drag F.	Spare Spool	Weight	Spare Spool	Model	m / mm	Material
0256 060	660	200 / 0,30	4.9:1	94 cm	6	7,7 kg / 17 lbs	0987 005 / 0987 008	544 g	0987 005	shallow	450 / 0,30	Alu
0256 070	670	450 / 0,30	4.7:1	98 cm	6	11,8 kg / 26 lbs	0987 009 / 0987 014	779 g	0987 008	deep	600 / 0,30	Alu
									0987 009	shallow	230 / 0,30	Alu
									0987 014	deep	360 / 0,30	Alu





STANDARD TECHNICAL EQUIPMENT:

- Balanced rotor, producing silky smooth action
- Front drag
- Ergonomically designed handle knob for optimal power transfer
- Robust power gears
- Deep aluminium spool
- Spare spool
- Continuous anti-reverse

MANIAC FD

A medium sized fixed spool reel with front drag for all round sea fishing, which will be of interest to a vast number of anglers. With a deep aluminium spool to accept larger line volumes. The S-curve oscillation system guarantees optimal line distribution and is far from a standard feature in this price segment. Available in three sizes: #40, #60 und #70.



Code	Model	m / mm	Gear Ratio	Retrieve	BB	Drag F.	Weight
0262 040	440	200 / 0,30	5.5:1	83 cm	4	5,9 kg / 13 lbs	366 g
0262 060	460	230 / 0,40	5.5:1	103 cm	4	6,8 kg / 15 lbs	416 g
0262 070	470	320 / 0,35	4.5:1	93 cm	4	10,0 kg / 22 lbs	690 g

Spare Spool	Model	Material
0987 237	Sp.Spool Maniac FD440	Alu
0987 238	Sp.Spool Maniac FD460	Alu
0987 239	Sp.Spool Maniac FD470	Alu



EXO BAITCASTER

We set our engineers the challenge of making the Exo Baitcaster as light as they possibly could without compromising on performance. The solution was relatively simple: We called it "metal only where necessary". The finished product is a skeleton design and the lightest Quantum Baitcaster in the company's history. At the same time, the reel is so robust that you can drive a pick-up over it, as you can see on our web site. Available in left and right-hand versions.

STANDARD TECHNICAL EQUIPMENT:

- Robust light metal body in skeleton design
- MegaDrag™ stainless steel and carbon fibre drag system
- Ultra-light handle in hardened aluminium and skeleton design with EVA handles
- Titanium-nitride-coated line roller
- PT™ gears
- Ultra-light skeleton spool
- Continuous anti-reverse
- ACS casting drag reliably prevents the line from overflowing



Code	Model	m / mm	Gear Ratio	Retrieve	BB	Drag F.	Weight
0511 101	LH EX101SPT	130 / 0,24	6.6:1	72 cm	11	6,8 kg / 15 lbs	167 g
0512 101	LH EX101HPT	130 / 0,24	7.3:1	79 cm	11	6,8 kg / 15 lbs	167 g
0511 201	LH EX201SPT	155 / 0,36	6.6:1	81 cm	11	8,2 kg / 18 lbs	192 g
0512 201	LH EX201HPT	155 / 0,36	7.3:1	89 cm	11	8,2 kg / 18 lbs	192 g
0511 301	LH EX301SPT	237 / 0,36	6.6:1	85 cm	11	8,2 kg / 18 lbs	212 g
0512 301	LH EX301HPT	237 / 0,36	7.3:1	93 cm	11	8,2 kg / 18 lbs	212 g

Spare Spool	Model	Material
0987 201	E-Spule EXO 100 LH SPT + HPT	Alu
0987 335	E-Spule EXO 200 LH SPT + HPT	Alu
0987 336	E-Spule EXO 300 LH SPT + HPT	Alu





### TOUR MG PT BAITCASTER

Sensational light baitcaster that opens up new possibilities for the angler. In Magnesium we have used an incredibly light material. However, in the past, it was often essential to treat this special metal since it corrodes more easily than aluminium, for example. That was until the Quantum engineers succeeded in developing a highly durable alloy with a high-strength coating, eliminating any risk of corrosion when used in freshwater. Now the angler can enjoy the unadulterated pleasure of presenting even light artificial lures with precision with the Tour PTi Mag.

#### STANDARD TECHNICAL EQUIPMENT:

- Ultra-light magnesium housing
- Finely adjustable, protected CSC™ front drag system (carbon drag discs)
- Ultra-light handle in hardened aluminium and skeleton design with EVA handles
- Titanium-nitride-coated line roller
- PT™ gears
- MaxCast ultra-light skeleton spool
- Continuous anti-reverse
- ACS casting drag reliably prevents the line from overflowing
- Optional flipping switch line release



Code	Model	m / mm	Gear Ratio	Retrieve	BB	Drag F.	Weight
0507 101	LH T101HPTMG	115 / 0,33	7.0:1	79 cm	11	7,3 kg / 16 lbs	151 g
0507 111	LH T101SPTMG	115 / 0,33	6.3:1	67 cm	11	7,7 kg / 17 lbs	151 g

Spare Spool	Model	Material
0987 337	Sp.Spool Tour PTi MAG LH 101	Alu

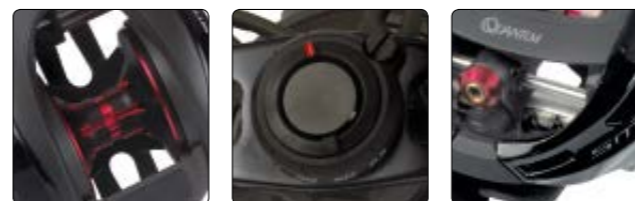

### SMOKE S3 LH 101 HPT

Smoke Baitcasters are among the most widely used top-end baitcaster reels in Europe. That is why the Quantum engineers have now developed the third generation. The spool has been enlarged in relation to the reel to offer greater line capacity and make long-range casting easier. The new "Micro-Adjust ACS4" centrifugal drag system is easily adjustable from the side and enables the angler to cast skilfully over long distances without tangling. The technology injects fun into angling, which will be reflected in your catches.



Code	Model	m / mm	Gear Ratio	Retrieve	BB	Drag F.	Weight
0528 101	Smoke S3 LH 101 HPT	138 / 0,25	7,3:1	81 cm	11	11 kg / 25 lbs	196 g
0523 100	RH 100XPTA	115 / 0,33	8,1:1	89 cm	11	4,1 kg / 9 lbs	182 g

Spare Spool	Model	Material
0987 910	Sp. Spool Smoke S3 LH 101 HPT	Alu
0987 353	Sp.Spool Smoke Speed Freak RH/LH	



#### STANDARD TECHNICAL EQUIPMENT:

- Aluminium X-Frame Design
- Finely adjustable CSC™ front drag system (carbon drag discs)
- Performance Tuned Power Handle
- Precision Performance Tuned Gears
- Oversized Spool Technology
- Dura-Lok Clutch
- ACS casting drag reliably prevents the line from overflowing
- Performance Tuned High Speed Bearings
- Performance Tuned Hot Sauce Lubrication





### SMOKE INSHORE

For multiplier fans among sea spinning anglers, there is now a saltwater-resistant version of the Smoke. The Inshore is made from particularly corrosion-resistant aluminium while the bearings are encapsulated for protection against saltwater.

#### STANDARD TECHNICAL EQUIPMENT:

- Ultra-light aluminium body
- MegaDrag™ stainless steel and carbon fibre drag system
- CNC stainless steel handle
- MaxCast ultra-light skeleton spool
- Continuous anti-reverse
- ACS casting drag reliably prevents the line from overflowing



Code	Model	m / mm	Gear Ratio	Retrieve	BB	Drag F.	Weight
0526 101	LH SL101HPTSA	115 / 0,33	7,3:1	79 cm	7	5,2 kg / 11,4 lbs	190 g

Spare Spool	Model
0987 359	Sp. Spool Smoke Inshore

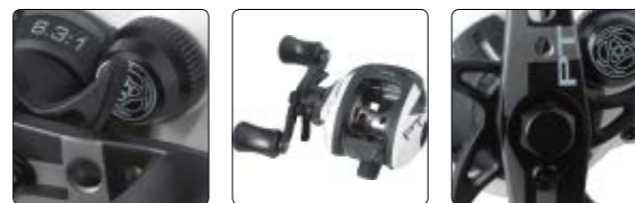

### ACCURIST

Extremely attractive range of baitcasters. The colours match the Accurist rods and Accurist spinning reels. Reliable workhorses in the mid-price segment with outstanding performance values. The Accurist is available as a right-handed model or in a left-handed version.

#### STANDARD TECHNICAL EQUIPMENT:

- MegaDrag™ stainless steel and carbon fibre drag system
- PT™ gears
- MaxCast ultra-light skeleton spool
- Continuous anti-reverse
- DynaMag magnetic cast control, reliably prevents line tangles on the cast
- Optional flipping switch line release



Code	Model	m / mm	Gear Ratio	Retrieve	BB	Drag F.	Weight
0524 101	LH 101HPTA	100 / 0,33	7,0:1	71 cm	7	5,2 kg / 11,4 lbs	233 g
0524 100	RH 100HPTA	100 / 0,33	7,0:1	71 cm	7	5,2 kg / 11,4 lbs	233 g

Spare Spool	Model
0987 356	Sp. Spool Accurist LH HPT
0987 355	Sp. Spool Accurist RH HPT





**ICON**

Aesthetically designed reel in the mid-price segment whose strengths may not be fully appreciated at first glance. The Icon is equipped with 11 ball bearings, providing an incredibly smooth action. The frame comprises CNC-machined housing, making the reel robust and guaranteeing the angler many years of fishing fun. The finely adjustable centrifugal drag can be quickly adjusted externally when the angler switches baits.

**STANDARD TECHNICAL EQUIPMENT:**

- Solid 1-piece aluminium frame
- Oversized multi-stack drag system
- Perforated aluminium spool
- Continuous anti-reverse
- ACS casting drag reliably prevents the line from overflowing



Code	Model	m / mm	Gear Ratio	Retrieve	BB	Drag F.	Weight
0519 100	IC100HPT	125 / 0,24	7,0:1	70 cm	11	7 kg / 16 lbs	220 g
0519 101	IC101HPT	125 / 0,24	7,0:1	70 cm	11	7 kg / 16 lbs	220 g

Spare Spool	Model
0987 426	Sp.Spool IC100HPT
0987 427	Sp.Spool IC101HPT

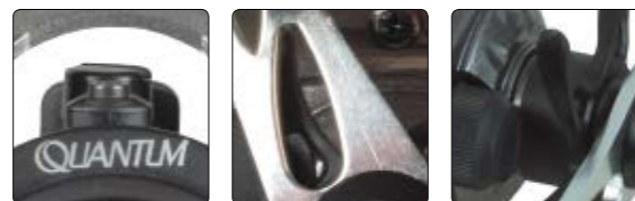

**ULTREX CAST**

The affordable entry-level option to the Quantum Baitcaster world is designed to match the successful Ultrex rod series. The Ultrex Cast impresses as much as the rods and proves that affordable tackle these days can rival many expensive competitors in terms of comfort.

**STANDARD TECHNICAL EQUIPMENT:**

- Powerful handle
- Powerful gears
- Aluminium spool
- Continuous anti-reverse



Code	Model	m / mm	Gear Ratio	Retrieve	BB	Drag F.	Weight
0530 100	RH 100	110 / 0,25	6,1:1	46 cm	3	6,5 kg / 14 lbs	216 g
0530 101	LH 101	110 / 0,25	6,1:1	46 cm	3	6,5 kg / 14 lbs	216 g

Spare Spool	Model	Material
0987 501	Sp.Spool Ultrex Cast LH	Alu
0987 511	Sp.Spool Ultrex Cast RH	Alu





Code	Model	Length	Sections	C.W.	Tr.-Length	Weight
14105 240	Smoke Spin	2,40 m	2	3 - 35 g	1,24 m	151 g
14105 243	Smoke Spin	2,40 m	2	7 - 75 g	1,24 m	183 g
14105 245	Smoke Spin	2,40 m	2	22 - 125 g	1,24 m	224 g
14105 255	Smoke Spin	2,55 m	2	5 - 55 g	1,31 m	170 g
14105 270	Smoke Spin	2,70 m	2	5 - 55 g	1,39 m	175 g
14105 271	Smoke Spin	2,70 m	2	7 - 75 g	1,39 m	183 g
14105 272	Smoke Spin	2,70 m	2	10 - 105 g	1,39 m	194 g

**SMOKE SPIN**  
 Visually, the Smoke Spin series is slender and elegant. However, anybody who holds these rods in their hand will appreciate what they are made of – possibly the best spinning rods available on the market! The powerful, super-slim blanks leave nothing to be desired and deliver pure pleasure when fishing. Even long-range strikes and fights with monster specimens are handled masterfully by the Smoke Spin. The Smoke Spin, a spinning rod that may become addictive!



Code	Model	Length	Sections	C.W.	Tr.-Length	Weight
14127 255	Smoke Spin Traveller	2,55 m	5	5 - 55 g	0,56 m	165 g
14127 270	Smoke Spin Traveller	2,70 m	5	10 - 105 g	0,59 m	185 g



**SMOKE SPIN TRAVELLER**  
 The popular Smoke Spin is now also available as a five-piece travel rod. Despite its many sections, the rod impresses similarly to its two-piece sibling with its lightning-fast blank and light weight. Once you have held the rod in your hand, you would never believe that it actually consisted of five sections. The travel rod is available in the most popular casting weight classes of 5-55g and 10-105g, opening up a wide range of uses to the angler on the next fishing holiday. The rod is supplied in a robust transport case that will easily fit into any suitcase.



Code	Model	Length	Sections	C.W.	Tr.-Length	Weight
14106 180	Smoke Vertical	1,80 m	1	30 g	1,80 m	129 g
14003 180	Smoke Vertical TR	1,80 m	1	30 g	1,80 m	129 g

**SMOKE VERTICAL**  
 Just like its big sister, the Smoke Vertical is bound to make the heart of every spinning angler beat faster. The phenomenal blank transmits every movement to the lure and ensures even cautious bites are felt through the handle. The perfect partner when it comes to vertical fishing for predators.



Code	Model	Length	Sections	C.W.	Tr.-Length	Weight
14128 180	Smoke Vertical Inline	1,80 m	1	30 g	1,80 m	138 g

**SMOKE VERTICAL INLINE**  
 Supreme vertical rod with optimal technical finesse. The internal line guide provides maximum weight saving and transmits all signals optimally from the bait via the blank to the angler's arm. Vertical fishing has never been so sensitive!







Code	Model	Length	Sections	C.W.	Tr.-Length	Weight
14001 185	Pelagic	1,85 m	1	80 g	1,84 m	160 g

**PELAGIC**  
 The Quantum Pelagic is designed for big pike and zander sport. The rod was developed by our team angler Fredrik Harbort. Specimen zander can be hooked securely thanks to the powerful action. The Pelagic has a practically continuous action but is not too stiff, ensuring that ferocious opponents such as particularly big pike are not lost during a fight. Mid-water angling in open water and vertical fishing for big zander are among the rod's particular strengths. However, with its special action, the Pelagic is an all-rounder ideally suited to light jerkbait and swimbait sport for pike, black bass and other predators.



Code	Model	Length	Sections	C.W.	Tr.-Length	Weight
13901 240	Cabo Spin	2,40 m	2	150 g	1,76 m	310 g
13901 241	Cabo Spin	2,40 m	2	250 g	1,76 m	350 g

**CABO SPIN**  
 Dozens of seagulls screech above the sea. Thousands of panicking sardines jump out of the water, which seems to be literally boiling. Pure adrenaline! Tuna feed in an insatiable frenzy. In recent years, the Mediterranean has provided this spectacle with increasing frequency, making spinning for hunting tuna one of the most popular angling techniques. These new Blu-Water sea spinning rods have been pushed to the limits in endless rounds of testing. The results are simply fantastic. The extremely powerful high-modulus carbon blanks are reliable partners for breaking the resistance of tuna. At the same time, however, the top section is sufficiently progressive to punch out stickbaits and hard lures effortlessly over long distances.



kompletný cenník na [www.SPORTS.sk](http://www.SPORTS.sk), výhradný distribútor pre SR: SPORTS s.r.o.





Code	Model	Length	Sections	C.W.	Tr.-Length	Weight
14700 225	Iron Spin	2,25 m	2	20 g	1,18 m	119 g
14700 245	Iron Spin	2,45 m	2	24 g	1,28 m	132 g
14700 275	Iron Spin	2,75 m	2	28 g	1,43 m	161 g
14700 300	Iron Spin	3,00 m	2	43 g	1,56 m	187 g

**IRON SPIN**  
 Aggressive spinning rod series for various forms of lure fishing at sea. The robust blanks impress with a very fast action, allowing the angler to react to even brief knocks with an immediate strike. The high-quality yet inconspicuous design has already won countless friends in the test phase.



Code	Model	Length	Sections	C.W.	Tr.-Length	Weight
14701 245	Iron Jig	2,45 m	2	72 g	1,26 m	177 g
14701 275	Iron Jig	2,75 m	2	72 g	1,42 m	209 g

**IRON JIG**  
 Aggressive spinning rod series for various forms of lure fishing at sea. Particularly suited to use with soft plastic lures. The robust blanks impress with a very fast action, allowing the angler to react to even brief knocks with an immediate strike. The high-quality yet inconspicuous design has already won countless friends in the test phase.



Code	Model	Length	Sections	C.W.	Tr.-Length	Weight
13904 240	Iron Heavy Jig	2,40 m	2	150 g	1,25 m	216,5 g
13904 270	Iron Heavy Jig	2,70 m	2	150 g	1,40 m	264,5 g
13904 300	Iron Heavy Jig	3,00 m	2	150 g	1,56 m	271,5 g

**IRON HEAVY JIG**  
 The Iron Heavy Jig was developed for use with heavy lures in salt water. Whether you prefer to fish with a pirkor or soft lure, this rod will bring you countless hours of enjoyment. The firm blank guarantees both excellent bite indication and adequate power for fighting even the most ferocious opponents.



Code	Model	Length	Sections	C.W.	Tr.-Length	Weight
1069 195	Blu Spin	1,95 m	2	10 - 35 g	1,93 m	162 g
1069 210	Blu Spin	2,10 m	2	7 - 35 g	1,79 m	175 g
1069 211	Blu Spin	2,10 m	2	10 - 50 g	1,79 m	188 g
1069 225	Blu Spin	2,25 m	2	7 - 35 g	1,92 m	183 g
1069 226	Blu Spin	2,25 m	2	20 - 50 g	1,92 m	201 g

**BLU SPIN**  
 Saltwater spinning is becoming increasingly popular – the combination of surging waves and lively predators offer a fantastic adventure. Quantum is always ready for new challenges and the new Blu Spinning range for saltwater fishing is sure to attract the interest of many ambitious, forward-thinking anglers all over Europe. The range stands out with its ultra-light blanks with fast and medium-fast actions in high-quality carbon fibre and a variety of lengths. All components are carefully selected and corrosion resistant. The rods also impress with their modern look. Yet again, Quantum has proven its expertise when it comes to developing outstanding spinning rods.



kompletný cenník na [www.SPORTS.sk](http://www.SPORTS.sk), výhradný distribútor pre SR: SPORTS s.r.o.





Code	Model	Length	Sections	C.W.	Tr.-Length	Weight
14210 210	Throttle Spin	2,10 m	2	3 - 14 g	1,09 m	130 g
14210 211	Throttle Spin	2,10 m	2	12 - 44 g	1,09 m	132 g
14210 240	Throttle Spin	2,40 m	2	6 - 26 g	1,24 m	144 g
14210 241	Throttle Spin	2,40 m	2	12 - 44 g	1,24 m	160 g
14210 242	Throttle Spin	2,40 m	2	18 - 74 g	1,24 m	163 g
14210 270	Throttle Spin	2,70 m	2	12 - 44 g	1,39 m	170 g
14210 271	Throttle Spin	2,70 m	2	18 - 74 g	1,39 m	179 g
14210 300	Throttle Spin	3,00 m	2	12 - 44 g	1,54 m	188 g
14210 301	Throttle Spin	3,00 m	2	18 - 74 g	1,54 m	199 g

**THROTTLE SPIN**

The new Quantum Throttle Spin is a rod series in the lower price segment that, despite the price, leaves nothing to be desired for the modern spinning angler. With its combination of high-quality components and classy lightweight designs, the rods can compete with many significantly more expensive rods in terms of weight. The classy red and black design with matt elements matches the renowned Throttle spinning reel. The value-for-money combination of a Throttle rod and Throttle reel will impress novices and professionals alike on the water.



Code	Model	Length	Sections	C.W.	Tr.-Length	Weight
14123 228	L	2,28 m	2	3 - 12 g	1,19 m	121 g
14124 210	M	2,10 m	2	7 - 23 g	1,10 m	112 g
14124 228	M	2,28 m	2	7 - 23 g	1,19 m	119 g
14124 248	M	2,48 m	2	7 - 23 g	1,29 m	142 g
14125 198	MH	1,98 m	2	13 - 35 g	1,04 m	119 g
14125 210	MH	2,10 m	2	13 - 35 g	1,09 m	130 g
14125 228	MH	2,28 m	2	13 - 35 g	1,18 m	150 g
14125 248	MH	2,48 m	2	13 - 35 g	1,27 m	168 g
14126 228	H	2,28 m	2	18 - 45 g	1,18 m	192 g
14126 248	H	2,48 m	2	18 - 45 g	1,28 m	225 g

**HYPERCAST POWER JIG**

Fast spinning rod series with lively action. Lightning-fast casting, precise bait presentation and an instant strike - with this rod series, everything is child's play. Any angler who has grown tired of his old spinning rod should take a closer look at this series.

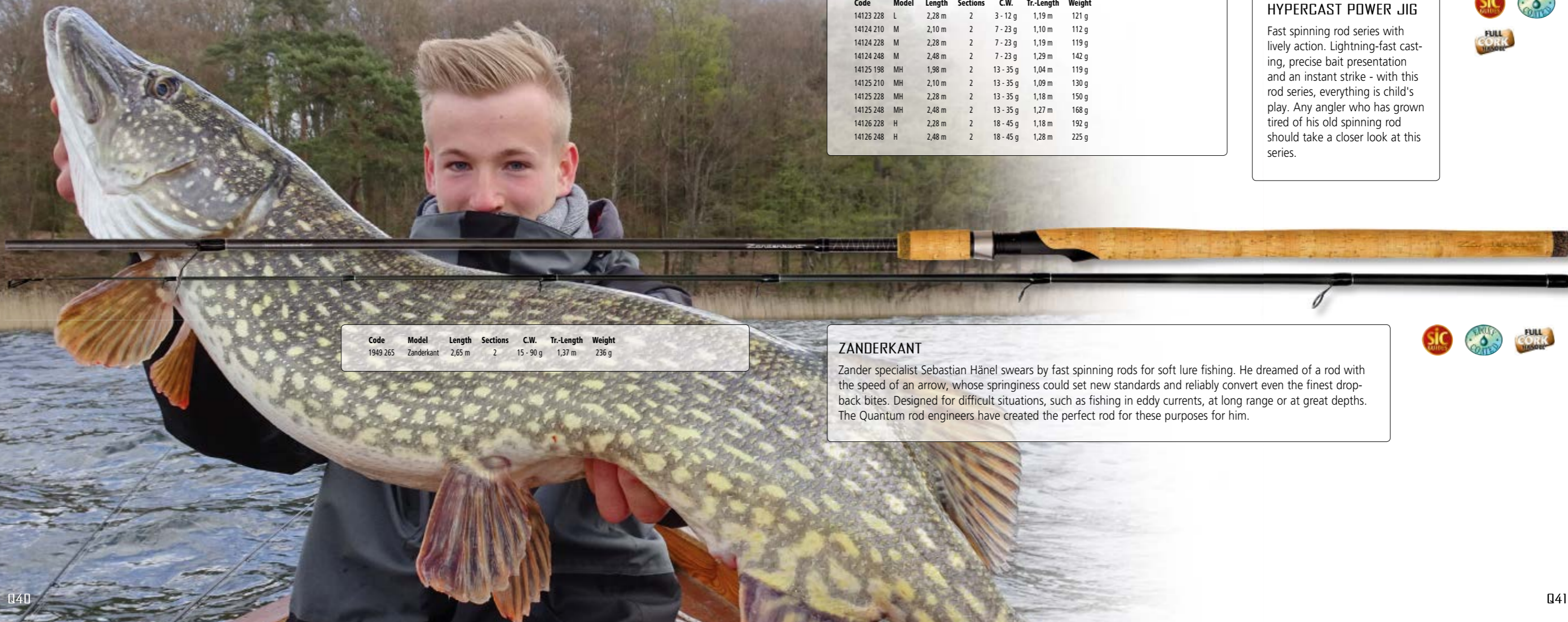

Code	Model	Length	Sections	C.W.	Tr.-Length	Weight
1949 265	Zanderkant	2,65 m	2	15 - 90 g	1,37 m	236 g

**ZANDERKANT**

Zander specialist Sebastian Hänel swears by fast spinning rods for soft lure fishing. He dreamed of a rod with the speed of an arrow, whose springiness could set new standards and reliably convert even the finest drop-back bites. Designed for difficult situations, such as fishing in eddy currents, at long range or at great depths. The Quantum rod engineers have created the perfect rod for these purposes for him.



kompletný cenník na [www.SPORTS.sk](http://www.SPORTS.sk), výhradný distribútor pre SR: SPORTS s.r.o.





Code	Model	Length	Sections	C.W.	Tr.-Length	Weight
14134 180	Spin 20	1,80 m	2	2 - 20 g	0,95 m	142 g
14134 210	Spin 20	2,10 m	2	2 - 20 g	1,10 m	160 g
14134 240	Spin 20	2,40 m	2	2 - 20 g	1,25 m	179 g
14134 270	Spin 20	2,70 m	2	2 - 20 g	1,40 m	206 g
14135 210	Spin 45	2,10 m	2	15 - 45 g	1,10 m	183 g
14135 240	Spin 45	2,40 m	2	15 - 45 g	1,25 m	214 g
14135 270	Spin 45	2,70 m	2	15 - 45 g	1,40 m	239 g
14135 300	Spin 45	3,00 m	2	15 - 45 g	1,55 m	263 g
14136 240	Spin 70	2,40 m	2	25 - 70 g	1,25 m	230 g
14136 270	Spin 70	2,70 m	2	25 - 70 g	1,40 m	253 g
14136 300	Spin 70	3,00 m	2	25 - 70 g	1,55 m	294 g

**SCALPEL SPIN**  
 A rod series for the price-conscious angler who does not want to make any compromises. Equipped with light rings with SIC inserts, the Scalpel models will bring you countless hours of enjoyment. Even our testers were immediately impressed with their light and lively blanks. The wide range of lengths and casting weights covers every conceivable situation and technology in modern predator fishing.



Code	Model	Length	Sections	C.W.	Tr.-Length	Weight
1902 180	Fire Spin	1,80 m	2	5 - 20 g	0,96 m	131 g
1902 210	Fire Spin	2,10 m	2	5 - 20 g	1,11 m	143 g
1902 240	Fire Spin	2,40 m	2	5 - 20 g	1,26 m	161 g
1902 241	Fire Spin	2,40 m	2	20 - 50 g	1,26 m	172 g
1902 242	Fire Spin	2,40 m	2	35 - 75 g	1,26 m	204 g
1902 270	Fire Spin	2,70 m	2	20 - 50 g	1,41 m	190 g
1902 271	Fire Spin	2,70 m	2	35 - 75 g	1,41 m	259 g
1902 300	Fire Spin	3,00 m	2	20 - 50 g	1,54 m	249 g
1902 301	Fire Spin	3,00 m	2	35 - 75 g	1,54 m	284 g

**FIRE SPIN**  
 A range of spinning rods for the price-conscious angler who does not want to compromise on action or equipment. The nine different Fire spinning rods are available in three different casting weights, each in three different lengths. This ensures the right solution is available for all conditions. The Fire Spin reels to complement this rod series can be found on page 18.



**HYPERCAST XTC II**  
 Modern spinning rods in an attractive price segment. The slender blank surprised the testers again and again with its liveliness. The actions are tailored to requirements, as requested by American Pro-Tour spinning anglers. Benefit from the know-how of experienced professionals.



Code	Model	Length	Sections	C.W.	Tr.-Length	Weight
14102 180	Hypercast XTC II	1,80 m	2	3 - 25 g	0,94 m	129 g
14102 210	Hypercast XTC II	2,10 m	2	3 - 25 g	1,08 m	136 g
14102 240	Hypercast XTC II	2,40 m	2	3 - 25 g	1,24 m	182 g
14103 240	Hypercast XTC II	2,40 m	2	25 - 50 g	1,24 m	195 g
14103 270	Hypercast XTC II	2,70 m	2	25 - 50 g	1,40 m	210 g
14103 300	Hypercast XTC II	3,00 m	2	25 - 50 g	1,55 m	288 g
14104 240	Hypercast XTC II	2,40 m	2	35 - 75 g	1,24 m	198 g
14104 270	Hypercast XTC II	2,70 m	2	35 - 75 g	1,40 m	264 g
14104 300	Hypercast XTC II	3,00 m	2	35 - 75 g	1,55 m	307 g



kompletný cenník na [www.SPORTS.sk](http://www.SPORTS.sk), výhradný distribútor pre SR: SPORTS s.r.o.





Code	Model	Length	Sections	C.W.	Tr.-Length	Weight
14138 200	Ultrax Cast	2,00 m	1	7 - 28 g	2,00 m	121 g

**ULTRAX CAST**  
 The new Ultrax Cast is a value-for-money casting rod for the angler who does not want to compromise on casting properties. The tip action catapults baits over incredible casting distances while providing optimal support with lure retrieval and bite detection.



Code	Model	Length	Sections	C.W.	Tr.-Length	Weight
14113 180	Ultrax Spin	1,80 m	2	20 g	0,94 m	115 g
14113 240	Ultrax Spin	2,40 m	2	20 g	1,24 m	190 g
14113 270	Ultrax Spin	2,70 m	2	20 g	1,40 m	231 g
14114 210	Ultrax Spin	2,10 m	2	35 g	1,08 m	143 g
14114 240	Ultrax Spin	2,40 m	2	35 g	1,24 m	192 g
14114 270	Ultrax Spin	2,70 m	2	35 g	1,40 m	249 g
14115 300	Ultrax Spin	3,00 m	2	45 g	1,54 m	320 g
14116 240	Ultrax Spin	2,40 m	2	50 g	1,24 m	215 g
14116 270	Ultrax Spin	2,70 m	2	50 g	1,40 m	271 g
14117 270	Ultrax Spin	2,70 m	2	70 g	1,40 m	280 g

**ULTRAX SPIN**  
 Good rods often cost a lot of money, but beginners and occasional anglers often don't want to dig too deeply into their pockets. And now they don't have to because our developers have succeeded in creating a contemporary rod series that covers all aspects of spinning without breaking the bank. Perch, zander, pike and similar should beware of these rods.



Code	Model	Length	Sections	C.W.	Tr.-Length	Weight
14118 180	Ultrax Jerk TR	1,80 m	1	100 g	1,81 m	160 g

**ULTRAX JERK TR**  
 Jerking can often produce brutal bites. And that means pure adrenaline! What the angler needs is uncompromising equipment with optimal quality and functionality. This rod impresses on both counts meaning beginners and pros alike will not want to put these rods down.



Code	Model	Length	Sections	C.W.	Tr.-Length	Weight
14137 180	Ultrax Vertical	1,80 m	2	10 - 30 g	0,94 m	115 g

**ULTRAX VERTICAL**  
 The new Ultrax Vertical was designed for price-conscious angler who still wants to take a light yet completely robust rod to the water. The sensitive tip reliably indicates even the slightest twitch to the angler. At the same time, however, the Ultrax Vertical has sufficient backbone to overcome even larger opponents.

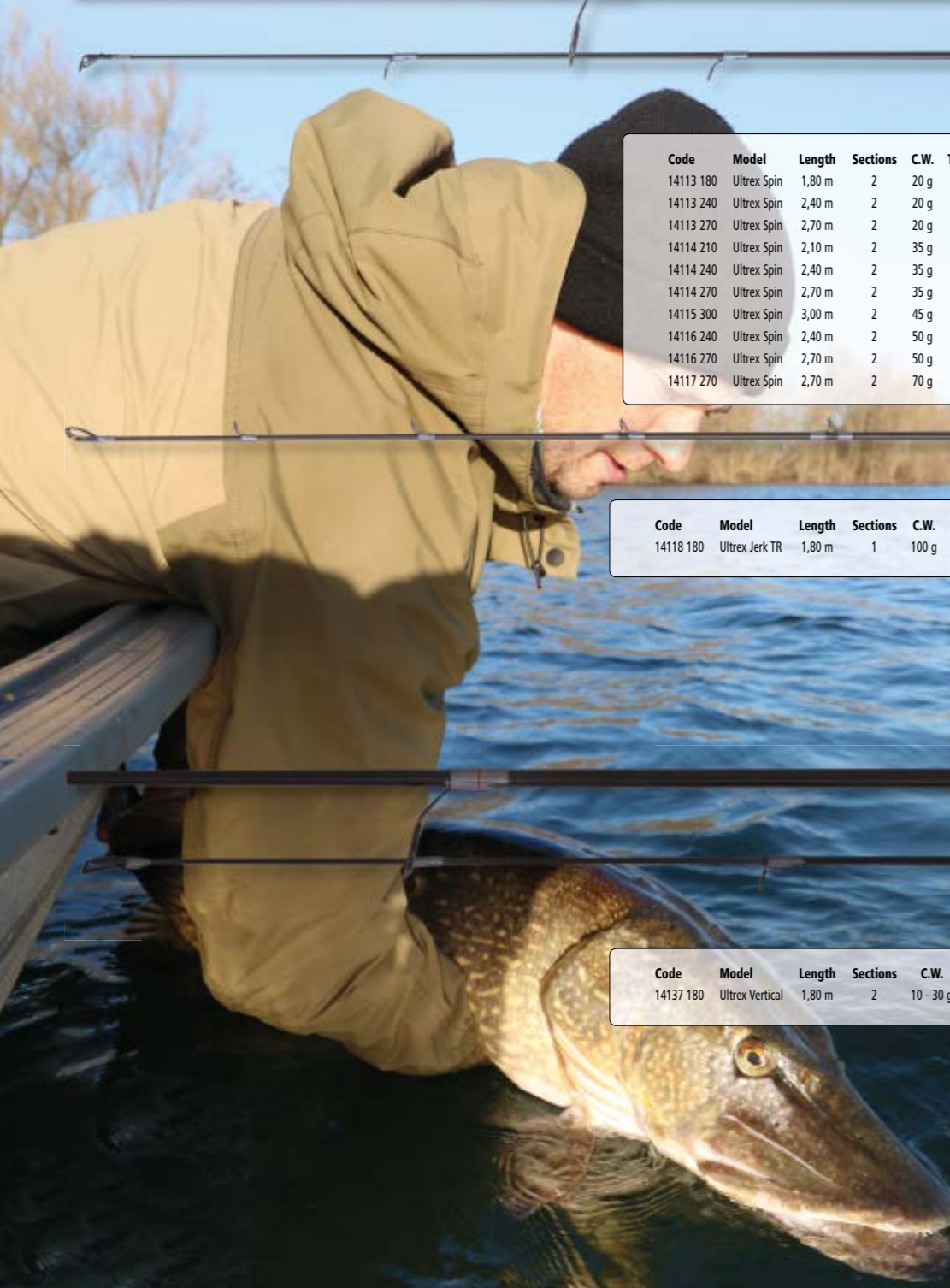





Code	Model	Length	Sections	C.W.	Tr.-Length	Weight
14120 245	Ultrax Big Bait	2,45 m	2	200 g	1,88 m	243 g

**ULTRAX BIG BAIT**  
 Optimal lure rod for heavy artificial lures, whether hard lures, jerk baits or soft baits. Pike anglers will come to love this rod for active fishing. The power from all parts of the blank on casting is astounding. At the same time, the powerful backbone will quickly break the fighting spirit of even monster specimens.



Code	Model	Length	Sections	C.W.	Tr.-Length	Weight
14122 300	Ultrax Dead Bait	3,00 m	2	3 lbs	1,55 m	362 g

**ULTRAX DEAD BAIT**  
 Special rod for fishing with deadbaits. The substantial backbone will tame even monster specimens. Despite the power of the blank, the rod sits comfortably in the hand.



Code	Model	Length	Sections	C.W.	Tr.-Length	Weight
14121 210	Ultrax Drop Shot	2,10 m	2	30 g	1,08 m	140 g

**ULTRAX DROP SHOT**  
 It is no longer a secret that drop shot fishing can produce sensational results. However, this specialist method requires specialist rods. These rods must indicate cautious bites but provide sufficient backbone when the fish has taken the bait. This rod ticks every box.



kompletný cenník na [www.SPORTS.sk](http://www.SPORTS.sk), výhradný distribútor pre SR: SPORTS s.r.o.





Code	Model	Length	Sections	C.W.	Tr.-Length	F.Tips	Weight
1293 180	Centex Felchen	1,80 m	2	1 - 9 g	0,94 m	2	80 g
1293 210	Centex Felchen	2,10 m	2	1 - 9 g	1,10 m	2	86 g
1293 240	Centex Felchen	2,40 m	2	1 - 9 g	1,24 m	2	90 g
1293 270	Centex Felchen	2,70 m	2	1 - 9 g	1,40 m	2	101 g

Code	Model	provided Feeder Tips
1293 180	Centex Felchen	Soft, Medium
1293 210	Centex Felchen	Soft, Medium
1293 240	Centex Felchen	Soft, Medium
1293 270	Centex Felchen	Soft, Medium

**CENTEX FELCHEN**

In the Centex Felchen, there is now a rod in the mid-price segment, which is optimally suited to coregone fishing. The light weight and comfort are sheer poetry. The thin, sensitive blank with two interchangeable tips in light and medium strengths is equipped with a specially designed eye for the lead weight on the rig, which can be safely attached when taking a break from fishing or when moving the fishing boat. The matching Centex reel can be found on page Q12/Q13



Now available in 1,80m.



Code	Model	Length	Sections	Tr.-Length	Weight
1525 090	L	0,90 m	1	light action	0,90 m 64 g
1526 090	M	0,90 m	1	medium action	0,90 m 59 g

**HYPERCAST FREEZER**

One-piece rod for ice-fishing. The extremely thin and sensitive blank makes winter angling a pleasure.







Code	Model	Length	Sections	C.W.	Tr.-Length	Weight
14805 300	Mr. Pike Standard Boat	3,00 m	2	250 g / 3,5 lb	1,56 m	305 g

**MR. PIKE STANDARD BOAT**  
 The typical trolling pike rod! Powerful backbone and parabolic action that guarantees trouble-free casting of your baitfish. The Mr. Pike 'Standard Boat' is far from standard. Unique in the pike rod segment with its trigger design, such special rods for use with multiplier reels are normally only available from rod manufacturers upon request. Thanks to its cushioning blank, the 3-metre rod bends steadily in the rod holder on a bite without offering the predator excessive resistance, guaranteeing that no fish are lost. Equipped with 10 twin-strut rings and a split cork/EVA handle. Additional extras: line clip.



Code	Model	Length	Sections	C.W.	Tr.-Length	Weight
14815 270	Mr. Pike Old School Zander	2,70 m	2	5 - 20 g	1,41 m	137 g
14815 300	Mr. Pike Old School Zander	3,00 m	2	5 - 20 g	1,56 m	152 g

**MR. PIKE OLD SCHOOL ZANDER**  
 A traditional deadbaiting rod range naturally includes a typical zander rod. In the Mr. Pike 'Old School Zander', we have developed a rod in true Dutch style in lengths of 2.7 m and 3 m. The blank is extremely sensitive, which is a huge advantage when legering to register the highly cautious bites. The rod also has a very special test curve, which guarantees risk-free casting of the deadbait while also easily cushioning the thrashing head movements of zander during a fight. Equipped with 6 and 7 rings and cork/EVA handles with integrated screw reel fittings. Extras: line clip r.



Code	Model	Length	Sections	C.W.	Tr.-Length	Weight
14800 360	Mr. Pike Classic Bank	3,60 m	2	200 g / 3,5 lbs	1,86 m	358 g

**MR. PIKE CLASSIC BANK**  
 As if made by 'hand': Classic, simple and to the point in terms of action - the Mr. Pike 'Classic Bank'! A typical English pike rod for all-round baitfish angling. Whether long-range legering with an inline or side-mounted lead or fishing tight to the bank with a finely balanced float rig, the 'Classic Bank' captivates with a perfect test curve in a fight, ensures that the baitfish lands trouble-free in the water (with no pull-outs) and impresses with sufficient power on the strike, even over long distances. The simple 3.6 m carbon-fibre blank is equipped with 5 long-cast, twin-strut rings and, thanks to the slender handle, sits perfectly in the hand or fits any buzzer bar. Extras: line clip.



Code	Model	Length	Sections	C.W.	Tr.-Length	Weight
14810 800	Mr. Pike Tele Bank	8,00 m	10	80 - 120 g	1,50 m	895 g

**MR. PIKE TELE BANK**  
 A typical deadbaiting rod for float fishing for pike, zander and eel - the Mr. Pike 'Tele Bank'. Despite its length of 8 metres, the rod has an extremely slender handle and sufficient action and backbone to offer predators a sizeable bait and set a successful strike. The 'Tele Bank' has a casting weight of 80 g to 120 g, while the simple matt black blank combined with the black rod rings ensures little light reflection or shadow on the water. When a deadbaiting rod is set down, it should loom as inconspicuously as possible above the weed, reeds and stone packing. Extras: reed holder, line clip and large hook keeper.

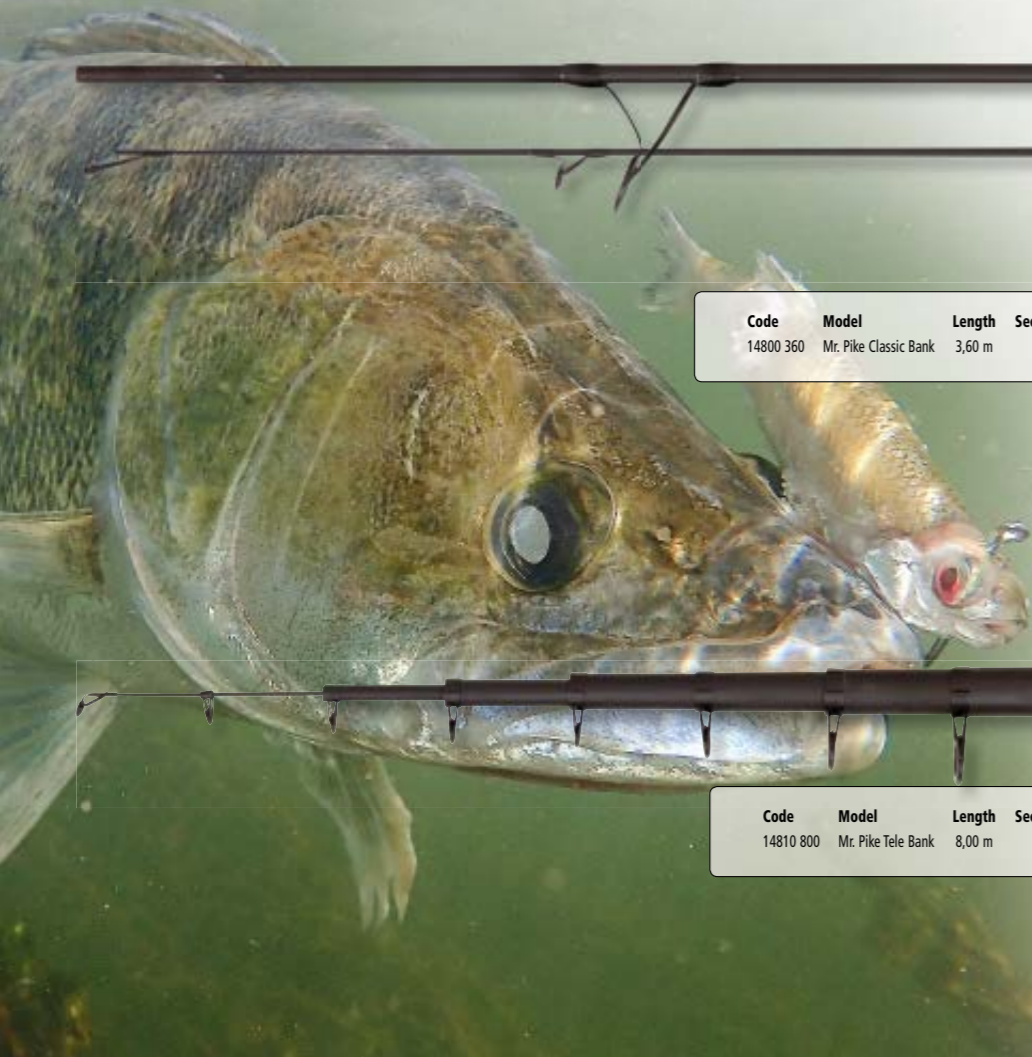





Code	Model	Length	Sections	C.W.	Tr.-Length	Weight
13804 420	World Champion Surf Masterpiece	4,20 m	3	100 - 250 g	1,45 m	495 g

**WORLD CHAMPION SURF MASTERPIECE**

By popular demand, the revolutionary masterpiece from Quantum will delight surf anglers. The powerful yet lightweight blank made from carbide carbon-fibre material possesses optimised 'loading up' properties, enabling world-class casting. The outstanding springiness provides optimal bite indication. This long-range casting superstar sits perfectly balanced in the hand thanks to the ergonomic handle. The robust, high-quality Fuji sliding reel holder also ensures a secure fit of the surf reel. What's more, the Fuji K Frame rings prevent the line from tangling around the blank during casting. The Hardshell rod holdall included ensures safe transport of this masterpiece.



Code	Model	Length	Sections	C.W.	Tr.-Length	Weight
13806 420	Maniac Duracast Surf	4,20 m	3	250 g	1,46 m	638 g
13806 450	Maniac Duracast Surf	4,50 m	3	250 g	1,56 m	708 g

**MANIAC DURACAST SURF**

A high-quality 3-piece, long-casting surf rod with a fast and powerful IM 6 carbon-fibre blank and proven K-Frame stainless steel rings ensures excellent casting performance. The Maniac Duracast Surf guarantees excellent casting properties. Even cautious bites are indicated reliably. Material reinforcements at the joints provide additional power. The rod's modern design is also highly attractive.







Code	Model	Length	Sections	C.W.	Tr.-Length	Weight
13805 420	HP 420	4,20 m	3	250 g	1,46 m	594 g
13805 450	HP 450	4,50 m	3	250 g	1,56 m	616 g

**IRON SURF**

During development of the Iron Surf, the engineers prioritised optimal loading up of the blank for long-range casting. The perfect combination of a powerful backbone and superlative bite indication. The high-quality steel rings, including a 50mm first ring, prevent the line from tangling around the blank during casting. Metallic reinforcements on the joints provide extra power. The ergonomic handle sits perfectly in the hand. The elegant design makes the rod an outstanding partner on the beach.



Code	Model	Length	Sections	C.W.	Tr.-Length	Weight
13807 390	Torrent Beach Fighter	3,90 m	3	200 g	1,36 m	364 g
13807 420	Torrent Beach Fighter	4,20 m	3	200 g	1,45 m	410 g
13807 450	Torrent Beach Fighter	4,50 m	3	200 g	1,56 m	480 g

**TORRENT BEACH FIGHTER**

The workhorse among the Quantum surf rods impresses with its comfortable handling and very good casting properties for all forms of surf angling. Casting weights of up to 200g can be catapulted into the surf with ease. The rod impresses with its majestic performance, allowing fish on the hook to be pumped to the bank with effortless ease.



kompletný cenník na [www.SPORTS.sk](http://www.SPORTS.sk), výhradný distribútor pre SR: SPORTS s.r.o.





Code	Model	Length	Sections	C.W.	Tr.-Length	Weight
13500 180	180 MSB	1,80 m	4	20 - 80 g	0,73 m	122 g
13500 210	210 MSB	2,10 m	4	20 - 80 g	0,75 m	135 g
13500 240	240 MSB	2,40 m	4	20 - 80 g	0,78 m	153 g
13500 270	270 MSB	2,70 m	4	20 - 80 g	0,85 m	170 g
13500 300	300 MSB	3,00 m	5	20 - 80 g	0,82 m	218 g

**TORRENT BUSCLE 80**  
 Value-for-money telescopic boat rod for feeder fishing in the sea with sensitive tip for precise bite indication. Sits incredibly comfortably in the hand and will be a valuable partner to anglers on the Mediterranean and elsewhere.



Code	Model	Length	Sections	C.W.	Tr.-Length	Weight
13501 250	250 HPX	2,50 m	4	10 - 110 g	0,79 m	175 g
13501 300	300 HPX	3,00 m	5	10 - 110 g	0,81 m	210 g
13501 350	350 HPX	3,50 m	5	10 - 110 g	0,94 m	230 g
13501 400	400 HPX	4,00 m	6	10 - 110 g	0,93 m	290 g

**IRON DORADA 110**  
 High-quality telescopic boat rod for feeder fishing in the sea with sensitive tip for precise bite indication. With its high-modulus carbon blank, the rod fulfils even the highest demands.



Code	Model	Length	Sections	C.W.	Tr.-Length	Weight
13808 420	Torrent Beach Fighter Tele	4,20 m	6	120 g	1,42 m	535 g
13808 421	Torrent Beach Fighter Tele	4,20 m	6	170 g	1,42 m	558 g

**TORRENT BEACH FIGHTER TELE**  
 The telescopic surf rod is almost perfect for all forms of surf angling, and all at an incredible price-performance ratio. The solid carbon-fibre design sits very light in the hand. The tip area is highly sensitive allowing the angler to detect even cautious bites reliably.



Code	Model	Length	Sections	C.W.	Tr.-Length	Weight
13809 420	Iron Tele Surf	4,20 m	6	120 g	1,42 m	483 g
13809 421	Iron Tele Surf	4,20 m	6	150 g	1,42 m	486 g

**IRON TELE SURF**  
 Lightweight telescopic rod for all-round use in the sea. With its high-quality carbide carbon-fibre blank, the slender Iron Tele Surf provides a powerful backbone combined with outstanding bite indication. The ideal partner for all surf anglers.



kompletný cenník na [www.SPORTS.sk](http://www.SPORTS.sk), výhradný distribútor pre SR: SPORTS s.r.o.





Code	Ø	Length	BS	Colour
2323 012	0,12 mm	300 m	1,50 kg / 3,40 lbs	transparent
2323 014	0,14 mm	300 m	2,10 kg / 4,40 lbs	transparent
2323 016	0,16 mm	300 m	2,60 kg / 5,60 lbs	transparent
2323 018	0,18 mm	300 m	3,10 kg / 6,80 lbs	transparent
2323 020	0,20 mm	300 m	3,80 kg / 8,40 lbs	transparent
2323 022	0,22 mm	300 m	4,70 kg / 10,50 lbs	transparent
2323 024	0,24 mm	300 m	5,90 kg / 13,00 lbs	transparent
2323 026	0,26 mm	300 m	6,90 kg / 15,30 lbs	transparent
2323 028	0,28 mm	300 m	8,10 kg / 17,80 lbs	transparent
2323 030	0,30 mm	300 m	9,00 kg / 19,80 lbs	transparent
2323 035	0,35 mm	300 m	11,00 kg / 24,30 lbs	transparent
2323 040	0,40 mm	300 m	15,20 kg / 33,50 lbs	transparent
2323 045	0,45 mm	300 m	17,20 kg / 37,90 lbs	transparent

Trade Pack 5 Pieces

**EXOFIL**

Exofil is a High Tech Monoline with a nano fluorocarbon surface coating, which creates an ultra smooth surface and ultimate high abrasion resistance. Highest quality Japanese Polyamid ensures maximum strength linear and knot strength as well. Inside of the line is a molecular compressed core compound copolymer which reduces the stretch. The low stretch of Exofil makes it perfectly suitable for modern spin fishing with soft and hard lures.



**EXOFIL**

Exofil is a High Tech Monoline with a nano fluorocarbon surface coating, which creates an ultra smooth surface and ultimate high abrasion resistance. Highest quality Japanese Polyamid ensures maximum strength linear and knot strength as well. Inside of the line is a molecular compressed core compound copolymer which reduces the stretch. The low stretch of Exofil makes it perfectly suitable for modern spin fishing with soft and hard lures.

Code	Ø	Length	BS	Colour
2323 316	0,16 mm	3000 m	2,6 kg / 5,6 lbs	transparent
2323 318	0,18 mm	3000 m	3,1 kg / 6,8 lbs	transparent
2323 320	0,20 mm	3000 m	3,8 kg / 8,4 lbs	transparent
2323 322	0,22 mm	3000 m	4,7 kg / 10,5 lbs	transparent
2323 324	0,24 mm	3000 m	5,9 kg / 13,0 lbs	transparent
2323 326	0,26 mm	3000 m	6,9 kg / 15,3 lbs	transparent
2323 328	0,28 mm	3000 m	8,1 kg / 17,8 lbs	transparent
2323 330	0,30 mm	3000 m	9,0 kg / 19,8 lbs	transparent
2323 335	0,35 mm	3000 m	11,0 kg / 24,3 lbs	transparent



**FLUORO-CARBON**

Code	Ø	Length	BS	Colour
2601 025	0,25 mm	50 m	4,66 kg / 10,3 lbs	transparent
2601 030	0,30 mm	50 m	6,03 kg / 13,3 lbs	transparent
2601 035	0,35 mm	50 m	8,04 kg / 17,7 lbs	transparent
2601 040	0,40 mm	50 m	10,42 kg / 23,0 lbs	transparent

Trade Pack 5 Pieces

**EXO FC**

Special leader material made of pure fluorocarbon for maximum breaking strain and abrasive resistance in particular. Thanks to its refraction index and new composition, the material is virtually invisible to the fish. Still it is easy to tie, and it is also suitable for crimping.



Supplied without line.

**LEADER DISPENSER BAG**

Special leader pocket with dispenser function. Not only is unwanted unwinding of expensive leader material in the bag a thing of the past, you can also pull off and cut the desired length as required. Space for five spools of leader material and compatible with our Quantum EXO FC spools or steel leader spools. Material: Polychlorid

Code	Ø	Width	Colour	Compartments
8517 043	10 cm	10 cm	black/red	5







**QUATTRON SALSA**

Transparent red line with outstanding qualities. The red coloration, which makes the line easy to identify and recognise above the water for the angler, disappears at a depth of 1.3m. The line is then invisible to fish. The Salsa is also highly resistant to friction and a true workhorse, especially for sea fishing and trolling. Available in economic 250g spools with high capacity.

Code	Ø	Length	BS	Colour
2611 118	0,18 mm	275 m	2,80 kg / 6,20 lbs	transparent red
2611 120	0,20 mm	275 m	3,50 kg / 7,70 lbs	transparent red
2611 122	0,22 mm	275 m	4,50 kg / 9,90 lbs	transparent red
2611 125	0,25 mm	275 m	5,70 kg / 12,50 lbs	transparent red
2611 130	0,30 mm	275 m	7,70 kg / 17,00 lbs	transparent red
2611 135	0,35 mm	275 m	10,50 kg / 23,10 lbs	transparent red
2611 140	0,40 mm	275 m	12,50 kg / 27,60 lbs	transparent red

Trade Pack 10 Pieces



**QUATTRON SALSA**

Transparent red line with outstanding qualities. The red coloration, which makes the line easy to identify and recognise above the water for the angler, disappears at a depth of 1.3m. The line is then invisible to fish. The Salsa is also highly resistant to friction and a true workhorse, especially for sea fishing and trolling. Available in economic 250g spools with high capacity.

Code	Ø	Length	BS	Colour
2611 018	0,18 mm	3000 m	2,80 kg / 6,20 lbs	transparent red
2611 020	0,20 mm	3000 m	3,50 kg / 7,70 lbs	transparent red
2611 022	0,22 mm	3000 m	4,50 kg / 9,90 lbs	transparent red
2611 025	0,25 mm	3000 m	5,70 kg / 12,50 lbs	transparent red
2611 030	0,30 mm	2901 m	7,70 kg / 17,00 lbs	transparent red
2611 035	0,35 mm	2131 m	10,50 kg / 23,10 lbs	transparent red
2611 040	0,40 mm	1632 m	12,50 kg / 27,60 lbs	transparent red
2611 045	0,45 mm	1289 m	16,50 kg / 36,40 lbs	transparent red



**QUATTRON PT**

Quattron has been a firm favourite with anglers for years. Many thousands trust this monofilament which enjoys an unquestioned place at the top of the line market. Incredibly, our product developers have even managed to improve the formula yet again to produce an even more capable Quattron. The Quattron PT (PT = Performance Tuned) is the ultimate monofilament, without rival in terms of strength, wear resistance, knot strength, durability and so on. You can rely implicitly on Quattron PT. Countless tests testify to that fact. The line has received the EFTTA (European Fishing Tackle Manufacturer Association) seal of approval, which confirms the correctness of the stated performance parameters. Test it for yourself and be amazed.

Code	Ø	Length	BS	Colour
2301 015	0,15 mm	150 m	2,10 kg / 4,60 lbs	transparent
2301 017	0,17 mm	150 m	2,60 kg / 5,70 lbs	transparent
2301 018	0,18 mm	150 m	3,10 kg / 6,80 lbs	transparent
2301 020	0,20 mm	150 m	3,85 kg / 8,40 lbs	transparent
2301 023	0,23 mm	150 m	5,10 kg / 11,20 lbs	transparent
2301 026	0,26 mm	150 m	6,30 kg / 13,80 lbs	transparent
2301 028	0,29 mm	150 m	7,40 kg / 16,30 lbs	transparent
2301 030	0,31 mm	150 m	8,50 kg / 18,70 lbs	transparent
2301 033	0,33 mm	150 m	9,50 kg / 21,00 lbs	transparent
2301 037	0,37 mm	150 m	11,60 kg / 25,00 lbs	transparent

Trade Pack 10 Pieces



**QUATTRON PT**

The Quattron PT (PT = Performance Tuned) is the ultimate monofilament, without rival in terms of strength, wear resistance, knot strength, durability and so on. You can rely implicitly on Quattron PT.

Code	Ø	Length	BS	Colour
2301 318	0,18 mm	3000 m	3,10 kg / 6,80 lbs	transparent
2301 320	0,20 mm	3000 m	3,85 kg / 8,40 lbs	transparent
2301 323	0,23 mm	3000 m	5,10 kg / 11,20 lbs	transparent
2301 326	0,26 mm	3000 m	6,30 kg / 13,80 lbs	transparent
2301 328	0,29 mm	3000 m	7,40 kg / 16,30 lbs	transparent
2301 330	0,31 mm	3000 m	8,50 kg / 18,70 lbs	transparent
2301 333	0,33 mm	3000 m	9,50 kg / 21,00 lbs	transparent







**ULTREX SUPER 8 BRAID**

This line is not just any braid. Ultrex stands for ultra performance. Better performance than even spoiled spinning and sea anglers could dream of. The 8-strand braid produces an incredibly round line that moves extremely softly through the rod rings on casting and retrieval. The elasticity has been reduced to a minimum ensuring the angler always has optimal contact with his bait or opponent, while the sensational strength of the Ultrex makes it an unassailable adversary for any scaled specimen.

Code	Ø	Length	BS	Colour
2309 012	0,12 mm	110 m	6,80 kg / 15 lbs	red
2309 014	0,14 mm	110 m	9,10 kg / 20 lbs	red
2309 017	0,17 mm	110 m	10,00 kg / 22 lbs	red
2309 020	0,20 mm	110 m	11,00 kg / 25 lbs	red
2309 025	0,25 mm	110 m	15,00 kg / 34 lbs	red
2309 030	0,30 mm	110 m	20,00 kg / 45 lbs	red



**ULTREX SUPER 8 BRAID**

This line is not just any braid. Ultrex stands for ultra performance. Better performance than even spoiled spinning and sea anglers could dream of. The 8-strand braid produces an incredibly round line that moves extremely softly through the rod rings on casting and retrieval. The elasticity has been reduced to a minimum ensuring the angler always has optimal contact with his bait or opponent, while the sensational strength of the Ultrex makes it an unassailable adversary for any scaled specimen.

Code	Ø	Length	BS	Colour
2321 012	0,12 mm	110 m	6,80 kg / 15 lbs	green
2321 014	0,14 mm	110 m	9,10 kg / 20 lbs	green
2321 017	0,17 mm	110 m	10,00 kg / 22 lbs	green
2321 020	0,20 mm	110 m	11,00 kg / 25 lbs	green
2321 025	0,25 mm	110 m	15,00 kg / 34 lbs	green
2321 030	0,30 mm	110 m	20,00 kg / 45 lbs	green



**ULTREX SUPER 8 BRAID**

This line is not just any braid. Ultrex stands for ultra performance. Better performance than even spoiled spinning and sea anglers could dream of. The 8-strand braid produces an incredibly round line that moves extremely softly through the rod rings on casting and retrieval. The elasticity has been reduced to a minimum ensuring the angler always has optimal contact with his bait or opponent, while the sensational strength of the Ultrex makes it an unassailable adversary for any scaled specimen.

Code	Ø	Length	BS
2309 112	0,12 mm	1000 m	6,80 kg / 15 lbs
2309 114	0,14 mm	1000 m	9,10 kg / 20 lbs
2309 117	0,17 mm	1000 m	10,00 kg / 22 lbs
2309 120	0,20 mm	1000 m	11,00 kg / 25 lbs
2309 125	0,25 mm	1000 m	15,00 kg / 34 lbs
2309 130	0,30 mm	1000 m	20,00 kg / 45 lbs



**ULTREX SUPER 8 BRAID**

This line is not just any braid. Ultrex stands for ultra performance. Better performance than even spoiled spinning and sea anglers could dream of. The 8-strand braid produces an incredibly round line that moves extremely softly through the rod rings on casting and retrieval. The elasticity has been reduced to a minimum ensuring the angler always has optimal contact with his bait or opponent, while the sensational strength of the Ultrex makes it an unassailable adversary for any scaled specimen.

Code	Ø	Length	BS	Colour
2321 112	0,12 mm	1000 m	6,80 kg / 15 lbs	green
2321 114	0,14 mm	1000 m	9,10 kg / 20 lbs	green
2321 117	0,17 mm	1000 m	10,00 kg / 22 lbs	green
2321 120	0,20 mm	1000 m	11,00 kg / 25 lbs	green
2321 125	0,25 mm	1000 m	15,00 kg / 34 lbs	green
2321 130	0,30 mm	1000 m	20,00 kg / 45 lbs	green





NEW



SMART XTR BRAID

Quantum Smart XTR Braid is a braided line with an innovative coating that hardly increases the line's diameter. The process conserves the thin diameter of the base material, allowing the angler to enjoy the line's softness fully when fishing. Distant casts can be performed easily. The blue color is specially designed to be virtually invisible to the fish against the sky. This makes the Quantum Smart XTR Braid a great choice for general spin fishing and for targeting wary fish in clear water, in particular.

Code	Ø	Length	BS	Colour
2336 010	0,10 mm	130 m	3,6 kg / 8 lbs	blue
2336 012	0,12 mm	130 m	4,5 kg / 10 lbs	blue
2336 014	0,14 mm	130 m	6,8 kg / 15 lbs	blue
2336 017	0,17 mm	130 m	9,1 kg / 20 lbs	blue
2336 020	0,20 mm	130 m	11,5 kg / 25 lbs	blue

Trade Pack 5 Pieces



NEW

SMART XTR BRAID

Quantum Smart XTR Braid is a braided line with an innovative coating that hardly increases the line's diameter. The process conserves the thin diameter of the base material, allowing the angler to enjoy the line's softness fully when fishing. Distant casts can be performed easily. The blue color is specially designed to be virtually invisible to the fish against the sky. This makes the Quantum Smart XTR Braid a great choice for general spin fishing and for targeting wary fish in clear water, in particular.

Code	Ø	Length	BS	Colour
2336 110	0,10 mm	1000 m	3,6 kg / 8 lbs	blue
2336 112	0,12 mm	1000 m	4,5 kg / 10 lbs	blue
2336 114	0,14 mm	1000 m	6,8 kg / 15 lbs	blue
2336 117	0,17 mm	1000 m	9,1 kg / 20 lbs	blue
2336 120	0,20 mm	1000 m	11,5 kg / 25 lbs	blue



Code	Ø	Length	BS	Colour
2613 050	0,50 mm	50 m	15,90 kg / 35,10 lbs	transparent
2613 060	0,60 mm	50 m	22,20 kg / 48,90 lbs	transparent
2613 070	0,70 mm	50 m	29,70 kg / 65,50 lbs	transparent
2613 080	0,80 mm	50 m	40,00 kg / 88,20 lbs	transparent
2613 090	0,90 mm	50 m	50,00 kg / 110,20 lbs	transparent

Trade Pack 10 Pieces

QUATTRON MONO LEADER

The newly developed material is of a rigidity designed to make excellent knots while also providing the necessary elasticity and durability. The large diameter spool guarantees curl-free material and safe transport.

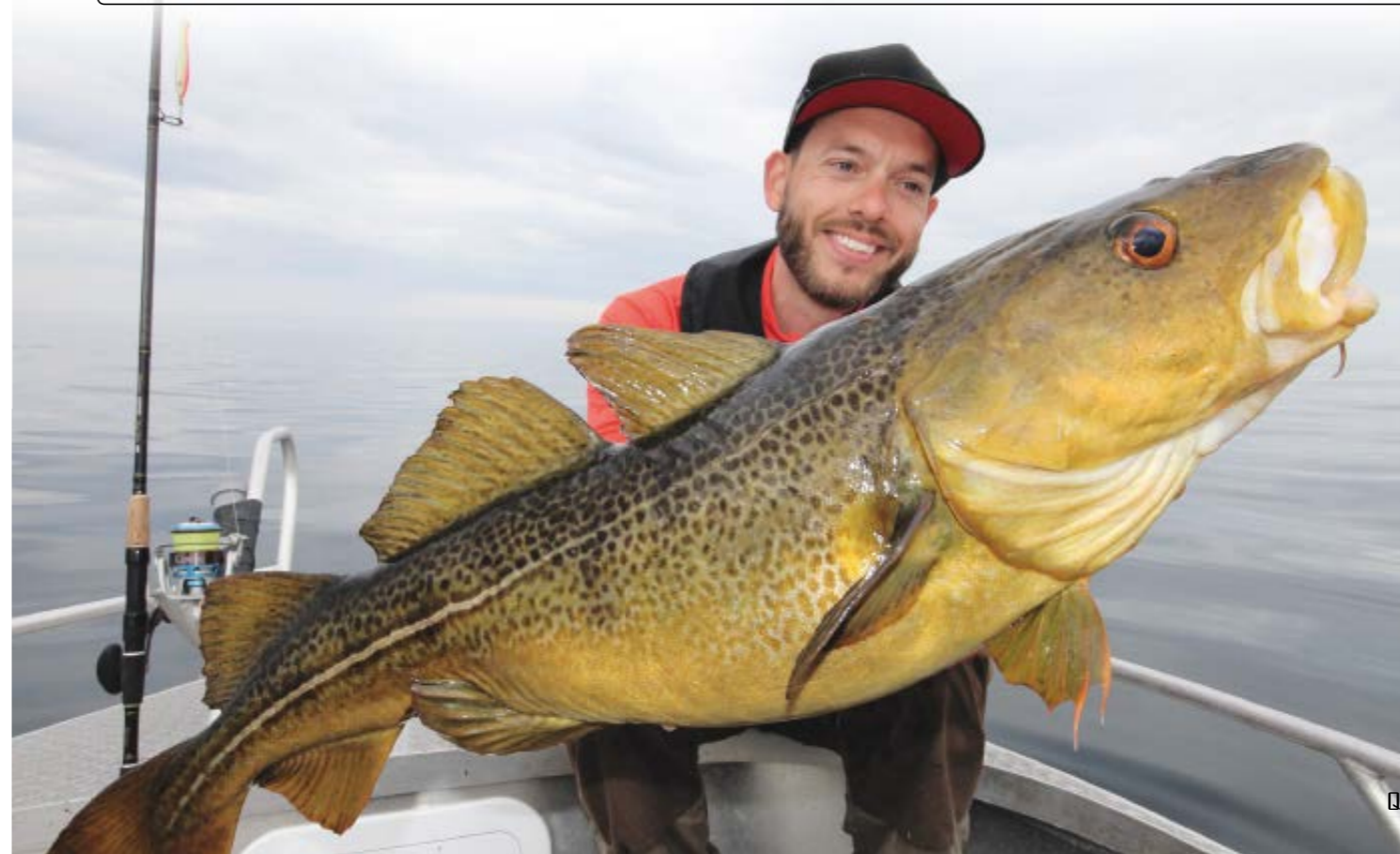





**CRANK GIPSY FD F**

New Crankbait from Quantum. The Crank Gipsy is available in three carefully selected sizes, extending its range of uses from chub and trout to black bass and pike. Eight attractive designs ensure optimal visibility of the lure in any water coloration, any weather and at all times of day. Supplied with ultra-sharp treble hook as well as a single hook with a large eye, giving the angler the option of switching to a single-hook rig. The Crank Gipsy is a floating wobbler, available in two different depths. FD F = Flat Diver Floating and DD F = Deep Diver Floating

Length	Weight	Content	Diving Depth	Action	perch	snow	tuna	goldfish	ayu	peacock	koi	sardine
26 mm	3 g	1 pcs	-0,3 m	floating	3253 001	3253 002	3253 003	3253 004	3253 005	3253 006	3253 007	3253 008
36 mm	5 g	1 pcs	-0,4 m	floating	3253 101	3253 102	3253 103	3253 104	3253 105	3253 106	3253 107	3253 108
52 mm	14 g	1 pcs	-0,5 m	floating	3253 201	3253 202	3253 203	3253 204	3253 205	3253 206	3253 207	3253 208

Trade Pack 5 Pieces



**MINNOW GIPSY FD SU**

New Minnow Wobbler from Quantum. The Minnow Gipsy is available in three sizes, each with three different depths, covering a huge range of modern angling techniques. From fishing on very light tackle in streams for orfe to deep trolling for zander, this series covers it all. Eight attractive designs ensure optimal visibility of the lure in any water colouration, any weather and at all times of day. Supplied with two ultra-sharp treble hooks as well as two single hooks with a large eye, giving the angler the option of switching to a single-hook rig. Equipped with balls for directional stability, the wobbler flies straight and far without rotating on the cast. The Minnow Gipsy is a floating wobbler, available in three different depths. FD SU = Flat Diver SUSpending D SU = Diver SUSpending DD SU = Deep Diver SUSpending

Length	Weight	Content	Diving Depth	Action	perch	snow	tuna	goldfish	ayu	peacock	koi	sardine
49 mm	4 g	1 pcs	-0,3 m	suspender	3255 001	3255 002	3255 003	3255 004	3255 005	3255 006	3255 007	3255 008
62 mm	6 g	1 pcs	-0,5 m	suspender	3255 101	3255 102	3255 103	3255 104	3255 105	3255 106	3255 107	3255 108
108 mm	20 g	1 pcs	-0,6 m	suspender	3255 201	3255 202	3255 203	3255 204	3255 205	3255 206	3255 207	3255 208

Trade Pack 5 Pieces



**CRANK GIPSY DD F**

New Crankbait from Quantum. The Crank Gipsy is available in three carefully selected sizes, extending its range of uses from chub and trout to black bass and pike. Eight attractive designs ensure optimal visibility of the lure in any water coloration, any weather and at all times of day. Supplied with ultra-sharp treble hook as well as a single hook with a large eye, giving the angler the option of switching to a single-hook rig. The Crank Gipsy is a floating wobbler, available in two different depths. FD F = Flat Diver Floating and DD F = Deep Diver Floating

Length	Weight	Content	Diving Depth	Action	snow	tuna	goldfish	ayu	peacock	koi	sardine	perch
26 mm	3 g	1 pcs	-0,7 m	floating	3254 002	3254 003	3254 004	3254 005	3254 006	3254 007	3254 008	
36 mm	6 g	1 pcs	-1 m	floating	3254 102	3254 103	3254 104	3254 105	3254 106	3254 107	3254 108	3254 101
52 mm	15 g	1 pcs	-2,5 m	floating	3254 202	3254 203	3254 204	3254 205	3254 206	3254 207	3254 208	3254 201

Trade Pack 5 Pieces



**MINNOW GIPSY D SU**

New Minnow Wobbler from Quantum. The Minnow Gipsy is available in three sizes, each with three different depths, covering a huge range of modern angling techniques. From fishing on very light tackle in streams for orfe to deep trolling for zander, this series covers it all. Eight attractive designs ensure optimal visibility of the lure in any water colouration, any weather and at all times of day. Supplied with two ultra-sharp treble hooks as well as two single hooks with a large eye, giving the angler the option of switching to a single-hook rig. Equipped with balls for directional stability, the wobbler flies straight and far without rotating on the cast. The Minnow Gipsy is a floating wobbler, available in three different depths. FD SU = Flat Diver SUSpending D SU = Diver SUSpending DD SU = Deep Diver SUSpending

Length	Weight	Content	Diving Depth	Action	perch	snow	tuna	goldfish	ayu	peacock	koi	sardine
49 mm	4 g	1 pcs	-0,5 m	suspender	3256 001	3256 002	3256 003	3256 004	3256 005	3256 006	3256 007	3256 008
62 mm	5 g	1 pcs	-0,8 m	suspender	3256 101	3256 102	3256 103	3256 104	3256 105	3256 106	3256 107	3256 108
108 mm	17 g	1 pcs	-1,5 m	suspender	3256 201	3256 202	3256 203	3256 204	3256 205	3256 206	3256 207	3256 208

Trade Pack 5 Pieces





**MINNOW GIPSY DD SU**

New Minnow Wobbler from Quantum. The Minnow Gipsy is available in three sizes, each with three different depths, covering a huge range of modern angling techniques. From fishing on very light tackle in streams for orfe to deep trolling for zander, this series covers it all. Eight attractive designs ensure optimal visibility of the lure in any water colouration, any weather and at all times of day. Supplied with two ultra-sharp treble hooks as well as two single hooks with a large eye, giving the angler the option of switching to a single-hook rig. Equipped with balls for directional stability, the wobbler flies straight and far without rotating on the cast. The Minnow Gipsy is a floating wobbler, available in three different depths. FD SU = Flat Diver SUSpending D SU = Diver SUSpending DD SU = Deep Diver SUSpending

Length	Weight	Content	Diving Depth	Action	perch	snow	tuna	goldfish	ayu	peacock	koi	sardine
49 mm	4 g	1 pcs	- 0,8 m	suspender	3257 001	3257 002	3257 003	3257 004	3257 005	3257 006	3257 007	3257 008
62 mm	5 g	1 pcs	- 1,2 m	suspender	3257 101	3257 102	3257 103	3257 104	3257 105	3257 106	3257 107	3257 108
108 mm	18 g	1 pcs	- 5 m	suspender	3257 201	3257 202	3257 203	3257 204	3257 205	3257 206	3257 207	3257 208

Trade Pack 5 Pieces

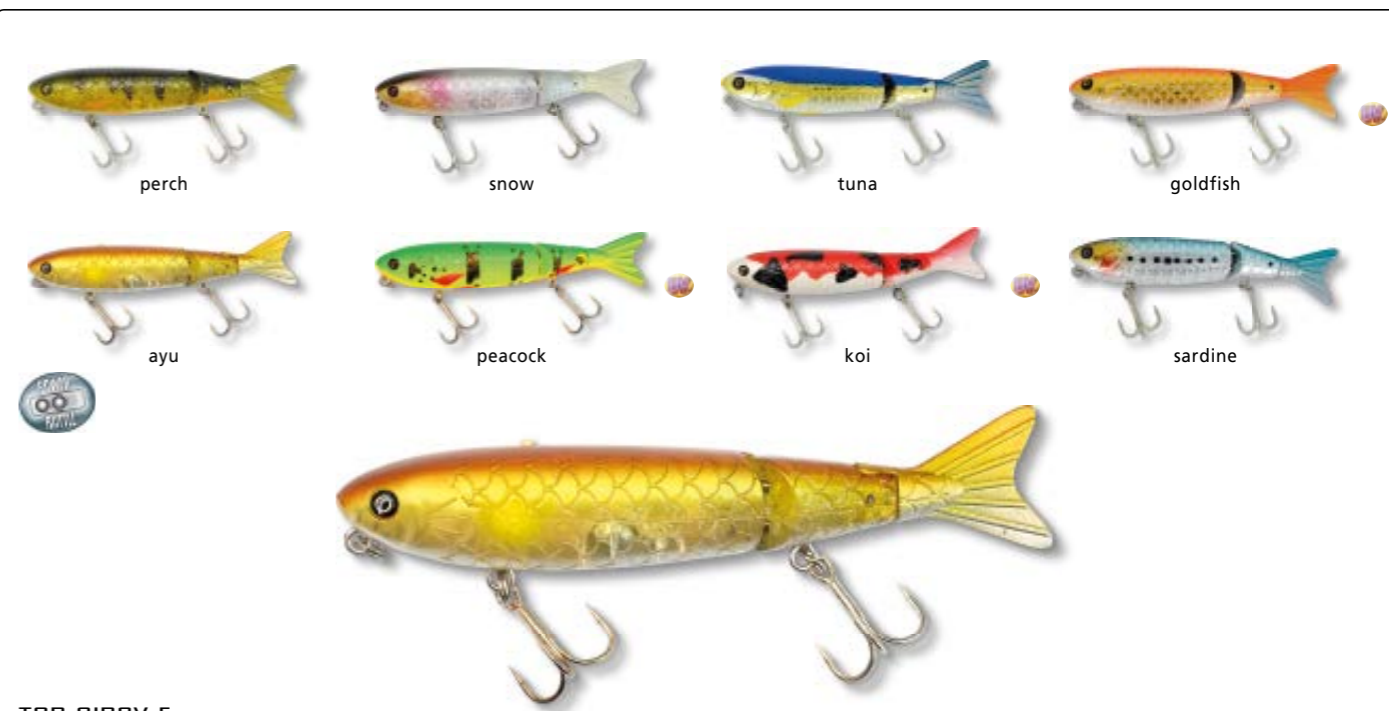

**TOP GIPSY F**

New two-piece stickbait with two interchangeable tails in soft plastic in colours to match the design. The Top Gipsy dances to light twitches of the rod in a walk-the-dog action across the surface of the water, driving predators wild. The 7.5 cm and 10 cm sizes cover perch, asp and pike sport perfectly. Eight attractive designs ensure optimal visibility of the lure in any water colouration, any weather and at all times of day. Supplied with two ultra-sharp treble hooks as well as two single hooks with a large eye, giving the angler the option of switching to a single-hook rig.

Length	Weight	Content	Diving Depth	Action	perch	snow	tuna	goldfish	ayu	peacock	koi	sardine
75 mm	5 g	3 items	- 0 m	floating	3260 201	3260 202	3260 203	3260 204	3260 205	3260 206	3260 207	3260 208
100 mm	12 g	3 items	- 0 m	floating	3260 301	3260 302	3260 303	3260 304	3260 305	3260 306	3260 307	3260 308

Trade Pack 5 Pieces

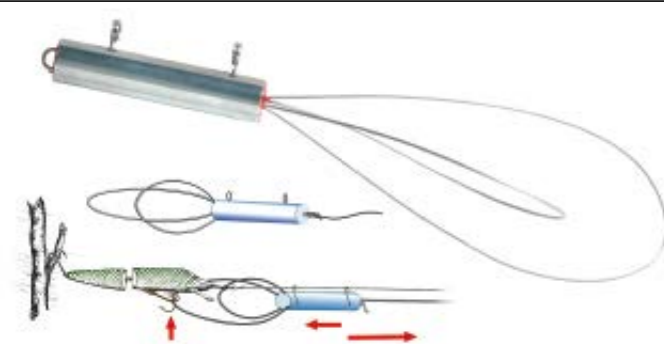

**LURE RETRIEVER. SMALL**

Another design from Peter Biedron is this Plug Rescuer. This plug will glide behind a stiff, powerful line in case of snags. One of the two soft, stainless steel loops will wrap around the plug, allowing the whole unit to be retrieved.

Code	Ø	Weight	Content
6501 001	3,0 mm	150 g	1 pcs
6501 002	12 mm	260 g	1 pcs

Trade Pack 5 Pieces

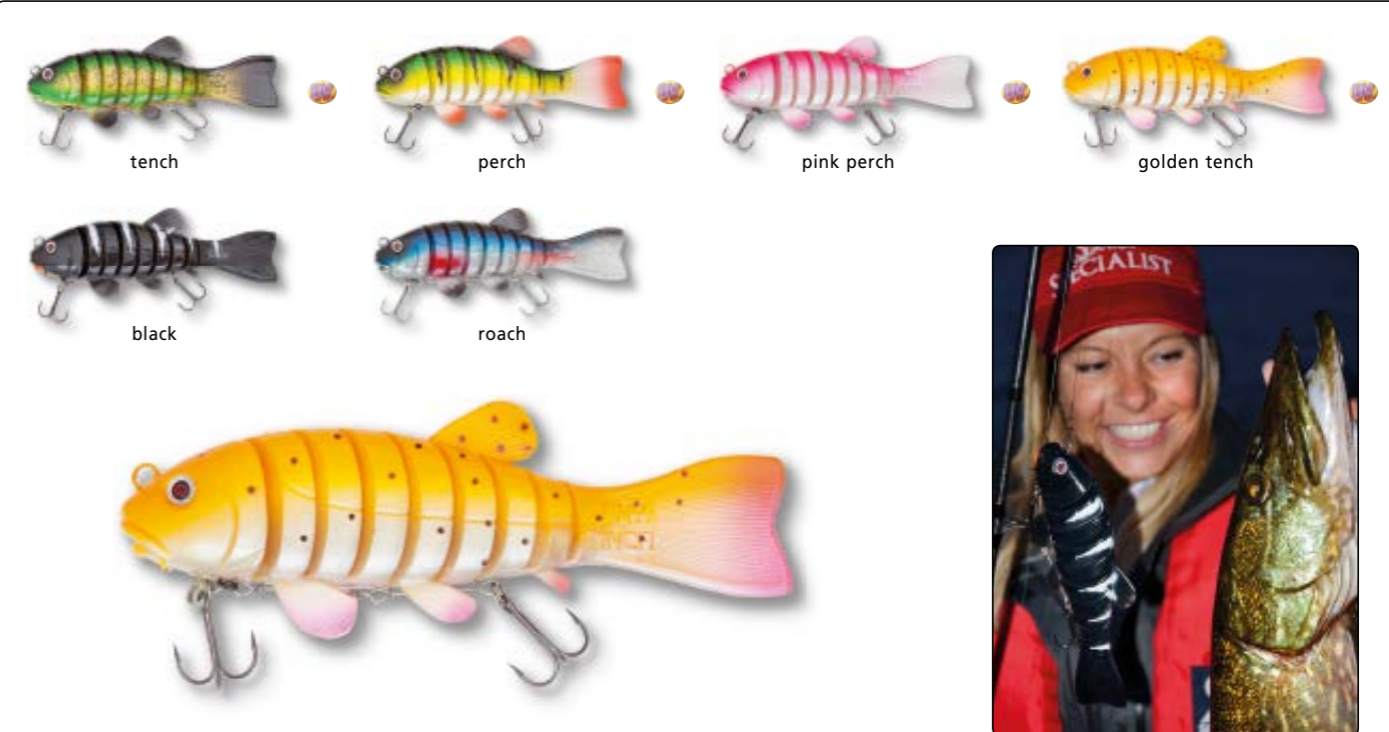
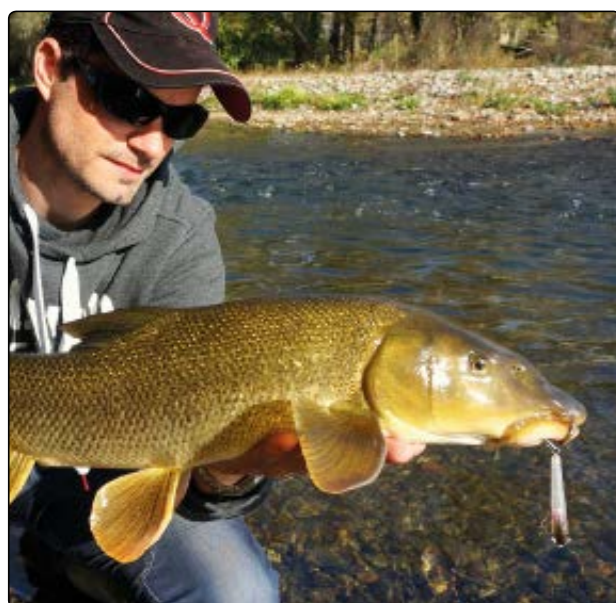

**TINY TINCA**

The new Tini Tinca is a lure specially developed for those difficult to fish waters. V-shaped limbs give the lure a natural action even with a slow retrieval. Six designs from "realistic" to "trendy" and two sizes cover a range of target species from perch to pike. Ultra-sharp Original MUSTAD hooks (2 on big size, 1 on small size) ensure an optimal and more importantly long-lasting hooking effect.

Length	Weight	Action	tench	perch	pink perch	golden tench	black	roach
12 cm	24 g	sinking	3269 101	3269 102	3269 103	3269 104	3269 106	
19,5 cm	110 g	sinking	3269 301	3269 302	3269 303	3269 304	3269 306	3269 305

Trade Pack 5 Pieces

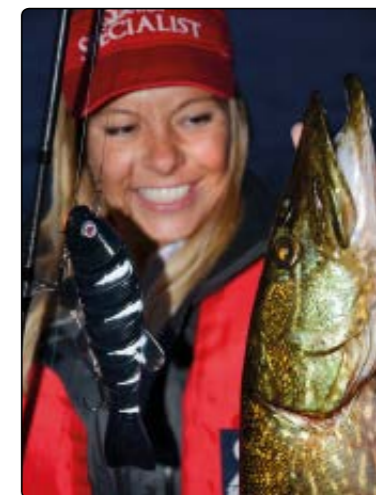



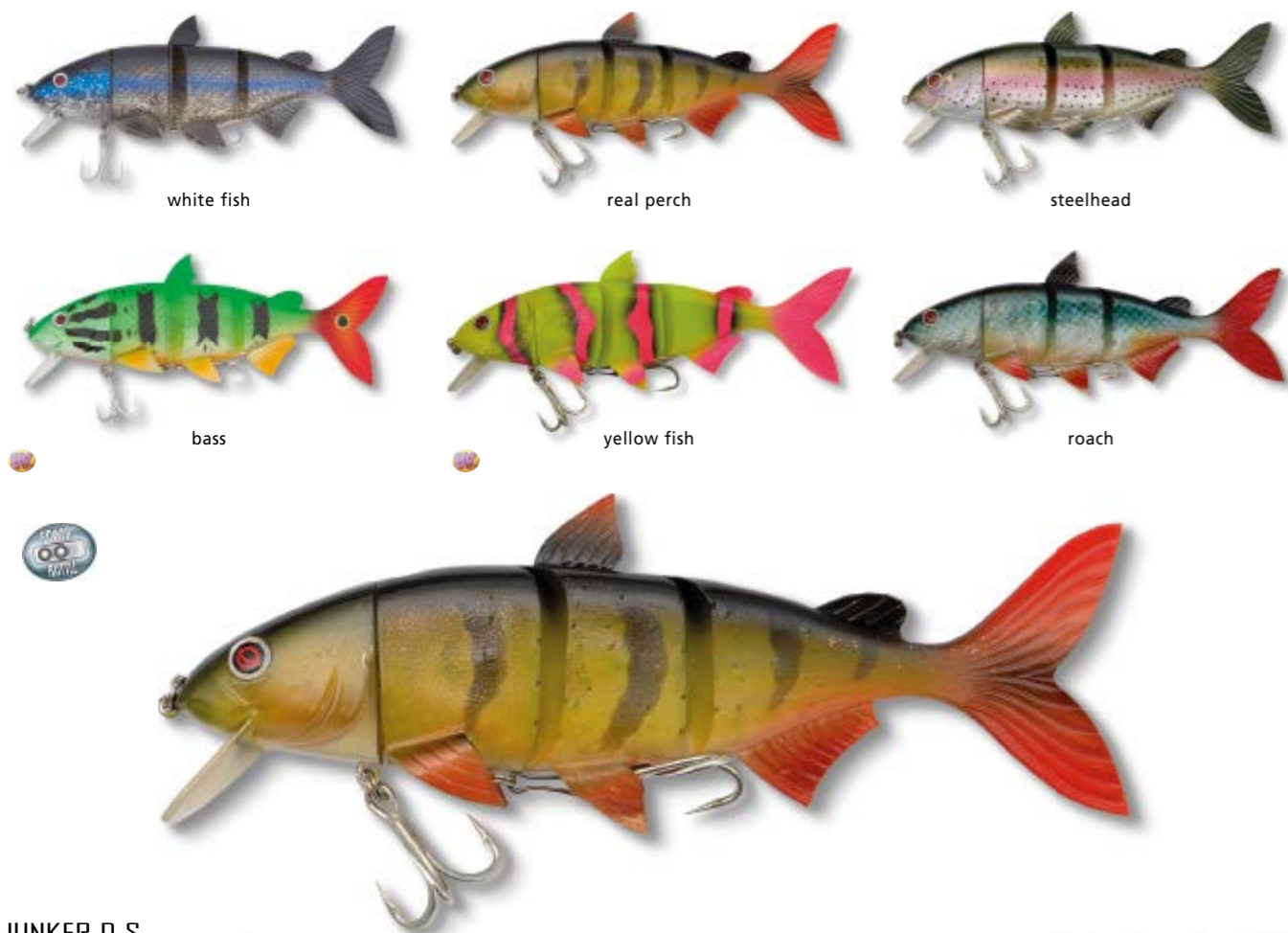

**JUNKER D S**

The Junker is a new realbait in a whitefish design. With a completely natural action and five designs from natural to bright colours, the lure is a true weapon for pike and zander. Both the 18 and 24 cm sizes are perfectly suited to casting as well as trolling from a boat. Fitted with an ultra-sharp treble hook plus a double hook that holds to the body with a magnet but can come away during a fight to prevent the fish from shaking out the lure.

Length	Weight	Content	Diving Depth	Action	white fish	real perch	steelhead	bass	yellow fish	roach
180 mm	57 g	3 items	- 1,5 m	slow sinking	3225 101	3225 102	3225 103	3225 104	3225 105	3225 106
240 mm	120 g	3 items	- 2 m	slow sinking	3225 201	3225 202	3225 203	3225 204	3225 205	3225 206

Trade Pack 5 Pieces



**FAT GIPSY FD F**

The Fat Gipsy is an ultra-robust wobbler equipped with a stainless steel axis all the way through and extra-strong trebles. These features make the lure a robust catching machine that can contend with pike etc., and even catfish without being heavy or cumbersome for the angler. Two depths cover the most important water depths. Eight attractive designs ensure optimal visibility of the lure in any water colouration, any weather and at all times of day. FD F = Flat Diver Floating and DD F = Deep Diver Floating

Length	Weight	Content	Diving Depth	Action	perch	snow	tuna	goldfish	ayu	peacock	koi	sardine
130 mm	45 g	1 pcs	- 1 m	floating	3258 301	3258 302	3258 303	3258 304	3258 305	3258 306	3258 307	3258 308

Trade Pack 5 Pieces



**FAT GIPSY DD F**

The Fat Gipsy is an ultra-robust wobbler equipped with a stainless steel axis all the way through and extra-strong trebles. These features make the lure a robust catching machine that can contend with pike etc., and even catfish without being heavy or cumbersome for the angler. Two depths cover the most important water depths. Eight attractive designs ensure optimal visibility of the lure in any water colouration, any weather and at all times of day. FD F = Flat Diver Floating and DD F = Deep Diver Floating

Length	Weight	Content	Diving Depth	Action	perch	snow	tuna	goldfish	ayu	peacock	koi	sardine
130 mm	48 g	1 pcs	- 5 m	floating	3259 301	3259 302	3259 303	3259 304	3259 305	3259 306	3259 307	3259 308

Trade Pack 5 Pieces



kompletný cenník na [www.SPORTS.sk](http://www.SPORTS.sk), výhradný distribútor pre SR: SPORTS s.r.o.



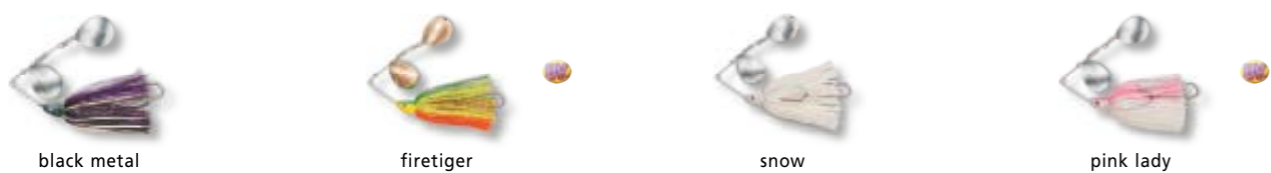

**SPINNER BAIT PIKE**

Pike love to hide in weed or water lilies, particularly in summer. The Pike Spinnerbait has been developed to lure the predators out of this tricky terrain. Two large, rotating spinner blades attract their attention while the double hook ensures a firm hold even on cautious takes.

Length	Weight	Content	Action	black metal	firetiger	snow	pink lady	bloody offspring
20 cm	65 g	1 pcs	sinking	3000 701	3000 702	3000 703	3000 704	3000 705

Trade Pack 5 Pieces



**SKIRTED JIG HEAD**

New Skirted Jig Head in five attractive designs, with weed protection and an ultra-sharp hook. Available in three different weights, the lure covers fishing at all of the most important water depths.

Weight	Content	Hook Size	fluo yellow	white/orange	sand black	brown	black/red
10 g	1 pcs	4/0	3140 101	3140 102	3140 103	3140 104	3140 105
14 g	1 pcs	4/0	3140 201	3140 202	3140 203	3140 204	3140 205
18 g	1 pcs	4/0	3140 301	3140 302	3140 303	3140 304	3140 305

Trade Pack 5 Pieces



**SPINNER BAIT**

Length	Weight	black metal	firetiger	snow	pink lady	bloody offspring
7 cm	8 g	3000 001	3000 002	3000 003	3000 004	3000 005
7 cm	12 g	3000 101	3000 102	3000 103	3000 104	3000 105
7 cm	16 g	3000 201	3000 202	3000 203	3000 204	3000 205
10 cm	10 g		3000 302	3000 303		3000 305
10 cm	15 g	3000 401	3000 402	3000 403	3000 404	3000 405
10 cm	20 g	3000 501	3000 502	3000 503	3000 504	3000 505

Trade Pack 5 Pieces

Spin-bait in two sizes and three weights, specially tailored for European fishing. The smaller size with one spinner blade has been specially developed for perch angling and proved hugely successful for the testers – particularly on difficult waters to fish and for those hard-to-catch prickly predators. The larger spin-bait is equipped with two spinner blades and appeals more to the pike in our waters with its strong pressure waves and shocking colours.







**SPOOKY JERK**

What an extraordinary jerkbait! The perfect retrieve action and phenomenal designs make the spooky jerk unique and frighteningly effective. All colours are ghostly UV-active and stir up predators' blood! Even beginners can use this lure effortlessly and enjoy success. Both the floating and slow-sinking models are must-haves in every lure box. Let the spooking commence!

Length	Weight	Action	andromeda	arapaima	black wave	disco	firetiger	grave digger	green poison	kingfisher	pike perch	tropical
16 cm	88 g	suspender	3311 001	3311 002	3311 003	3311 004	3311 005	3311 006	3311 007	3311 008	3311 009	3311 010
16 cm	92 g	slow sinking		3311 102	3311 103	3311 104	3311 105	3311 106	3311 107	3311 108	3311 109	3311 110

Trade Pack 5 Pieces



**DROPSHOT SET L**

Contents: • 2x Offset Hook #4/0 • Dropshot Lead 10g/14g • 2x 1m Fluro Carbon 0.25mm • 2x Rolling Swivel #10 • 3x Freddie Shad 12cm

Code  
3201 100  
Trade Pack 5 Pieces



**PERCH SET**

Contents: • 2x Round Jig Head 5g #1 • 2x Round Jig Head 7.5g #1 • 2x Ari's Pin 7.5cm • 2x Dangler 5cm • 2x Digger 6cm

Code  
3201 103  
Trade Pack 5 Pieces



**DROPSHOT SET XL**

Contents: • 2x Offset Hook #5/0 • Dropshot Lead 14g/18g • 2x 1m Fluro Carbon 0.30mm • 2x Rolling Swivel #8 • 3x Freddie Shad 15cm

Code  
3201 101  
Trade Pack 5 Pieces



**TEXAS / CAROLINA RIG SET**

Contents: • 2x Offset Wormhook #3/0 • Bullet Weight 10g/14g • 2x 1m Fluro Carbon 0.30mm • 2x Swivel #8 • Glas Bead 1x red, 1x transparent • 4x Dude Worm 16cm

Code  
3201 102  
Trade Pack 5 Pieces

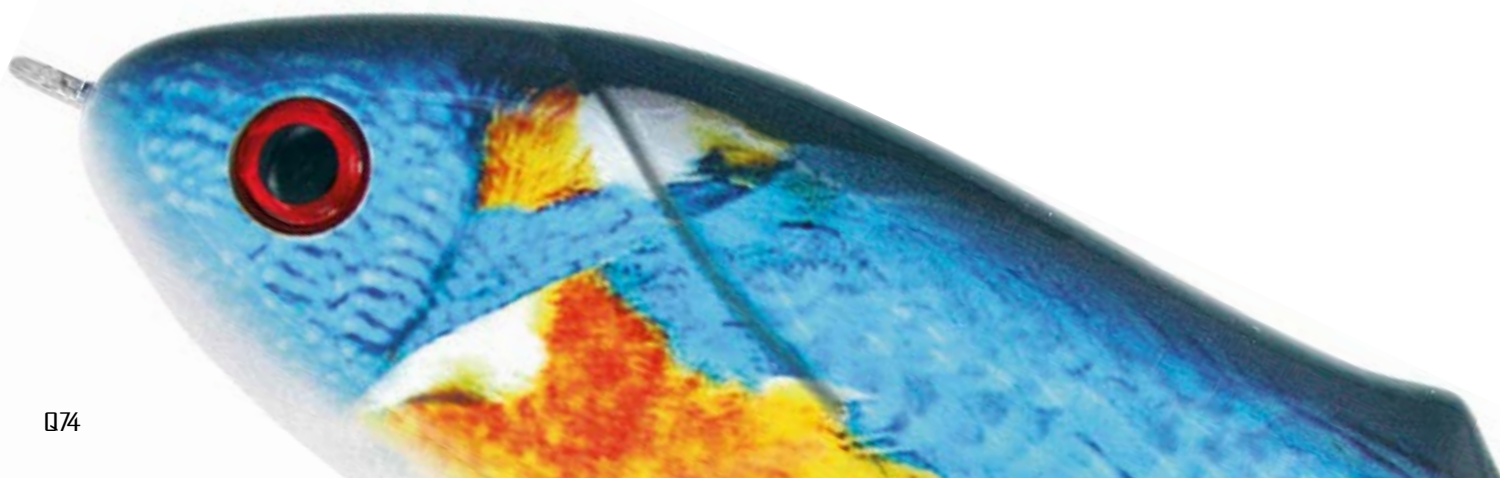



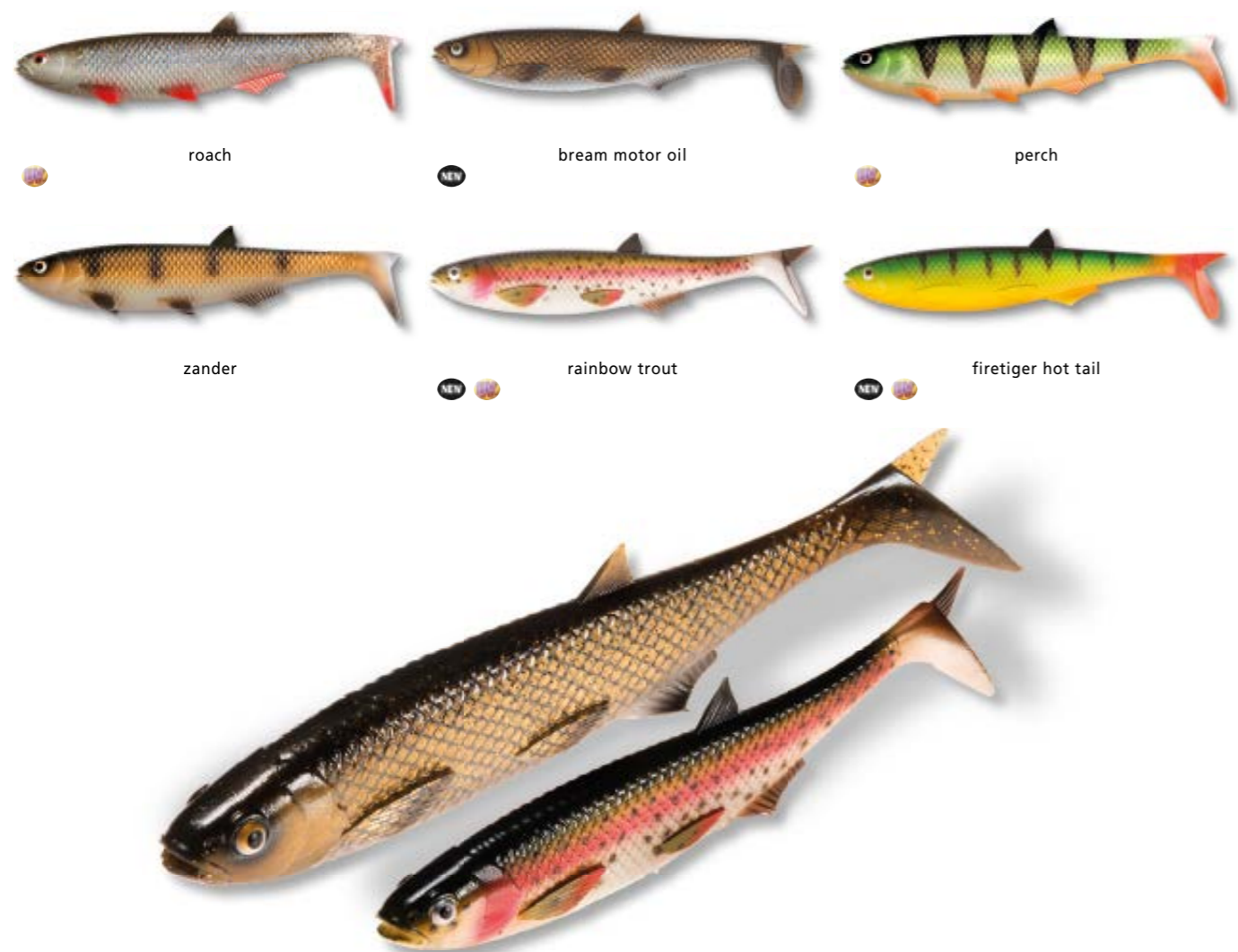

**YOLO PIKE SHAD**

The YOLO Pike Shad is a lure developed by the entire Quantum predator team specifically for large pike fishing. The YOLO moves tantalisingly with its entire body even with light weight heads, yet remains stable even on fast retrieves.

Length	Weight	Action	roach	bream motor oil	perch	zander	rainbow trout	firetiger hot tail
18 cm	33 g	sinking	3266 301	3266 302	3266 303	3266 304	3266 307	3266 308
22 cm	60 g	sinking	3266 401	3266 402	3266 403	3266 404	3266 407	3266 408
30 cm	122 g	sinking	3266 501				3266 507	3266 508

Trade Pack 5 Pieces



**YOLO CURLY SHAD**

The YOLO Curly Shad is a lure developed by the entire Quantum predator team specifically for targeting large fish. The sickle tail, which is specially adjusted to the body size, creates lateral movement of the entire body even in the slow sinking phase. The YOLO Curly Shad also has the huge plus point that, unlike many other large twisters on the market, its low weight allows fatigue-free fishing all day long without making compromises on lure size or requiring a special heavy rod and reel combination.

Length	Weight	roach	bream motor oil	perch	zander	rainbow trout	firetiger hot tail
21 cm	36 g	3270 301	3270 302	3270 303	3270 304	3270 307	3270 308
26 cm	64 g	3270 401	3270 402	3270 403	3270 404	3270 407	3270 408

Trade Pack 5 Pieces





**CRAWLING JACK**

Double-tail twister that flounders wildly in the water with two sickle-shaped lateral arms, driving the fish into a frenzy. Our test anglers tried the lure in freshwater for perch, pike and zander as well as in saltwater for bass, cod and pollock. As a result, we agreed upon seven colours with the team anglers. This innovative twister is an incredibly versatile lure, yielding fish on practically any water.

Length	Weight	Content	honey	baby bass	remedy	lava	firefly	jungle	fruit cake	cherry cola
6,5 cm	2,5 g	6 pcs	3234 208	3234 214	3234 229	3234 230	3234 231	3234 232	3234 233	3234 245
10 cm	8,5 g	5 pcs	3234 308	3234 314	3234 329	3234 330	3234 331	3234 332	3234 333	3234 345

Trade Pack 5 Pieces

**CRAWLING JACK PIKE-EDITION**

The Crawling Jack Pike „ready to fish“ is equipped with a 15g ultra-sharp jig hook and a robust additional treble allowing it to be used on the water immediately. The six different colour designs have been specially selected by our pike specialists Holger Aderkas and Lars Vormelker.

Length	Weight	Content	baby pike	baby bass	firefly	vanilla flash	motor oil
20 cm	60 g	1 pcs	3234 509	3234 514	3234 531	3234 534	3234 535

Trade Pack 5 Pieces



kompletný cenník na [www.SPORTS.sk](http://www.SPORTS.sk), výhradný distribútor pre SR: SPORTS s.r.o.



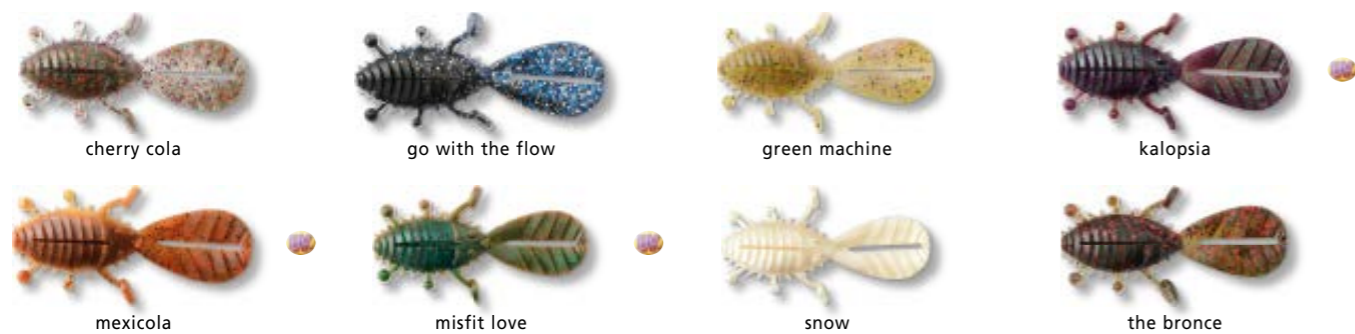

**RHINOSOR**

The Creature Bait, developed by French team anglers Eric Bagur and Andreas Wols, has been specially adapted for modern black bass fishing. The Creature has two small arm blades and six legs with a ball at the end, which create micro-vibrations under the water, driving predators wild.

Length	Weight	Content	cherry cola	go with the flow	green machine	kalopsia	mexicola	misfit love	snow	the bronze
9,5 cm	12 g	5 pcs	3298 001	3298 002	3298 003	3298 004	3298 005	3298 006	3298 007	3298 008

Trade Pack 5 Pieces



**FREDDIE SHAD**

Our team angler Lars Vormelker drew upon his many years of experience working as an angling guide to develop this must-have lure: The special paddle tail that folds down in flight and slender body shape create first-class casting properties. Anglers fishing from the bank will particularly appreciate these features. With their intricately devised moulding material, the Battle Shads boast an incredibly alluring swimming action that will quickly strike fear into predators. The interesting lure sizes offer sensible options for the entire market from large pike down to perch.

Length	Weight	Content	remedy	sunset	pink lady	zulu	opening night	chartreuse	hot brownie	bloody offspring
12 cm	5,5 g	5 pcs	3247 001	3247 002	3247 003	3247 004	3247 005	3247 006	3247 007	3247 008
17 cm	14 g	3 pcs	3247 101	3247 102	3247 103	3247 104	3247 105	3247 106	3247 107	3247 108
21,5 cm	24 g	2 pcs	3247 201	3247 202	3247 203	3247 204	3247 205	3247 206	3247 207	3247 208

Trade Pack 5 Pieces



**JOKER**

The revolutionary Joker Lure truly lives up to its name. Like an ace up your sleeve at the poker table, this lure ensures the angler always has a trump card in the tackle box. When retrieving or jigging, the lure genuinely appears to be moving in reverse. With its unique design and weight distribution, the Joker almost moves backwards from its starting position, remaining in the predator's field of vision for far longer. The hazards of hanging branches, tree trunks and overhanging banks are consigned to the past with this predator magnet! Now you can target the swims other lures simply cannot reach!

Length	Weight	Content	fudge head	baby bass	opening night	red rooster	firetiger	rainbow
8,5 cm	2 g	3 pcs	3239 001	3239 002	3239 003	3239 004	3239 005	3239 006
12 cm	4 g	3 pcs	3239 201	3239 202	3239 203	3239 204	3239 205	3239 206
12 cm	6 g	3 pcs		3239 302	3239 303	3239 304	3239 305	3239 306

Trade Pack 5 Pieces

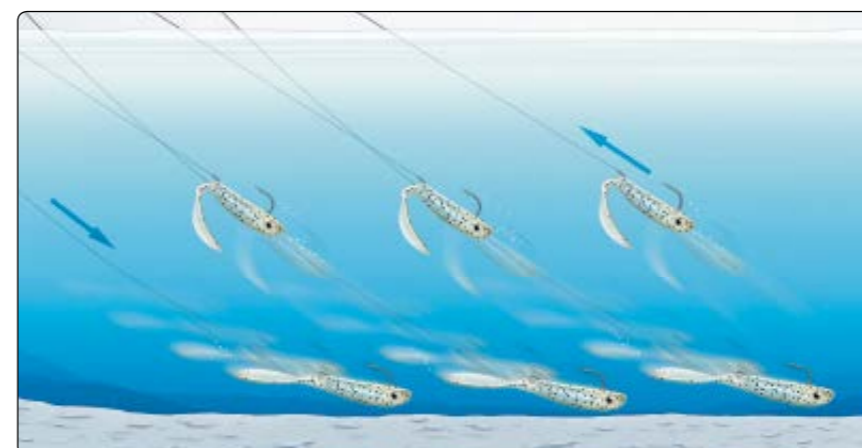
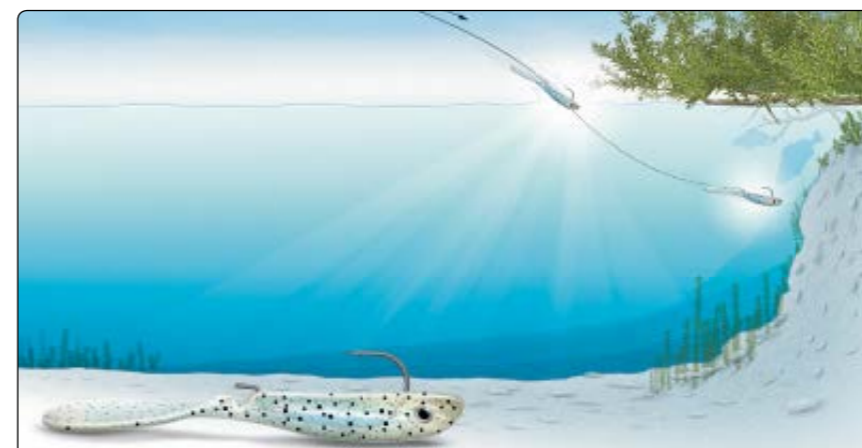



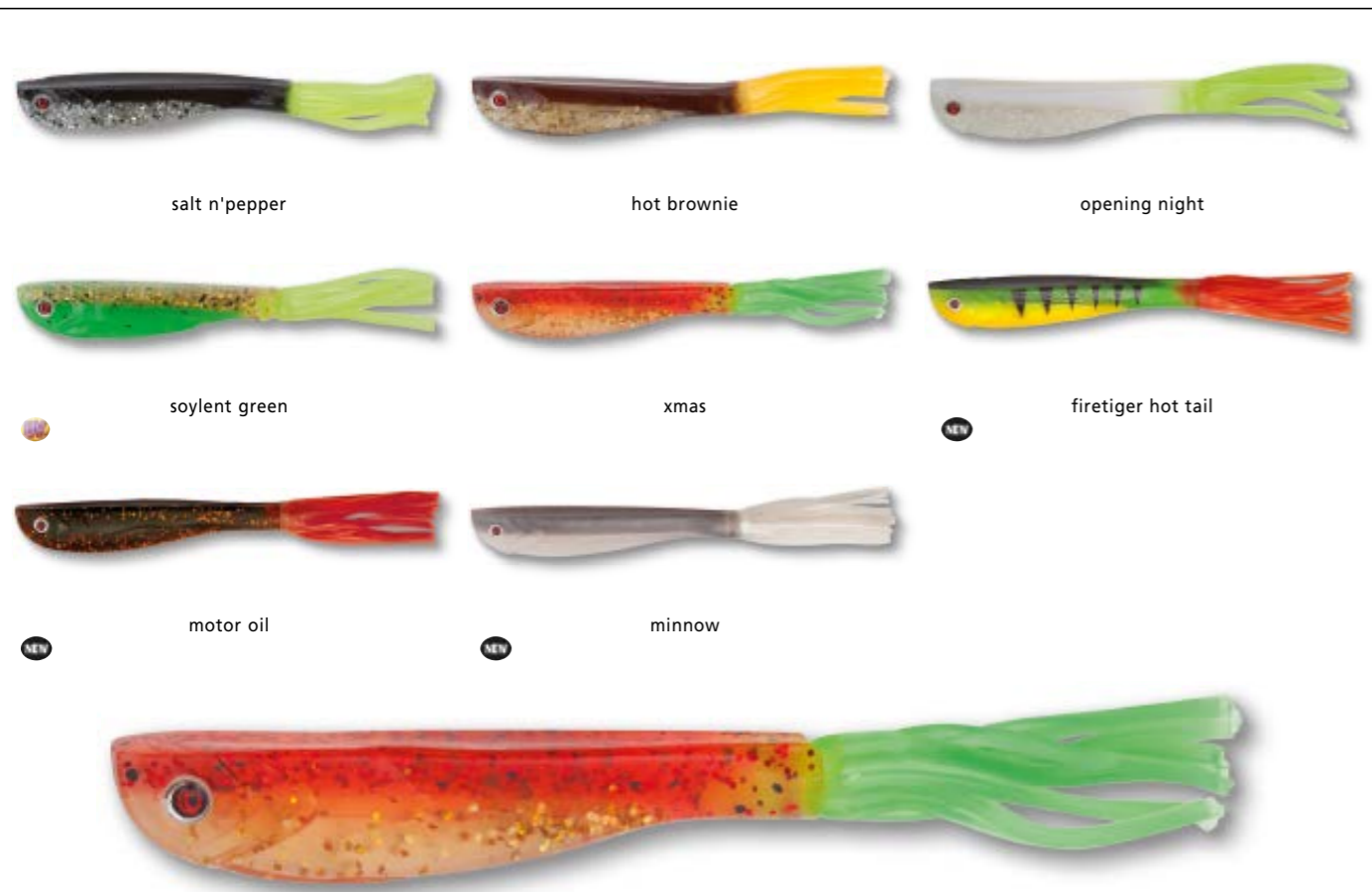

**HAIRY MARY**

Innovative fringed jig in three sizes and eight highly attractive designs. The rubber compound impresses with its shimmering colours and extreme softness. At the leading edge of the Hairy Mary is a neat hollowed-out channel designed for optimal hook presentation. Both sizes come with a groove along the stomach for use with offset hooks (e.g. when dropshot fishing). Holographic eyes complete the alluring package. In testing, the Hairy Mary, with its partly contrasting, moving fringes, demonstrated its extreme attraction to perch and zander while the larger of the two designs proved a hit with pike.

Length	Weight	Content	salt n'pepper	hot brownie	opening night	soylent green	xmas	firetiger hot tail	motor oil	minnow
10 cm	6,5 g	5 pcs	3242 001	3242 002	3242 004	3242 006	3242 007	3242 009	3242 010	3242 011
14 cm	12 g	3 pcs	3242 101	3242 102	3242 104	3242 106	3242 107	3242 109	3242 110	3242 111
20 cm	30 g	2 pcs	3242 201	3242 202	3242 204	3242 206	3242 207	3242 209	3242 210	3242 211

Trade Pack 5 Pieces

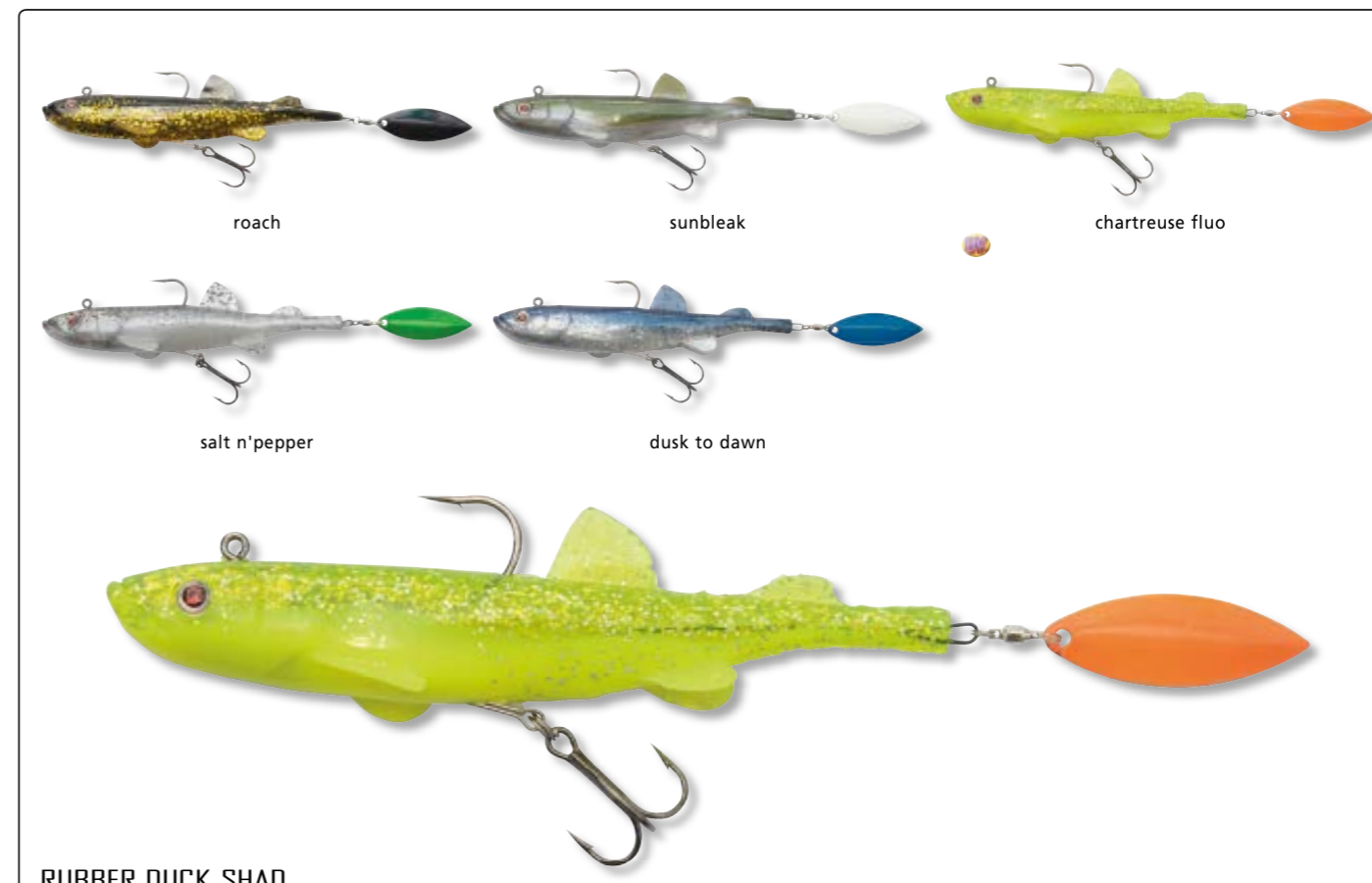

**RUBBER DUCK SHAD**

New jig with a rotating spinner blade as a tail, based upon our successful smelt shad. Equipped with a high-quality VMC treble, a stainless steel interior and high-quality steel leader materials for fixing the spinner blade for maximum flexibility of the soft plastic body.

Length	Weight	Content	Action	roach	sunbleak	chartreuse fluo	salt n'pepper	dusk to dawn
15 cm	17 g	1 pcs	sinking	3252 201	3252 202	3252 203	3252 204	3252 205
21 cm	60 g	1 pcs	sinking	3252 401	3252 402	3252 403	3252 404	3252 405

Trade Pack 5 Pieces

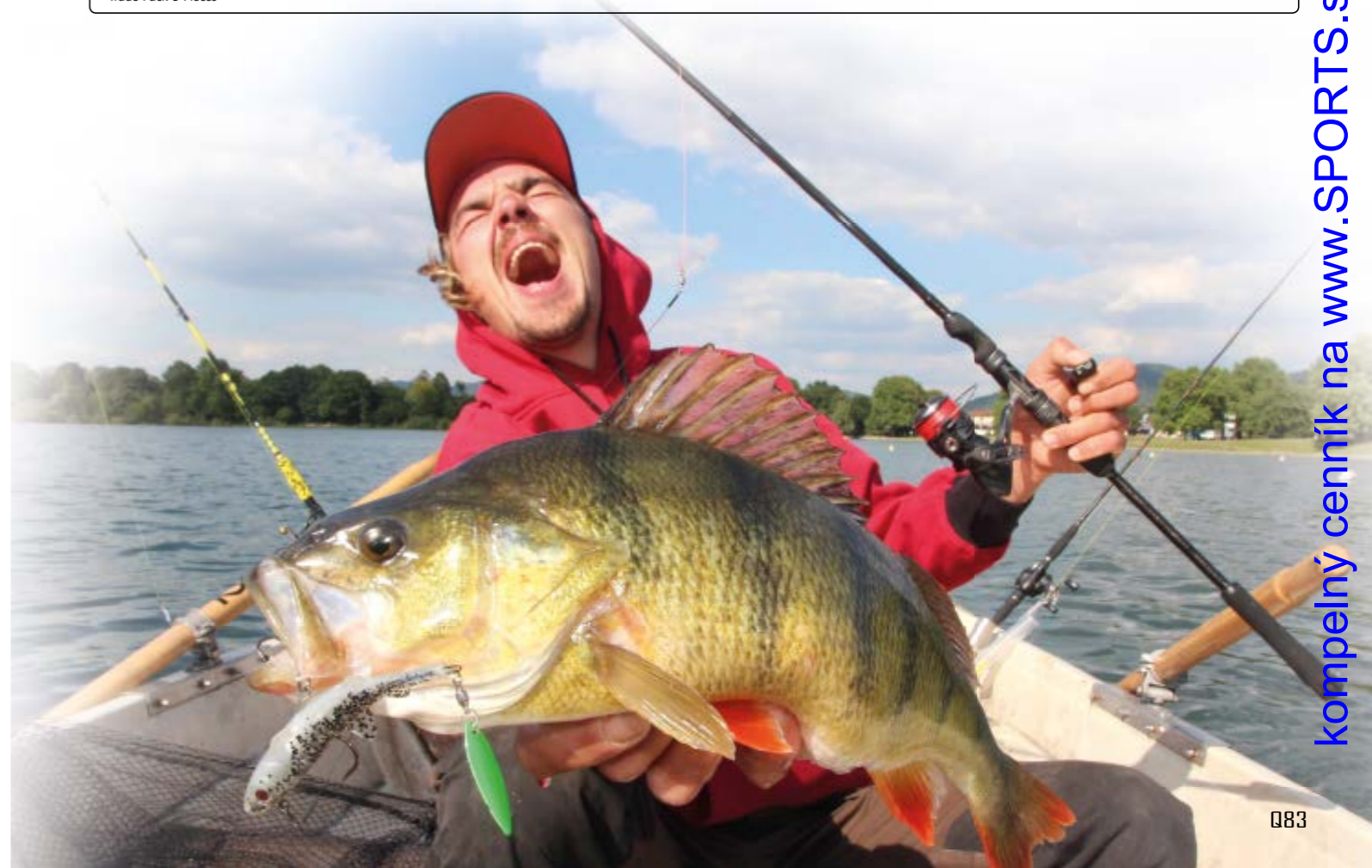





**RASSEL SHAD**

The Rassel Shad was the idea of Holger Aderkas and is introduced this year after a long test phase. The wagging tail contains a real glass rattle that drives fish crazy with the noises it creates as the lure is retrieved. The lure is available in three different sizes and seven colours allowing the angler to target any fish from perch and zander to pike with the lure.

Length	Weight	Content	dusk to dawn	salt n'pepper	rainbow	purple moon	dirty gold	delirium	baby bass
10 cm	8 g	64 pcs	3236 005	3236 001	3236 006	3236 013	3236 011	3236 012	3236 014
14 cm	22 g	40 pcs	3236 105	3236 101	3236 106	3236 113	3236 111	3236 112	3236 114
20 cm	65 g	24 pcs	3236 205	3236 201	3236 206	3236 213	3236 211	3236 212	3236 214



**VIBBA SHAD**

The Vibba Shad is the ultimate secret weapon when it comes to lures for difficult situations. Many anglers lack this type of lure in their armoury despite it making the difference between success and failure on many a day. The lure can be simply retrieved, trolled or jigged along the bottom. With a twitch of the rod, the entire lure starts to flutter, sending predators into a frenzy. The ultra-sharp hook on the belly is fitted with a spinner blade, providing additional attraction.

Length	Weight	Action	roach	perch	zander	vendace	firetiger
5 cm	5 g	sinking	3267 301	3267 303	3267 304	3267 305	3267 306
12 cm	50 g	sinking	3267 401	3267 403	3267 404	3267 405	3267 406

Trade Pack 5 Pieces







**PURE PASTE SET**

Set of four enticing attractive pastes (15 g each) for applying to artificial lures. Supplied with strap to hang the set from a fishing jacket, for example.

Code	Model	Weight
3949 000	4x	15 g / 60 g

Trade Pack 5 Pieces

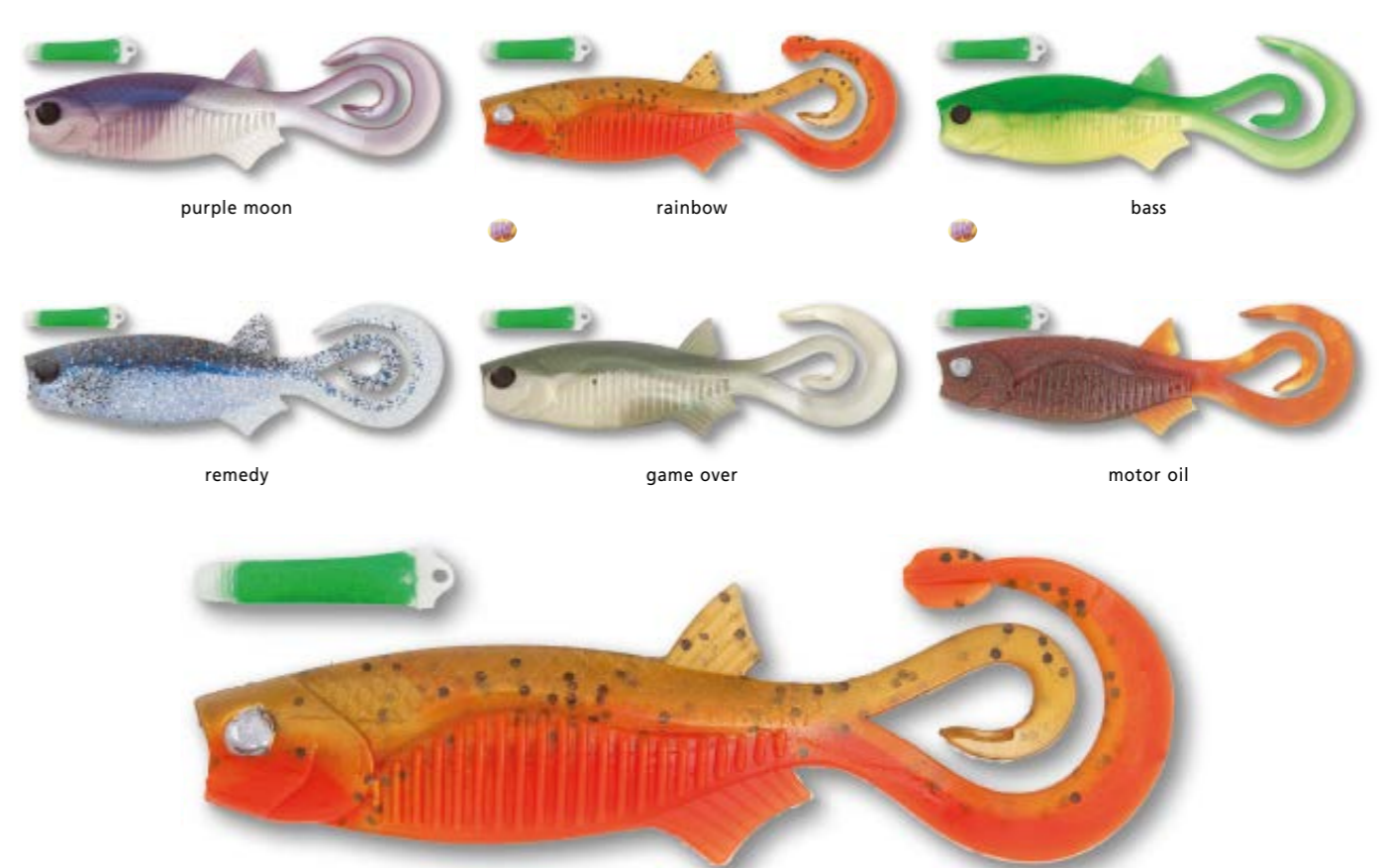
**SAPPY SHAD**

Innovative twister the like of which the world has never seen. The two different hook sizes provide a tantalising action even with the slightest movement of the lure. Grooves on the stomach provide an optimal grip for aromas. Also included is a specially developed smelt and gherkin aroma paste, which has brought significant success for our team anglers on many waters.

Length	Weight	Content	purple moon	rainbow	bass	remedy	game over	motor oil
7,5 cm	3,5 g	6 pcs	3262 201	3262 202	3262 203	3262 204	3262 205	3262 206
10 cm	8 g	4 pcs	3262 301	3262 302	3262 303	3262 304	3262 305	3262 306

Trade Pack 10 Pieces





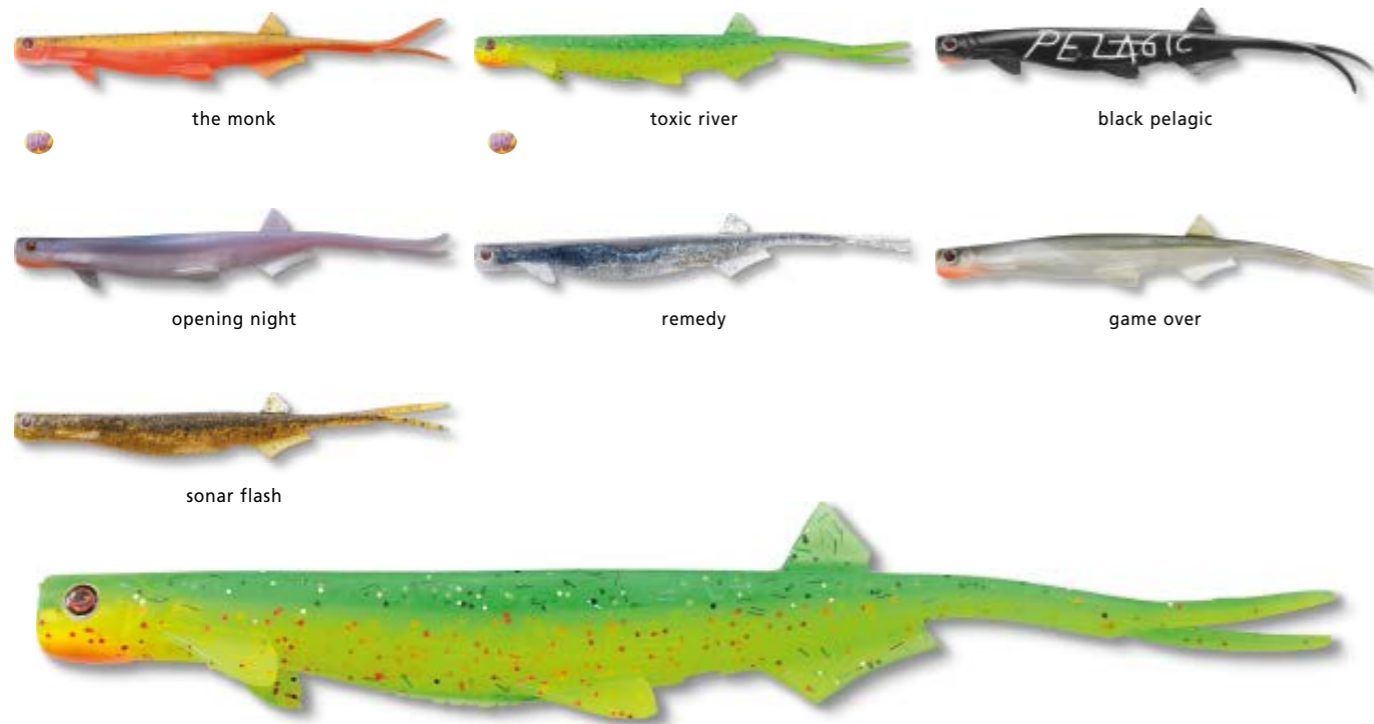

the monk

toxic river

black pelagic

opening night

remedy

game over

sonar flash

**PELAGIC SHAD**

The largest predators in our waters, whether monster zander or giant pike, spend the majority of the year living an inconspicuous, shadowy existence in the pelagic water column of our stillwaters. Catching such predators purposefully in mid-water requires expensively produced extreme lures that imitate typical prey down to the last detail. As one of the first manufacturers of „pelagic“ vertical lures in Europe, we present the Pelagic Shad from Quantum. Whether jigged vertically in open water or traditionally on the bottom – the Pelagic Shad is the key to your dream fish. During the revolutionary development phase, Fredrik Harbort and his friends outwitted countless open water giants in several countries around Europe with the lure. Besides the realistic design, the ultra-sensitive action also plays an essential role in successful mid-water angling. Those who are familiar with this type of fishing will quickly appreciate the benefits. The rules of open water just changed.

Length	Weight	Content	the monk	toxic river	black pelagic	opening night	remedy	game over	sonar flash
21 cm	23 g	2 pcs	3226 201	3226 203	3226 218	3226 202	3226 229	3226 210	3226 208
25 cm	37 g	2 pcs	3226 301	3226 303	3226 318	3226 302	3226 329	3226 310	3226 308

Trade Pack 5 Pieces



cod

mackerel

purple moon

black



**SKREY SHAD**

Fantastic imitation of a young cod. Ideal for halibut and large cod sport in northern Norway. Outstanding casting properties with a weight of 140 g. Fitted with a size 6/0 single hook and an additional treble. Available in six amazing colours and supplied assembled with spare tail.

Length	Weight	Content	Hook Size	cod	mackerel	purple moon	black
12 cm	80 g	1+2 pcs	5/0	3101 101	3101 104	3101 105	3101 106
15 cm	140 g	1+2 pcs	6/0	3101 301	3101 304	3101 305	3101 306
17 cm	250 g	1+2 pcs	8/0	3101 501	3101 504	3101 505	3101 506
19,5 cm	340 g	1+2 pcs	10/0	3101 701	3101 704	3101 705	3101 706

Trade Pack 5 Pieces



purple moon

lava

sardine

silver

sand eel



Length	Weight	Content	Hook Size	purple moon	lava	sardine	silver	sand eel
10 cm	12 g	1+2 pcs	2	3100 113	3100 130	3100 140	3100 141	3100 142
12 cm	20 g	1+2 pcs	1/0	3100 213	3100 230	3100 240	3100 241	3100 242
18 cm	65 g	1+2 pcs	5/0	3100 413	3100 430	3100 440	3100 441	3100 442
23,5 cm	150 g	1+2 pcs	7/0	3100 713	3100 730	3100 740	3100 741	3100 742

Trade Pack 5 Pieces

**TOBIZER**

Excellent sand eel imitation in three sizes and five attractive colour combinations. Sand eels are the main prey of many sea fish and rarely fail to work. Supplied with one head and two tails per pack.







CRYPTON LOB WORM HOOK-TO-NYLON

Code	Hook Size	Leader L. Ø	Hooklength	Content	Colour
4750 002	2	0,35 mm	70 cm	10 pcs	red
4750 004	4	0,30 mm	70 cm	10 pcs	red
4750 006	6	0,25 mm	70 cm	10 pcs	red
4750 008	8	0,20 mm	70 cm	10 pcs	red
4750 100	1/0	0,35 mm	70 cm	10 pcs	red

Trade Pack 10 Pieces



CRYPTON MAIZE HOOK-TO-NYLON

Code	Hook Size	Leader L. Ø	Hooklength	Content	Colour
4751 004	4	0,25 mm	70 cm	10 pcs	gold
4751 006	6	0,22 mm	70 cm	10 pcs	gold
4751 008	8	0,20 mm	70 cm	10 pcs	gold
4751 010	10	0,18 mm	70 cm	10 pcs	gold
4751 012	12	0,16 mm	70 cm	10 pcs	gold
4751 014	14	0,14 mm	70 cm	10 pcs	gold

Trade Pack 10 Pieces



CRYPTON FEEDER HOOK-TO-NYLON

Code	Hook Size	Leader L. Ø	Hooklength	Content	Colour
4736 010	10	0,18 mm	70 cm	10 pcs	black nickel
4736 012	12	0,16 mm	70 cm	10 pcs	black nickel
4736 014	14	0,14 mm	70 cm	10 pcs	black nickel
4736 016	16	0,12 mm	70 cm	10 pcs	black nickel
4736 018	18	0,12 mm	70 cm	10 pcs	black nickel

Trade Pack 10 Pieces



CRYPTON PASTE HOOK-TO-NYLON

Code	Hook Size	Leader L. Ø	Hooklength	Content	Colour
4735 004	4	0,25 mm	40 cm	5 pcs	red
4735 006	6	0,22 mm	40 cm	5 pcs	red
4735 008	8	0,22 mm	40 cm	5 pcs	red
4735 010	10	0,20 mm	40 cm	5 pcs	red

Trade Pack 10 Pieces



CRYPTON RED WORM HOOK-TO-NYLON

Code	Hook Size	Leader L. Ø	Hooklength	Content	Colour
4749 002	2	0,30 mm	70 cm	10 pcs	red
4749 004	4	0,30 mm	70 cm	10 pcs	red
4749 006	6	0,25 mm	70 cm	10 pcs	red
4749 008	8	0,22 mm	70 cm	10 pcs	red
4749 010	10	0,20 mm	70 cm	10 pcs	red

Trade Pack 10 Pieces



CRYPTON ALLROUND HOOK-TO-NYLON

Code	Hook Size	Leader L. Ø	Hooklength	Content	Colour
4734 004	4	0,25 mm	70 cm	10 pcs	black nickel
4734 006	6	0,25 mm	70 cm	10 pcs	black nickel
4734 008	8	0,22 mm	70 cm	10 pcs	black nickel
4734 010	10	0,20 mm	70 cm	10 pcs	black nickel
4734 012	12	0,18 mm	70 cm	10 pcs	black nickel
4734 014	14	0,16 mm	70 cm	10 pcs	black nickel
4734 016	16	0,14 mm	70 cm	10 pcs	black nickel

Trade Pack 10 Pieces



CRYPTON MAGGOT HOOK-TO-NYLON

Code	Hook Size	Leader L. Ø	Hooklength	Content	Colour
4748 010	10	0,16 mm	40 cm	10 pcs	black
4748 012	12	0,14 mm	40 cm	10 pcs	black
4748 014	14	0,12 mm	40 cm	10 pcs	black
4748 016	16	0,10 mm	40 cm	10 pcs	black
4748 018	18	0,10 mm	40 cm	10 pcs	black

Trade Pack 10 Pieces



CRYPTON BREAM HOOK-TO-NYLON

Code	Hook Size	Leader L. Ø	Hooklength	Content	Colour
4740 008	8	0,18 mm	80 cm	10 pcs	red
4740 010	10	0,16 mm	80 cm	10 pcs	red
4740 012	12	0,14 mm	80 cm	10 pcs	red
4740 014	14	0,12 mm	80 cm	10 pcs	red
4740 016	16	0,10 mm	80 cm	10 pcs	red

Trade Pack 10 Pieces





CRYPTON ROACH HOOK-TO-NYLON

Code	Hook Size	Leader L. Ø	Hooklength	Content	Colour
4741 010	10	0,16 mm	40 cm	10 pcs	blue
4741 012	12	0,14 mm	40 cm	10 pcs	blue
4741 014	14	0,12 mm	40 cm	10 pcs	blue
4741 016	16	0,10 mm	40 cm	10 pcs	blue
4741 018	18	0,10 mm	40 cm	10 pcs	blue

Trade Pack 10 Pieces



CRYPTON EEL HOOK-TO-NYLON

Code	Hook Size	Leader L. Ø	Hooklength	Content	Colour
4743 002	2	0,30 mm	70 cm	10 pcs	nickel
4743 004	4	0,30 mm	70 cm	10 pcs	nickel
4743 006	6	0,28 mm	70 cm	10 pcs	nickel
4743 008	8	0,25 mm	70 cm	10 pcs	nickel
4743 100	1/0	0,35 mm	70 cm	10 pcs	nickel

Trade Pack 10 Pieces



CRYPTON BOILIE HOOK-TO-NYLON

Code	Hook Size	Hooklength	BS	Content	Colour
4747 001	1	50 cm	15 kg	3 pcs	black/gunsmoke
4747 002	2	50 cm	15 kg	3 pcs	black/gunsmoke
4747 004	4	50 cm	15 kg	5 pcs	black/gunsmoke

Trade Pack 10 Pieces



CRYPTON BIG TROUT EXTREME HOOK-TO-NYLON

Code	Hook Size	Leader L. Ø	Hooklength	Content	Colour
4737 004	4	0,29 mm	180 cm	10 pcs	black nickel
4737 006	6	0,27 mm	180 cm	10 pcs	black nickel
4737 008	8	0,27 mm	180 cm	10 pcs	black nickel
4737 010	10	0,25 mm	180 cm	10 pcs	black nickel

Trade Pack 10 Pieces



CRYPTON CARP HOOK-TO-NYLON

Code	Hook Size	Leader L. Ø	Hooklength	Content	Colour
4744 002	2	0,35 mm	70 cm	10 pcs	black
4744 004	4	0,30 mm	70 cm	10 pcs	black
4744 006	6	0,28 mm	70 cm	10 pcs	black
4744 100	1/0	0,35 mm	70 cm	10 pcs	black

Trade Pack 10 Pieces



CRYPTON PERCH HOOK-TO-NYLON

Code	Hook Size	Leader L. Ø	Hooklength	Content	Colour
4745 004	4	0,25 mm	70 cm	10 pcs	black nickel
4745 006	6	0,22 mm	70 cm	10 pcs	black nickel
4745 008	8	0,20 mm	70 cm	10 pcs	black nickel
4745 010	10	0,20 mm	70 cm	10 pcs	black nickel

Trade Pack 10 Pieces



CRYPTON BIG TROUT HOOK-TO-NYLON

Code	Hook Size	Leader L. Ø	Hooklength	Content	Colour
4738 006	6	0,25 mm	120 cm	10 pcs	silver
4738 008	8	0,25 mm	120 cm	10 pcs	silver
4738 010	10	0,23 mm	120 cm	10 pcs	silver
4738 012	12	0,20 mm	120 cm	10 pcs	silver

Trade Pack 10 Pieces



CRYPTON BIG TROUT-BH HOOK-TO-NYLON

Code	Hook Size	Leader L. Ø	Hooklength	Content	Colour
4739 004	4	0,27 mm	220 cm	10 pcs	silver
4739 006	6	0,25 mm	220 cm	10 pcs	silver
4739 008	8	0,25 mm	220 cm	10 pcs	silver
4739 010	10	0,23 mm	220 cm	10 pcs	silver
4739 012	12	0,20 mm	220 cm	10 pcs	silver

Trade Pack 10 Pieces





CRYPTON TROUT PASTE HOOK-TO-NYLON

Code	Hook Size	Leader L. Ø	Hooklength	Content	Colour
4746 006	6	0,22 mm	70 cm	5 pcs	gold
4746 008	8	0,20 mm	70 cm	5 pcs	gold
4746 010	10	0,18 mm	70 cm	5 pcs	gold
4746 012	12	0,16 mm	70 cm	5 pcs	gold
4746 106	6	0,25 mm	250 cm	5 pcs	gold
4746 108	8	0,25 mm	250 cm	5 pcs	gold
4746 110	10	0,22 mm	250 cm	5 pcs	gold

Trade Pack 10 Pieces



CRYPTON TROUT HOOK-TO-NYLON

Code	Hook Size	Leader L. Ø	Hooklength	Colour
4742 006	6	0,22 mm	150 cm	black nickel
4742 008	8	0,20 mm	150 cm	black nickel
4742 010	10	0,18 mm	150 cm	black nickel
4742 012	12	0,16 mm	150 cm	black nickel
4742 106	6	0,22 mm	70 cm	black nickel
4742 108	8	0,20 mm	70 cm	black nickel
4742 110	10	0,18 mm	70 cm	black nickel
4742 112	12	0,16 mm	70 cm	black/nickel

Trade Pack 10 Pieces



DEAD BAIT SYSTEM

The Dead Bait System is supplied in three or four different weights and in two sizes. There is no fixed axis between the weight head and baitfish, meaning that the baitfish follows the weight head alluringly when jigging, rather than appearing static and dead.

Code	Model	BS
4206 005	Trout/Perch	5 g
4206 007	Trout/Perch	7 g
4206 010	Trout/Perch	10 g
4206 013	Trout/Perch	13 g

Trade Pack 10 Pieces

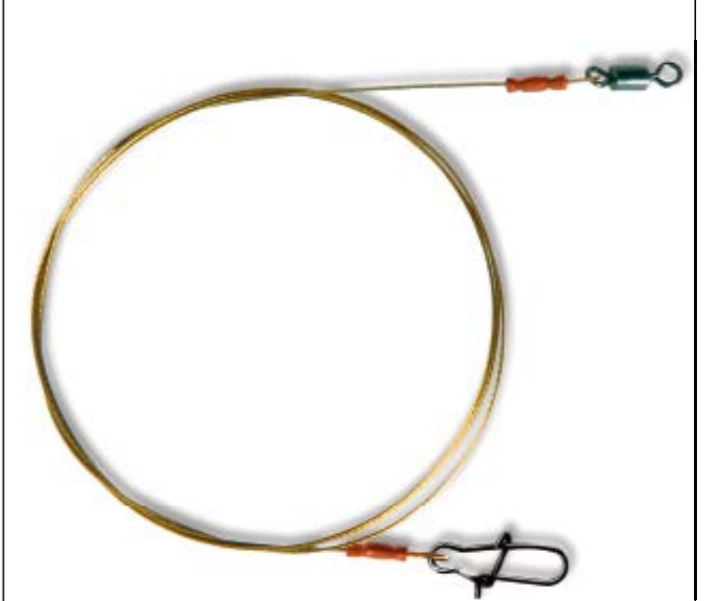

ULTRA WIRE LEADER

Extra thin, uncoated leader for inconspicuous and safe use.

Code	Length	BS	Content
2328 005	50 cm	5,4 kg / 12 lbs	5 pcs
2328 009	50 cm	9 kg / 19,5 lbs	5 pcs
2328 011	50 cm	11 kg / 24 lbs	5 pcs
2328 016	50 cm	16 kg / 35 lbs	5 pcs

Trade Pack 10 Pieces



DEAD BAIT SYSTEM

The Dead Bait System is supplied in three or four different weights and in two sizes. There is no fixed axis between the weight head and baitfish, meaning that the baitfish follows the weight head alluringly when jigging, rather than appearing static and dead.

Code	Model	BS
4207 007	Pike/Zander	7 g
4207 010	Pike/Zander	10 g
4207 013	Pike/Zander	13 g

Trade Pack 10 Pieces



DEAD MINNOW SYSTEM

The Dead Minnow System is supplied in three different weights. The system is popular on French rivers. It has a stiff axis between weight head and baitfish to prevent the deadbait from turning over on the cast and transmits subtle twitches on the retrieve better than a loose system.

Code	BS
4208 005	5 g
4208 007	7 g
4208 010	10 g

Trade Pack 10 Pieces





Will withstand endless pike attacks!

**TITANIUM LEADER**

Stainless Steel leaders are all well and good – but those who want the very best in tackle developments cannot ignore the unique properties of Titanium. Twisted or kinked leaders are a thing of the past. You couldn't damage these leaders even if you really tried! Long lasting so cost effective. Available either in a monofilament version or as 7-ply braid.

Code	Model	Length	Ø	BS
2329 010	1 strand	0,35 m	0,30 mm	10 kg
2329 019	1 strand	0,35 m	0,40 mm	19 kg
2329 031	1 strand	0,35 m	0,50 mm	31 kg

Trade Pack 5 Pieces

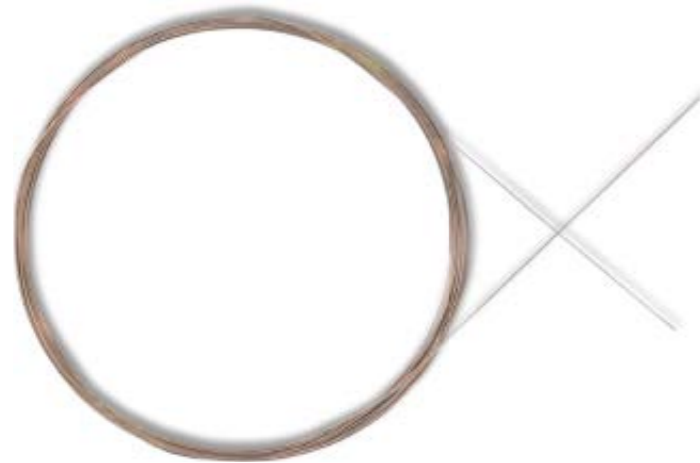

**TITANIUM STRECH WIRE LEADER**

One-strand Titanium Wire Leader on a 3 m spool for making leaders, rigs and stingers.

Code	Length	BS
2329 103	3 m	3 kg / 6 lbs
2329 105	3 m	5 kg / 12 lbs
2329 108	3 m	8 kg / 18 lbs
2329 111	3 m	11 kg / 25 lbs
2329 125	3 m	25 kg / 45 lbs

Trade Pack 5 Pieces



**COATED STEEL TRACE**

Special 1x7 steel leader material with coating for heavy-duty use. Includes 100 suitable pinch sleeves.

Code	Length	BS	Colour
2315 005	20 m	4,60 kg / 10 lbs	black
2315 006	20 m	6,00 kg / 15 lbs	black
2315 010	20 m	10,0 kg / 25 lbs	black
2315 018	20 m	18,0 kg / 40 lbs	black

Trade Pack 10 Pieces



**ULTRA WIRE LEADER SPOOL**

Super soft steel traces or bulk material with sleeves for crimping. The many threads and perfect braiding produces optimal angling properties. This fine brown trace offers reliable protection against teeth without spooking wary predators. With 50 crimps.

Code	Length	BS
2328 303	15 m	2,5 kg / 5,5 lbs
2328 305	15 m	5,4 kg / 12 lbs
2328 309	15 m	9 kg / 19,5 lbs
2328 311	15 m	11 kg / 24 lbs
2328 316	15 m	16 kg / 35 lbs

Trade Pack 10 Pieces



**“Mr. Pike” is the perfect range for all seasoned predator anglers which prefer to fish for bigfish with deadbaits. A classical method – interpreted in a modern fashion and perfectly delivered. That’s what “Mr. Pike” is all about.**



**Mr. Pike – “traditional pike fishing spot on!”**

Our new product range “Mr. Pike” is the perfect range for all seasoned predator anglers who still rely on deadbaits. Here you can find a straightforward range of rigged-up pike traces made from the finest multistrand American Fishing Wire (AFW) with an inconspicuous “Camo”-coated surface. A material that is one third thinner than conventional steel trace material and that adapts perfectly to water coloration and the bottom of the swim, resulting in clearly improved catches when compared to black wire, for example.

The range also includes the corresponding small materials and a fully compatible selection of perfectly balanced floats for all sizes of bait and any kind of presentation. This very special range is highlighted by four extraordinary rods for pike and zander fishing from the bank or boat. And, last but not least, clothing and practical bags for storing the traces, rigged-up rods and tackle together with frozen deadbaits.





**NEW**  
MADE IN GERMANY

**MR. PIKE PENCIL SLIDER**

When it comes to deadbait floats, it has to be the Mr. Pike 'Pencil Slider'! Optimal line flow, very low water displacement on a bite and optimal visibility in all weather conditions - what more could you want from a perfect predator float? Produced from indestructible Rohacell - made in Germany!

Code	Length	BS	Colour
5240 001	110 mm	10 g	black
5240 002	150 mm	20 g	black
5240 003	180 mm	30 g	black

Trade Pack 5 Pieces



**NEW**  
MADE IN GERMANY

**MR. PIKE FAT SLIDER**

Typical inline pike float! The slightly stocky float body of the Mr. Pike 'Fat Slider' is extremely stable in the wind and waves and highly visible in the water. Despite the rather small and compact body, the float is very buoyant, which makes it a true all-rounder. Produced from indestructible Rohacell - made in Germany!

Code	Length	BS	Colour
5241 001	155 mm	10 g	black
5241 002	165 mm	20 g	black
5241 003	175 mm	30 g	black

Trade Pack 5 Pieces



**NEW**  
MADE IN GERMANY

**MR. PIKE TROLLING FLOAT**

A must for every seasoned pike angler - the Mr. Pike 'Trolling Float'! This ideal trolling float for deadbaiting behind a boat is equipped with an integrated self-clamping device that prevents the main line from running through the float when pull is applied. This ensures that the baitfish always remains at the depth pre-determined by the angler and does not wander upwards through the line stopper. Produced from indestructible Rohacell - made in Germany!

Code	Length	BS	Colour
5244 001	125 mm	30 g	black
5244 002	125 mm	40 g	black

Trade Pack 5 Pieces



**NEW**  
MADE IN GERMANY

**MR. PIKE ZANDER FLOAT**

A Dutch classic! A faithful reproduction of the most popular zander float of Dutch 'Snoekbaars' experts. Holds firm in the wind yet indicates even the finest bites from these cautious predators. Innovation: the snaplight option on the sensitive antenna! Produced from indestructible Rohacell - made in Germany!

Code	Length	BS	Colour
5245 001	280 mm	3 g	black
5245 002	280 mm	4 g	black
5245 003	280 mm	5 g	black

Trade Pack 5 Pieces



**NEW**  
MADE IN GERMANY

**MR. PIKE DRIFT FLOAT**

It's here: a drift float with a sail and snaplight holder! The Mr. Pike 'Drifter Float' is a slider with a replaceable, stable plastic sail. The sail can either accommodate a snaplight or be replaced with a snaplight. Produced from indestructible Rohacell - made in Germany!

Code	Length	BS	Colour
5242 001	125 mm	20 g	black
5242 002	125 mm	30 g	black
5242 003	125 mm	40 g	black

Trade Pack 5 Pieces



**NEW**  
MADE IN GERMANY

**MR. PIKE PENCIL LOADED**

Sometimes, anglers are forced to present their deadbait either on or off the bottom with a float rig rather than legering due to the amount of vegetation. This is where the Mr. Pike 'Pencil Loaded' float comes into its own. Produced from indestructible Rohacell - made in Germany! Lead-free!

Code	Length	BS	Colour
5243 001	150 mm	15 / 10 g	black

Trade Pack 5 Pieces



**NEW**

**MR. PIKE BAIT POP UP KIT**

Three intelligently designed floating devices for every conceivable application on the water. The round ball is designed for offering floating whole deadbaits, the half ball allows a half deadbait or large deadbait chunks to be presented tantalisingly off the bottom and the drop-shaped floating device presents smaller deadbaits attractively on a leger rig. The integrated supporting bar allows the 'Bait Pop Ups' to be fixed simply and securely.

Code	Content	Colour
6240 001	3 pcs	red

Trade Pack 5 Pieces







NEW

**MR. PIKE CAMO COATED LEADER MATERIAL**

In American Fishing Wire, Mr. Pike brings a camo-coated steel leader material to the market which is up to a third thinner in diameter than comparable nylon-coated steel leaders available. The coating has a genuine camouflage effect since the leader adapts to the natural colour of the bottom of the water. In countless field tests, anglers have not only hooked significantly more fish with the camo steel leader but also larger and shyer predators. The Mr. Pike 'Camo Leader' material is available on 10-metre spools in a variety of breaking strains for fine zander and eel to large pike fishing.

Code	Length	BS	Colour
2355 001	10 m	7 kg / 15 lbs	camou
2355 002	10 m	9 kg / 20 lbs	camou
2355 003	10 m	14 kg / 30 lbs	camou

Trade Pack 5 Pieces



NEW

**MR. PIKE POWER SLEEVES**

First-class steel leader holds firm in the only weak spot a leader has with these - Original American Fishing Wire pinch sleeves in the right size for the steel diameter! The best pinch sleeves on the market are also available separately in our Mr. Pike range.

Code	Model	Ø	Content	Colour
6415 084	S	0,84 mm	50 pcs	mat black
6415 119	M	1,19 mm	50 pcs	mat black
6415 140	L	1,40 mm	50 pcs	mat black
6415 180	XL	1,80 mm	50 pcs	mat black

Trade Pack 5 Pieces



NEW

**MR. PIKE UNIVERSAL LEADER**

Mr. Pike Universal Leader - ready-made rigs for float fishing and legering, equipped with high-quality carbon steel hooks tied onto 30 lb (14 kg) inconspicuous camo steel leader. High-quality production is of the utmost priority with each pinch sleeve connection being made individually by hand and inspected.

Code	Hook Size	Hook	Length	BS	Colour
4272 001	4	2	60 cm	13,60 kg / 30 lbs	camou
4272 002	6	2	60 cm	13,60 kg / 30 lbs	camou
4272 003	8	2	60 cm	13,60 kg / 30 lbs	camou

Trade Pack 5 Pieces



NEW

**MR. PIKE LONG CAST LEADER**

Mr. Pike Long Cast Leader - ready-made rigs for float fishing and legering, especially for long casting, equipped with high-quality carbon steel hooks tied onto 30 lb (14 kg) inconspicuous camo steel leader. High-quality production is of the utmost priority with each pinch sleeve connection being made individually by hand and inspected.

Code	Hook Size	Hook	Length	BS	Colour
4273 001	4	2	60 cm	13,60 kg / 30 lbs	camou
4273 002	6	2	60 cm	13,60 kg / 30 lbs	camou
4273 003	8	2	60 cm	13,60 kg / 30 lbs	camou

Trade Pack 5 Pieces



NEW

**MR. PIKE FLOAT RIG LEADER**

Float Rig Leader - ready-made rigs for float fishing, equipped with high-quality carbon steel hooks tied onto 30 lb (14 kg) inconspicuous camo steel leader. High-quality production is of the utmost priority with each pinch sleeve connection being made individually by hand and inspected.

Code	Hook Size	Hook	Length	BS	Colour
4271 001	1/4	2	60 cm	13,60 kg / 30 lbs	camou

Trade Pack 5 Pieces



NEW

**MR. PIKE BOTTOM RIG LEADER**

Bottom Rig Leader - ready-made rigs for legering, equipped with high-quality carbon steel hooks tied onto 30 lb (14 kg) inconspicuous camo steel leader. High-quality production is of the utmost priority with each pinch sleeve connection being made individually by hand and inspected.

Code	Hook Size	Hook	Length	BS	Colour
4271 002	6	1	50 cm	13,60 kg / 30 lbs	camou
4271 003	4	1	50 cm	13,60 kg / 30 lbs	camou
4271 004	2	1	50 cm	13,60 kg / 30 lbs	camou

Trade Pack 5 Pieces



NEW

**MR. PIKE SLIDE SINKER LEAD-FREE**

Completely lead-free! The Mr. Pike 'Slide Sinkers' are weights that can be attached to the main line in one of two ways. One way is as a sliding weight guided through the tube, which ensures free weighting of the rig without resistance. The other is as a fixed weight via the silicone tubes supplied. These are threaded onto the main line and the 'Slide Sinker' is inserted and fixed at the required distance.

Code	Hook Size	Hook	Length	BS	Colour
4274 001	6/4	2	60 cm	13,60 kg / 30 lbs	camou
4274 002	8/6	2	60 cm	13,60 kg / 30 lbs	camou

Trade Pack 5 Pieces

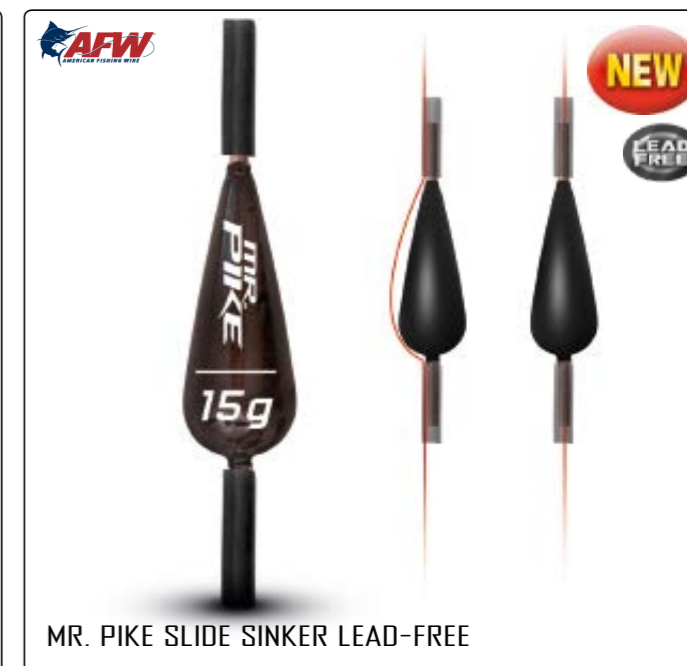

NEW

**MR. PIKE SLIDE SINKER LEAD-FREE**

Completely lead-free! The Mr. Pike 'Slide Sinkers' are weights that can be attached to the main line in one of two ways. One way is as a sliding weight guided through the tube, which ensures free weighting of the rig without resistance. The other is as a fixed weight via the silicone tubes supplied. These are threaded onto the main line and the 'Slide Sinker' is inserted and fixed at the required distance.

Code	Weight	Content	Colour
6233 006	6 g	3 pcs	black
6233 010	10 g	3 pcs	black
6233 015	15 g	3 pcs	black
6233 020	20 g	3 pcs	black

Trade Pack 10 Pieces





**NEW**

**MR. PIKE SPOTTY**

Biting - let's get to the point! The Mr. Pike 'Spotty' has you covered. On the one hand, it provides a visual incentive for predators. On the other hand, the 'Spotty' can be used as a stopper to prevent deadbaits from falling off the hook during casting. Not only does it decorate your plain deadbait, it also clearly shows the predator where it should bite.

Code	Size	Content	Colour
3113 001	XL	20 pcs	UV colours

Trade Pack 5 Pieces



**NEW**

**MR. PIKE FLOAT STOPS SILICONE**

Guaranteeing a firm grip on large floats is not always easy, which is why high-quality silicone float stoppers are a must. The black Mr. Pike 'Float Stops' are the ideal solution. They are suited to both monofilament and braided lines and fit optimally on line diameters of 0.2 mm - 0.40 mm.

Code	Model	Content	Colour
3117 001	L	20 pcs	black

Trade Pack 5 Pieces



**NEW**

**MR. PIKE HOODY**

Material: 100% Cotton. Gram weight: 360 g/m<sup>2</sup>

Code	Size	Colour
8450 000	S	black
8450 001	M	black
8450 002	L	black
8450 003	XL	black
8450 004	XXL	black
8450 005	XXXL	black



**NEW**

**MR. PIKE BEANIE**

Thinsulate! Extra warm. Material: 100% Cotton

Code	Colour
9788 071	grey

Trade Pack 5 Pieces



**NEW**

**MR. PIKE RIGGING KIT**

A DIY kit for all pike anglers who appreciate innovative quality but want to remain flexible. The Mr. Pike 'Rigging Kit' includes optimal trebles for deadbaiting and our camo-coated plastic sleeves for putting together an inconspicuous leader.

Code	Hook Size	Content	Colour
6208 000	4	12 pcs	camou
6208 001	6	12 pcs	camou
6208 002	8	12 pcs	camou

Trade Pack 5 Pieces



**NEW**

**MR. PIKE KWIK CHANGE SWIVEL KIT**

Incredibly practical to use, particularly when unhooking a landed fish. The intelligent Mr. Pike 'Kwik Change' carabiner at the end of the swivel enables rapid removal of the steel leader even in the landing net. Protects both the fish and your rig. The kit comprises the Kwik Change swivel and matching Safety Sleeves that act like a second skin around the individual rig components. The Mr. Pike 'Safety Sleeves' come in a light sand-camo colour that perfectly matches our camo leader material.

Code	Size	BS	Content
6209 001	L	36 kg	16 pcs

Trade Pack 5 Pieces



**NEW**

**MR. PIKE PIKE SCOOPER**

Room for a monster! A landing net with floating devices on both corners combined with a robust full metal frame including an extra-long thread - a must for every big pike angler. The extremely robust landing net handle provides sufficient support and stability to land fish of any size. The protective net with its flat bottom rounds off the attractive design.

Code	Length	Width	Height	Mesh
7024 001	1,91 m	93 cm	84 cm	8 x 8 mm



**NEW**

**MR. PIKE ROD CASE**

Secure and reliable on the water. The upholstered rod holdall in single sleeve design offers sufficient storage even for long-cast rods with large rings. A smart extra for documenting your large catches is the printed tape measure on the rear of the bag. The Mr. Pike 'Rod Case' is equipped with a robust zip fastener and is loaded with rigged-up rods and reels from above.

Code	Length	Colour
8517 060	190 cm	black





NEW

MR. PIKE TRACE WALLET

The perfect solution for kink-free storage of rigged pike leaders. Unlike a rig bin, the luxury rig wallet allows the steel leaders to be laid out in extended form as well as being easily removed and replaced after use. The robust foam panel of the Mr. Pike 'Trace Wallet' provides space for up to 24 ready-made pike leaders. Material: 100% Polyester



Code	Length	Colour
8517 067	65 cm	black



NEW

MR. PIKE CARRYALL + FREEZER BAG

An ingenious combination for all stationary predator anglers - a spacious shoulder bag for all kinds of tackle and accessories combined with a removable cool bag! The Mr. Pike 'Carryall' is designed to accommodate all conventional tackle boxes. The second section of the bag - the 'freezer bag' is equipped with a particularly thick iso-layer to ensure trouble-free storage of deadbaits over a long period. The freezer bag is also removable, allowing it to be stored separately while fishing and cleaned after use. Material: 100% Polyester

Code	Width	Height	Depth	Colour
8517 065	45 cm	35 cm	40 cm	black



Length	Model	Content	Action	silver	gold	copper	gunsmoke	firetiger
17 mm	Indiana	2 pcs	sinking	3331 001	3331 002	3331 003	3331 004	3331 005
30 mm	Indiana	2 pcs	sinking	3331 101	3331 102	3331 103	3331 104	3331 105

Trade Pack 5 Pieces

SCREW IN BLADE

Extra spinner blade that can be screwed easily into a deadbait or soft lure, providing additional temptation for predators to bite.



Length	Model	Content	Action	silver	gold	copper	gunsmoke	firetiger
30 mm	Willow Leaf	2 pcs	sinking	3332 001	3332 002	3332 003	3332 004	3332 005
42 mm	Willow Leaf	2 pcs	sinking	3332 101	3332 102	3332 103	3332 104	3332 105

Trade Pack 5 Pieces

SCREW IN BLADE

Extra spinner blade that can be screwed easily into a deadbait or soft lure, providing additional temptation for predators to bite.





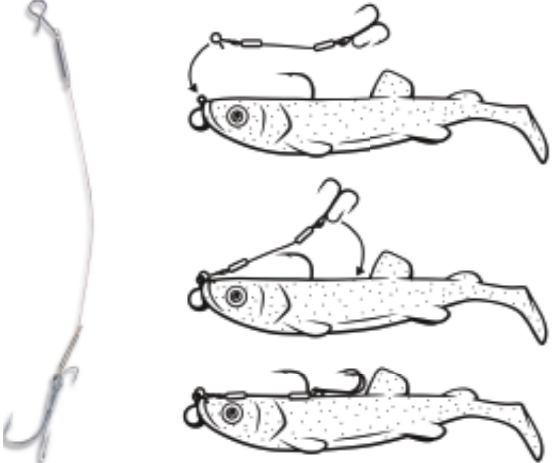

### SECOND CHANCE STINGER RIG

Now Quantum has the ideal stinger for vertical zander fishing in its range. The Second Chance Stinger Rig comprises an extra-strong quick-clip at one end for simple attachment to the jig head eye and an ultra-sharp stinger hook on the other end, whereby one hook tip is arranged the other way around on the hook shank for fixing to the soft lure or baitfish.

Code	Length	Hook Size	Content
4213 007	6,5 cm	6	3 pcs
4213 109	9 cm	4	3 pcs
4213 112	12 cm	4	3 pcs

Trade Pack 10 Pieces

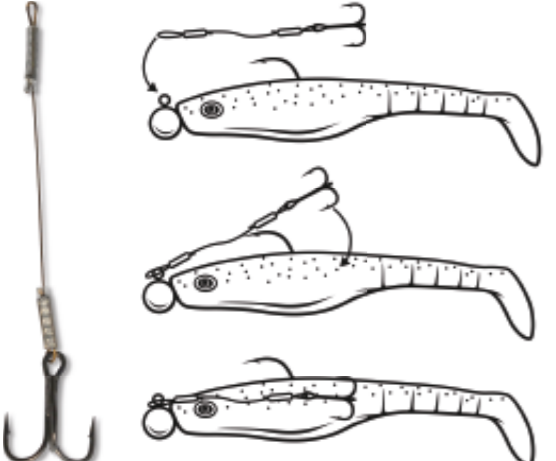

### SECOND CHANCE RIG

Needle-sharp treble with high quality leader as an additional treble for soft lure or baitfish as a single or double rig. At the other end is a loop that can be pulled easily through the eye of the jig head. This guarantees quick and secure attachment while fish that bite cautiously on the rear end of the bait are hooked securely.

Code	Length	Hook Size	Content
4214 007	7 cm	8	3 pcs
4214 010	10 cm	8	3 pcs
4214 107	7 cm	6	3 pcs
4214 110	10 cm	6	3 pcs

Trade Pack 10 Pieces

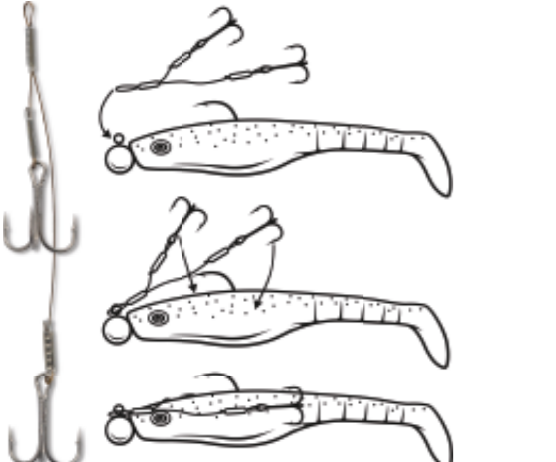

### SECOND CHANCE DOUBLE RIG

Needle-sharp treble with high quality leader as an additional treble for soft lure or baitfish as a single or double rig. At the other end is a loop that can be pulled easily through the eye of the jig head. This guarantees quick and secure attachment while fish that bite cautiously on the rear end of the bait are hooked securely.

Code	Length	Hook Size	Content
4215 010	10 cm	6	2 pcs
4215 110	10 cm	4	2 pcs

Trade Pack 10 Pieces



### BIG EYE HOOK

Ultra-sharp single hook with large eye, specially designed for use on wobblers, spoons, etc.

Code	Hook Size	Content	Colour
4480 001	1	10 pcs	tin
4480 002	2	10 pcs	tin
4480 004	4	10 pcs	tin
4480 006	6	10 pcs	tin
4480 008	8	10 pcs	tin
4480 200	2/0	10 pcs	tin

Trade Pack 10 Pieces



### YOLO SHAD SYSTEM

The new YOLO Shad System is the innovation for all predator anglers who want to present their soft lures at all standard depths using just one rig! The weight head is divided into three parts, allowing the angler to fish with 8 different weights, and hence at the same number of depths or speeds, simply by rotating these parts. Equipped with two ultra-sharp carbon steel hooks, the rig ensures secure hooking and can be quickly and easily combined with a wide variety of soft lures.

Code	Model	Hook Size	Hook	BS	Content
4239 001	M	1/2	2	40 kg	1 pcs
4239 002	L	1/0/1	2	40 kg	1 pcs

Trade Pack 5 Pieces

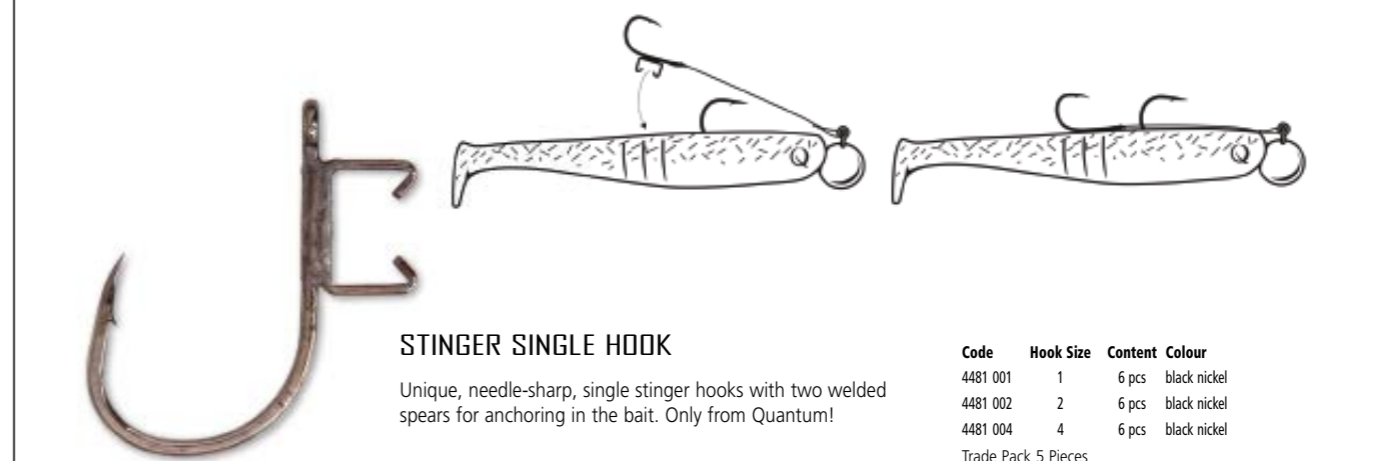

### STINGER SINGLE HOOK

Unique, needle-sharp, single stinger hooks with two welded spears for anchoring in the bait. Only from Quantum!

Code	Hook Size	Content	Colour
4481 001	1	6 pcs	black nickel
4481 002	2	6 pcs	black nickel
4481 004	4	6 pcs	black nickel

Trade Pack 5 Pieces



### DROPSHOT OFFSET HOOK

Code	Hook Size	Content	Colour
4373 001	1	5 pcs	black nickel
4373 100	1/0	4 pcs	black nickel
4373 200	2/0	4 pcs	black nickel
4373 300	3/0	3 pcs	black nickel
4373 500	5/0	2 pcs	black nickel

Trade Pack 10 Pieces



### BIG PIKE OFFSET HOOK

There is an abundance of weighted offset hooks on the market. Unfortunately, those designed for bass fishing are often too small for our European fish. Quantum has brought two new sizes to the market specifically for today's requirements, allowing the angler to fish with typical bait sizes in Europe without weed interfering.

Code	Length	Hook Size	Weight	Content	Colour
3116 310	7,2 cm	8/0	10 g	3 pcs	black nickel
3116 320	7,2 cm	8/0	20 g	3 pcs	black nickel
3116 510	9,0 cm	11/0	10 g	2 pcs	black nickel
3116 520	9,0 cm	11/0	20 g	2 pcs	black nickel

Trade Pack 5 Pieces







**JIG HEAD**

With a choice of round head or flattened sledge shape. Super sharp VMC hooks which hook the predator securely and do not bend even in the toughest fights.

Code	Hook Size	Weight
3170 100	1	5,0 g
3170 101	1/0	5,0 g
3170 200	1	7,5 g
3170 201	1/0	7,5 g
3170 001	2/0	10 g
3170 002	2/0	15 g
3170 003	2/0	20 g
3170 011	3/0	10 g
3170 012	3/0	15 g
3170 013	3/0	20 g
3170 021	4/0	10 g
3170 022	4/0	15 g
3170 023	4/0	20 g
3170 024	4/0	30 g

Trade Pack 10 Pieces



**TWITCH JIG**

Extraordinary weight head for perch specialists. The eye offset to the rear and triangular form causes the soft lure to jump aggressively to the sides and not simply in a line like customary jig heads. This will drive the fish crazy on many a day.

Code	Hook Size	Weight	Content
3107 021	2	3 g	3 pcs
3107 022	2	5 g	3 pcs
3107 023	2	7 g	3 pcs
3107 204	2/0	10 g	3 pcs
3107 205	2/0	14 g	3 pcs
3107 206	2/0	18 g	3 pcs

Trade Pack 10 Pieces

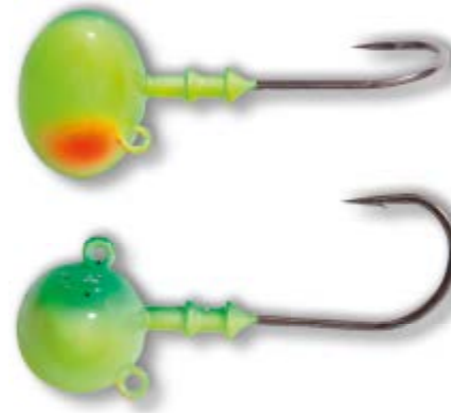

**VERTICAL HEAD**

Football vertical head with specially shortened hook shank to prevent influencing the action of the lure. The lower additional eye protects the head from bumping on the bottom while also allowing extra hooks to be attached quickly and easily. Comes in a choice of three attractive designs.

Weight	Content	Hook Size	toxic river	opening night	black
15 g	2 pcs	2/0	3115 215	3115 216	3115 217
20 g	2 pcs	2/0	3115 220	3115 221	3115 222
20 g	2 pcs	3/0	3115 320	3115 321	3115 322
30 g	2 pcs	2/0	3115 230	3115 231	3115 232
30 g	2 pcs	3/0	3115 330	3115 331	3115 332
40 g	2 pcs	3/0	3115 340	3115 341	3115 342

Trade Pack 5 Pieces



**OFFSET JIG HEAD**

Ultra-sharp offset jig hook for modern fishing between weedy banks and sunken wood.

Code	Hook Size	Weight	Content
3143 005	3/0	5 g	3 pcs
3143 007	3/0	7 g	3 pcs
3143 010	3/0	10 g	3 pcs
3143 105	4/0	5 g	3 pcs
3143 107	4/0	7 g	3 pcs
3143 110	4/0	10 g	3 pcs
3143 205	5/0	5 g	3 pcs
3143 207	5/0	7 g	3 pcs
3143 210	5/0	10 g	3 pcs

Trade Pack 5 Pieces



**UNIVERSAL DS LEAD**

Code	Weight	Content
6095 003	3,5 g	5 pcs
6095 005	5 g	5 pcs
6095 007	7 g	4 pcs
6095 010	10 g	3 pcs
6095 014	14 g	3 pcs
6095 018	18 g	3 pcs
6095 021	21 g	2 pcs
6095 028	28 g	2 pcs

Trade Pack 10 Pieces

**JIG TUNER S**

This plastic disc is rigged above the hook to send even immobile baits into a frenetic wobbling motion. Two different sizes, each in a set of three with transparent, fluorescent red and chartreuse colours.



Code	Ø	Size	Content
5103 001	18 mm	S	3 pcs
5103 002	28 mm	L	3 pcs

Trade Pack 10 Pieces



**PELAJIG**

A specially designed weight head for mid-water angling. 38g is the optimal weight for this style of fishing. The design ensures horizontal positioning in the water and is compatible with a variety of lure sizes. Available in the seven matching designs of the Quantum Pelagic Shad.



Weight	Content	Hook Size	opening night	sonar flash	game over	black pelagic	remedy	toxic river	the monk
35 g	2 pcs	4/0	3106 402	3106 408	3106 410	3106 418	3106 429	3106 403	3106 401

Trade Pack 5 Pieces







**FIREBALL SET BOX**

Contents: • Fireball 15g, 20g, 30g• Crimps 8mm, Ø 1.2mm, 20pcs• Treble Hook #6 3pcs, #8 3pcs• 10x X-Strong Dual Lock Snap 10mm• Wire Leader 2m, 8kg

**Code**  
3201 200  
Trade Pack 5 Pieces



**JIG LEAD**

Special jig leads for twister fans. These provide extra casting weight and remain immediately above the bait on the Texas and Carolina Rig due to their bell shape. Knocks against the adjacent bead to create a tempting ticking sound.

Code	Weight	Content
3158 001	3,5 g	5 pcs
3158 002	5,5 g	5 pcs
3158 003	7,5 g	3 pcs
3158 004	9,5 g	3 pcs
3158 005	11,5 g	3 pcs
3158 006	13,5 g	3 pcs
3158 007	15,5 g	2 pcs

Trade Pack 10 Pieces



**UV TORCH**

Ideal for checking the glowing properties of baits or "charging" glow-in-the-dark baits. Batteries: 3xAAA (not included).

Code	Weight
9895 005	35 g



**SEA FIREBALL**

High-quality fireball for angling with fish strips or octopus pieces. With three additional eyes, the bait itself or even additional hooks can be secured safely and easily.

Code	Hook Size	Weight	Content	Colour
3114 060	5/0	60 g	1 pcs	silver
3114 080	5/0	80 g	1 pcs	silver
3114 100	5/0	100 g	1 pcs	silver
3114 130	7/0	130 g	1 pcs	silver
3114 150	7/0	150 g	1 pcs	silver
3114 180	7/0	180 g	1 pcs	silver
3114 200	9/0	200 g	1 pcs	silver
3114 250	9/0	250 g	1 pcs	silver

Trade Pack 5 Pieces







**FOLDING BUCKET**

Practical for scooping water. With cord.

Code	Ø	Height
8401 003	23 cm	22 cm



**SEA RIG WALLET**

Rig wallet for sea anglers. Developed and tested by the Quantum Sea Team. Material: 100% Nylon

Code	Length	Width	Height
8401 040	27 cm	17 cm	4 cm

Trade Pack 5 Pieces



**WATERPROOF CARRYALL**

Multifunctional, waterproof bags in three sizes. All round zip fastening, small collapsed size. Ideal for transport of clothing, wet items in the car, various items of equipment, and of course, fish. Never do without again thanks to these highly practical bags! Our testers were thoroughly convinced. Material: Bag material: EVA film. Handle material: PP Webbing.

Code	Length	Width	Height
8401 030	40 cm	27 cm	25 cm
8401 033	55 cm	37 cm	30 cm



**DRIFT BAG L**

Drift Bag for all types of boat fishing on lakes and rivers. Either as an L version when using a "brake parachute" at the bow or stern of the boat or as a smaller design for using a drift bag at either side of the boat. Extremely robust yet easy to store design in nylon with 4 strong hangers. Each two sides of the opening are equipped with buoyancy aids and two with weights meaning the Drift Bag opens in seconds. The outflow funnel can be adjusted to the current conditions using the diameter. Material: 100% Nylon, Polyurethane coated

Code	Width	Height
8524 001	95 cm	95 cm
8524 002	62 cm	57 cm



**DRIFT BAG XXL**

Extremely effective driftbag working on a similar principle to a paraglider. Packs away to a very compact size and unfurls to its full size underwater to put the brakes on a boat like no other driftbag when drifting. Material: 100% Nylon, Polyurethane coated

Code	Width	Height
8524 003	140 cm	100 cm







**BEACH TOWER**

Quick-erect surf angling tent that impresses with its small packing dimensions and ample height when erected. Even the taller surf angler will feel at home inside. Material: 100% Nylon

Code	Width	Height	Depth	Content
9987 001	1,60 m	1,70 m	1,40 m	1 pcs

**BEACH SHELTER**

Wind and weather protection for surf anglers. Allows the angler to withstand any weather. Easy to erect and folds away just as quickly. Material: 100% Nylon

Code	Width	Height
9982 020	190 cm	149 cm



Small pack size



**WORLD CHAMPION ROD POD, EXCLUSIV**

New surf rod pod with an extra touch of class: incredibly robust with a firm footing and, naturally, corrosion-resistant. With one particularly practical feature: the front rod rests and rear rod holders are made from phosphorescent plastic. When held under a torch, these glow for hours on end helping the angler enormously when finding his/her way around in the dark.

Code	Length	Weight
8404 003	98 - 160 cm	2,6 kg



**SMOKER**

Practical smoking oven with large capacity and two burners turns your catch into a delicious meal in no time at all. Material: Stainless Steel

Code	Width	Height	Depth
9891 001	27,5 cm	11 cm	43 cm





**ADJUSTABLE PREDATOR NET**

Ultra-strong folding landing net with rubberised mesh - specially designed for space-saving transport.

Code	Length	Width	Height	Material	Tr.-Length	Mesh
7002 170	1,70 m	60 cm	70 cm	Rubber Net	1,25 m	24 x 16 mm



**PREDATOR LANDING NET**

Super-robust predator landing net with all-round metal frame. The rubberised mesh provides optimal protection for the fish and dries in no time. Available in the two most popular sizes!

Code	Length	Width	Height	Size	Material	Tr.-Length	Mesh
7003 240	2,40 m	60 cm	70 cm	XL	Rubber Net	1,05 m	24 x 16 mm
7003 255	2,55 m	80 cm	90 cm	XXL	Rubber Net	1,05 m	24 x 16 mm



**GOLIATH LANDING NET**

Ultra strong and highly robust landing net for extreme conditions, you can always count on Goliath when size matters. 6 mm mesh width.

Code	Length	Width	Depth	Mesh
7023 250	2,50 m / 70 cm	68 cm	50 cm	6 x 6 mm



**FISH MAGNET**

Incredibly strong and oversized net, also ideal for use in salt water. The rubberised mesh ensures gentle handling of the fish and prevents hooks from doing any damage. The scale on the handle is especially useful, you can measure the size of your catch immediately. You should never be without this net when you are out for the big ones!

Code	Length	Width	Height	Sections	Mesh
7019 230	1,75 - 2,30 m	80 cm	70 cm	2	15 x 8 mm



**WADING LANDING NET**

Sturdy frame, ample size and high quality finish. 8 mm mesh width.

Code	Length	Width	Height	Mesh
7000 001	51 cm	58 cm	100 cm	8 x 8 mm



**PREDATOR KEEPER**

The Predator Keeper covers a range of important functions for taking care of a landed fish: the fish can be held in it until the camera or scales have been fetched from the bag. The rubberised net prevents damage to the slime coating when the Keeper is using for weighing. The Quantum "Measure Mat Boat" is just the right size to also allow the Keeper to be used for precise measurement.



Code	Length	Width	Height	Material	Mesh
8504 010	1,30 m	30 cm	30 cm	Rubber Net	8 mm







**OUTDOOR JACKET**

The days when anglers sat at the water in second hand army clothes are over. Long sessions and inclement weather call for first class clothing. The new Quantum Outdoor clothing more than satisfies the requirements of a comfortable, contemporary design combined with modern materials and intelligently applied reinforcements. Our testers were particularly impressed with the completely wind and waterproof Water-X external material, which is breathable to prevent sweating. Watertightness: 20,000 mm water column. Material: Breathable, 100% Polyester. Gram weight: 130 g/m<sup>2</sup>

Code	Size	Colour
8902 001	M	grey/black
8902 002	L	grey/black
8902 003	XL	grey/black
8902 004	XXL	grey/black



**QUANTUM HOODY**

Material: 80% Cotton, 20% Polyester. Gram weight: 360 g/m<sup>2</sup>

Code	Size	Colour
8980 001	M	dark grey
8980 002	L	dark grey
8980 003	XL	dark grey
8980 004	XXL	dark grey
8980 005	XXXL	dark grey



**QUANTUM T-SHIRT**

Material: 100% Cotton. Gram weight: 200 g/m<sup>2</sup>

Code	Size	Colour
8981 001	M	dark grey
8981 002	L	dark grey
8981 003	XL	dark grey
8981 004	XXL	dark grey
8981 005	XXXL	dark grey



**OUTDOOR BIB'N'BRACE**

Matching bib and brace for the outdoor jacket. Material: Breathable, 100% Polyester. Gram weight: 130 g/m<sup>2</sup>

Code	Size	Colour
8901 001	M	grey/black
8901 002	L	grey/black
8901 003	XL	grey/black
8901 004	XXL	grey/black



**SPECIALIST SUNGLASSES**

Stylish sunglasses with polarised effect. An absolute must for all anglers. The sunglasses not only protect the eyes against the sun's rays, they also allow anglers to spot fish in the water that they would otherwise miss thanks to their polarised effect.

<b>Code</b>	8910 010
<b>Trade Pack</b>	3 Pieces





QUANTUM RAPPER CAP

Material: 100% Cotton



**Code** **Size** **Colour**  
 9788 074 56 cm black  
 9788 075 58 cm black  
 Trade Pack 5 Pieces

QUANTUM TRUCKER CAP

Material: 100% Cotton, Mesh 100% Polyester



**Code** **Colour**  
 9788 006 grey/white  
 Trade Pack 5 Pieces

SPECIALIST CAPS

Material: 100% Cotton. Gram weight: 340 g/m²



**Code** **Colour**  
 9788 034 black  
 Trade Pack 10 Pieces

QUANTUM VISOR

Material: 100% Cotton



**Code** **Colour**  
 9788 008 grey  
 Trade Pack 5 Pieces

**NEW**

**QUANTUM WINTER CAP**

Material: 100% Cotton

**Code** **Colour**  
 9788 070 grey  
 Trade Pack 5 Pieces

Supplied without line.

**LEADER DISPENSER BAG**

Special leader pocket with dispenser function. Not only is unwanted unwinding of expensive leader material in the bag a thing of the past, you can also pull off and cut the desired length as required. Space for five spools of leader material and compatible with our Quantum EXO FC spools or steel leader spools. Material: Polychlorid

**Code** **Ø** **Width** **Colour** **Compartments**  
 8517 043 10 cm 10 cm black/red 5

**FUJI HOOKHOLDER CLIP**

Clever accessory for retro-fitting a hook retainer to a rod. Protects the hook tip.

**Code**  
 6330 001  
 Trade Pack 5 Pieces



SPECIALIST BELLY BAG

Practical bum bag for the mobile angler with sufficient storage and high comfort. Perfect for the modern and ever-growing street fishing community. Material: 100% Nylon

**Code** **Length** **Width** **Height**  
 8517 034 22 cm 12 cm 16 cm



SPINNER BAIT BAG

Special bag for space-saving and secure storage of spin-baits or even leader materials. Material: 100% Nylon

**Code** **Length** **Width** **Height**  
 8517 019 16 cm 13,5 cm 3 cm  
 Trade Pack 5 Pieces

**SPECIALIST BAG**

Ingenious bag for the spinning angler. Made from waterproof and easy-to-clean material. Generously equipped with 1 extra-high lure box, 2 normal height lure boxes and 2 small boxes plus accessory pockets. Also ideal for boat fishing. Material: Clamps nettings. Padding: EVA. Lining material

**Code** **Width** **Height** **Depth**  
 8517 030 42 cm 30 cm 27 cm







**WATERPROOF BOXES**

Ingenious invention sought after by many an angler: waterproof boxes for small accessories and lures. With their all-round rubber O-ring and sealing clips, the boxes provide optimal protection

Code	Width	Height	Depth	Size
8061 027	22,5 cm	17,5 cm	4,7 cm	S
8061 028	27,5 cm	17,5 cm	4,7 cm	M
8061 029	35 cm	22,5 cm	4,7 cm	L

Trade Pack 10 Pieces



**STINGER BOX**

Special waterproof box for secure storage of stingers (also known as panic hooks).

Code	Length	Width	Height
8061 032	20 cm	11 cm	5 cm

Trade Pack 5 Pieces



**SPECIALIST ROD STAND**

Code	Width	Height	Depth
9963 506	60 cm	105 cm	43 cm



**CASTING PROTECTOR**

Optimal finger protection for long casts – whether surf angling or carp fishing. Material: 100% Neoprene. Gram weight: 250 g/m<sup>2</sup>

Code	Colour
9790 015	black

Trade Pack 10 Pieces



**MEASURING MAT**

A Measure Mat up to 1.3 m in length – for protective and precise measurement of fish.



Code	Length	Width
8504 001	1,30 m	15 cm

**MEASURING MAT BOAT**

A Measure Mat up to 1.3 m in length – for protective and precise measurement of fish.



Code	Length	Width
8504 002	1,30 m	30 cm



**BOWFLAG QUANTUM**

Includes flag, pole, base plate and bag.

Code	Width	Height
9966 054	60 cm	260 cm



**ROD GUARD SPINNING**

Rod protector for modern, one-piece rods during transport by car or for storage on the boat or at home. Material: 100% Polyester

Code	Length
8403 005	1,65 m
8403 006	1,65 m







**QUANTUM STICKER**

Special high-tech boat sticker with certified seawater resistance. Highly UV-resistant thanks to the use of screen printing. The UV resistance lasts several years depending on use and the intensity of the actual radiation. Material: Polychlorid adhesive film, P4 polyacrylate high-tech adhesive with certified seawater resistance

Code	Width	Height
9949 051	119 cm	45 cm



**MEASURE TAPE STICKER**

Special high-tech boat sticker with certified seawater resistance. Highly UV-resistant thanks to the use of screen printing. The UV resistance lasts several years depending on use and the intensity of the actual radiation. Material: Polychlorid adhesive film, P4 polyacrylate high-tech adhesive with certified seawater resistance

Code	Width	Height
9949 038	119 cm	12,4 cm

Trade Pack 5 Pieces



**STICKER QUANTUM**

Code	Width	Height
9949 041	21 cm	7,4 cm

Trade Pack 10 Pieces



**STICKER SET 1**

Quantum Specialist, Radical, Quantum Sea, Quantum, Fin-Nor, Zebco

Code	Width	Height
9949 027	29,7 cm	21 cm

Trade Pack 10 Pieces







**When innovation meets superior technology and excellent design in modern trout fishing, then it's all about Magic Trout! We don't get stuck on entrenched thinking patterns. Instead, we develop all our products right on the water and put our hearts and passion into every little detail.**

**Magic Trout – the modern art of trout fishing**







<b>REELS</b>	<b>MT 4</b>	<b>RODS</b>	<b>MT 6</b>	<b>ACCESSORIES</b>	<b>MT 12</b>
Pulseye	MT 4	Impulsive	MT 6	Sbirolinos	MT 12
Pulseye Pacemaker	MT 5	Pulseye	MT 6	Allround floats	MT 14
		Bloody Sword	MT 6	Disgorger & Bait Needles	MT 16
		Magic Trout Univers	MT 8	Spoon	MT 18
		Magic Trout Ease	MT 8	Floating beads	MT 20
		Magic Trout Bottom	MT 8	Twister	MT 22
		Magic Trout Superstar	MT 8	Trout Bait	MT 24
		Magic Trout X-Tase	MT 10	Fluorocarbon	MT 26
		Magic Trout Shorty „Pink Edition“	MT 10	Accessories	MT 28
		Magic Trout Shorty	MT 10		

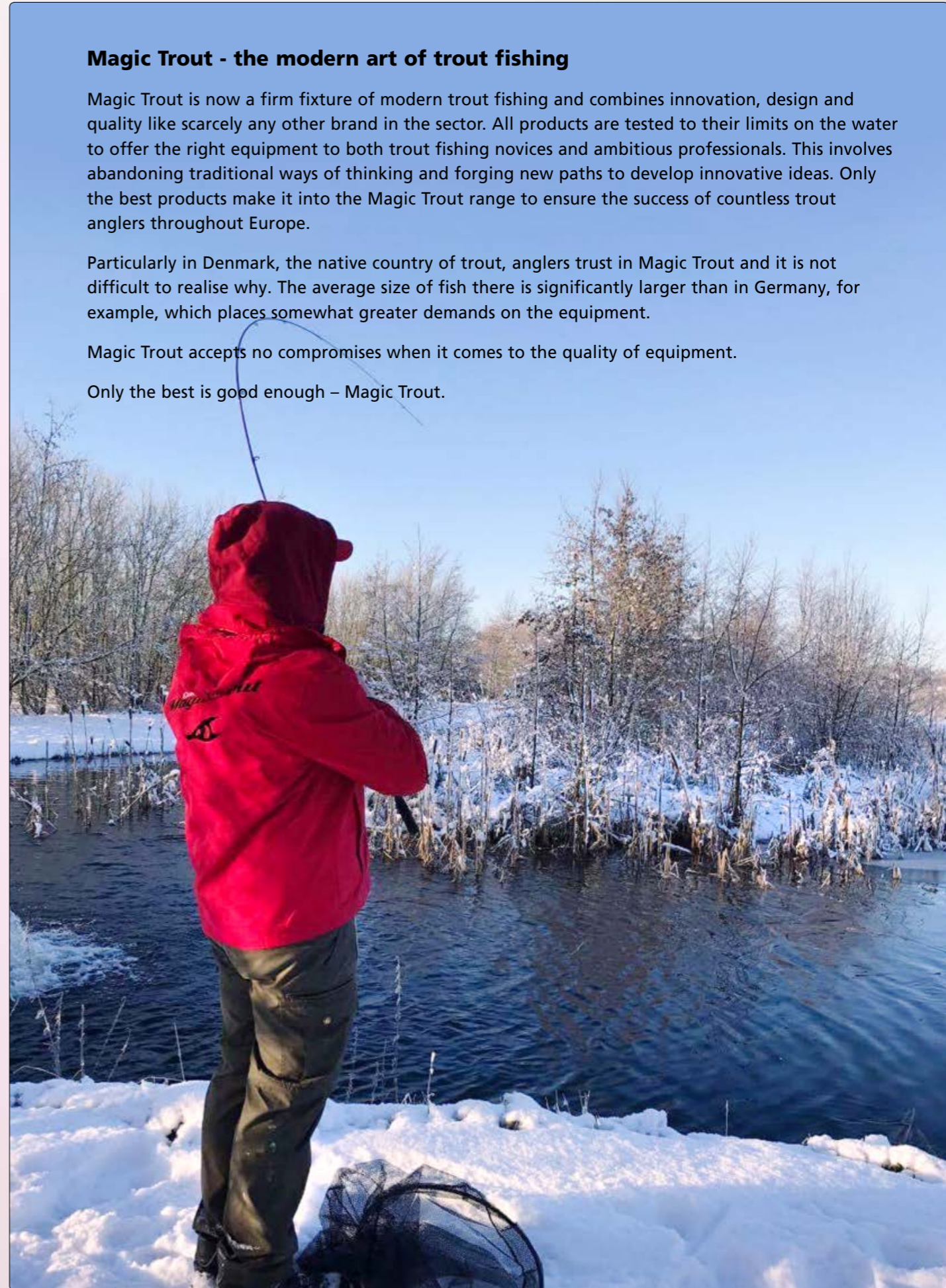

**Magic Trout - the modern art of trout fishing**

Magic Trout is now a firm fixture of modern trout fishing and combines innovation, design and quality like scarcely any other brand in the sector. All products are tested to their limits on the water to offer the right equipment to both trout fishing novices and ambitious professionals. This involves abandoning traditional ways of thinking and forging new paths to develop innovative ideas. Only the best products make it into the Magic Trout range to ensure the success of countless trout anglers throughout Europe.

Particularly in Denmark, the native country of trout, anglers trust in Magic Trout and it is not difficult to realise why. The average size of fish there is significantly larger than in Germany, for example, which places somewhat greater demands on the equipment.

Magic Trout accepts no compromises when it comes to the quality of equipment.

Only the best is good enough – Magic Trout.





- STANDARD TECHNICAL EQUIPMENT:**
- Electronically balanced lightweight rotor (LWR)
  - Housing produced in aluminium to be completely distortion-free
  - Large-surface multi-disc front drag system with carbon discs
  - Anti-twist line roller
  - Aluminium spool with hardened front edge for longer casting distances
  - S-curve line distribution



**PULSEYE**

The Pulseye series could not be without a matching reel and this model could not fit in any better. Incredible design meets phenomenal technology. No Magic Trout rod should be without this reel!



Code	Model	m / mm	Gear Ratio	Retrieve	BB	Drag F.	Weight
0359 020	1220	195 / 0,25	5,2:1	65 cm	12	2,0 kg / 4,4 lbs	235 g

Spare Spool	Model
0987 433	Sp.Spool Pulseye 1220



- STANDARD TECHNICAL EQUIPMENT:**
- Balanced rotor, producing silky smooth action
  - Housing produced in aluminium to be completely distortion-free
  - Large-surface multi-disc front drag system with carbon discs
  - Anti-twist line roller
  - Aluminium spool with hardened front edge for longer casting distances
  - S-curve line distribution
  - Rapid line retrieval



**PULSEYE PACEMAKER**

The Pulseye series could not be without a matching reel and this model could not fit in any better. Incredible design meets phenomenal technology. No Magic Trout rod should be without this reel! The Pacemaker variant offers quicker line retrieval. Ideal when you have to fish fast.



Code	Model	m / mm	Gear Ratio	Retrieve	BB	Drag F.	Weight
0359 030	1230	195 / 0,30	6,2:1	85 cm	12	5,5 kg / 12 lbs	240 g

Spare Spool	Model
0987 434	Sp.Spool Pulseye 1230 Pacemaker





NEW

Code	Model	Length	Sections	C.W.	Tr.-Length	Weight
15210 330	Impulsive	3,30 m	3	1 - 10 g	1,22 m	140 g
15210 360	Impulsive	3,60 m	3	2 - 20 g	1,28 m	165 g
15210 390	Impulsive	3,90 m	3	3 - 30 g	1,38 m	195 g

**IMPULSIVE**

The Impulsive rod series is without doubt the goddess among trout rods and a true all-round talent. As light as a feather yet with sufficient power in their locker, the Impulsive rods indicate even the most cautious bites and can steer exceptional fish above the 6 kg mark effortlessly into the landing net. These rods are worthy successors to the Pulse series and set new standards in the category.

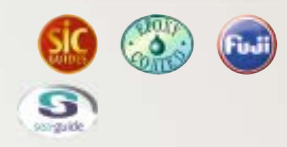

Code	Model	Length	Sections	C.W.	Tr.-Length	Weight
15200 400	One	4,00 m	7	1 - 3 g	1,05 m	125 g
15200 401	Two	4,00 m	7	2 - 4 g	1,05 m	130 g
15200 402	Three	4,00 m	7	3 - 5 g	1,05 m	135 g
15200 403	Four	4,00 m	7	4 - 6 g	1,05 m	140 g

**PULSEYE**

The Pulseye sets completely new standards in tremarella rods! Anybody familiar with Italian quiver fishing will love this rod and never want to put it down!



NEW

Code	Model	Length	Sections	C.W.	Tr.-Length	Weight
15215 200	Bloody Sword	2,00 m	2	0,5 - 6 g	1,05 m	100 g
15215 220	Bloody Sword	2,20 m	2	1 - 8 g	1,13 m	105 g

**BLOODY SWORD**

Ultra-light fishing with the smallest spinners are highly popular on trout lakes at the moment and the Bloody-sword has been designed precisely for this application. The rod catapults light weights effortlessly and precisely to hotspots and boldly does battle with even monster specimens. UL and Bloodysword, a perfect and lethal combination for all salmonids.

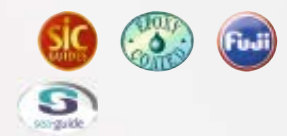





Code	Model	Length	Sections	C.W.	Tr.-Length	Weight
1494 330	Magic Trout Univers	3,30 m	3	5 - 20 g	1,19 m	233 g
1494 360	Magic Trout Univers	3,60 m	3	5 - 30 g	1,29 m	254 g
1494 390	Magic Trout Univers	3,90 m	3	10 - 40 g	1,39 m	325 g

**MAGIC TROUT UNIVERS**  
 Fishing with a sbirolino is the key to success on many a trout lake. In the Magic Trout Univers, we present the optimal rod for achieving large casting distances while still being able to detect even cautious twitches. However, the all-rounder can also fish fantastically with other weights. The Magic Trout Univers is a rod that should absolutely be in every trout angler's holdall!



Code	Model	Length	Sections	C.W.	Tr.-Length	Weight
1495 380	Magic Trout Ease	3,80 m	7	15 g	1,22 m	160 g
1495 400	Magic Trout Ease	4,00 m	7	25 g	1,25 m	185 g

**MAGIC TROUT EASE**  
 Once you have fished with this dream telescopic rod, you will not want to put it down. The rod is feather-light with a fantastic semi-parabolic action and seamlessly covers all aspects of moderate trout fishing. Thanks to its design, it can also be easily transported in rod stands.



Code	Model	Length	Sections	C.W.	Tr.-Length	F. Tips	Weight	Code	Model	provided Feeder Tips
1492 330	Magic Trout Bottom	3,30 m	3	12 - 25 g	1,15 m	2	338 g	1492 330	Magic Trout Bottom	12g, 25g

**MAGIC TROUT BOTTOM**  
 The Magic Trout Bottom is the perfect partner when retrieving lures "from the bottom up". The sensitive interchangeable tips in two different degrees of rigidity indicate even the most sensitive bites over long distances. A special bonus feature is the additional third interchangeable tip with large rings. The passive method of presenting a rising bait off the bottom is particularly successful in winter. However, ice can often scupper such plans. The Magic Trout Bottom offers the perfect solution!



Code	Model	Length	Sections	C.W.	Tr.-Length	Weight
15202 400	1	3,80 m	8	0 - 2 g	1,03 m	160 g
15202 401	2	3,80 m	8	1 - 3 g	1,03 m	160 g
15202 402	3	3,80 m	8	2 - 5 g	1,03 m	160 g
15202 403	4	3,80 m	8	3 - 8 g	1,03 m	160 g

**MAGIC TROUT SUPERSTAR**  
 A tremarella rod in the lower price segment that delivers super performance. Impossible, right? The Magic Trout Superstar clearly proves otherwise and demonstrates that good quality is also affordable on a modest budget.



kompletný cenník na [www.SPORTS.sk](http://www.SPORTS.sk), výhradný distribútor pre SR: SPORTS s.r.o.





Code	Model	Length	Sections	C.W.	Tr.-Length	Weight
15201 400	10	4,00 m	8	3 - 10 g	1,29 m	135 g
15201 401	15	4,00 m	8	5 - 15 g	1,29 m	140 g
15201 402	20	4,00 m	8	10 - 20 g	1,29 m	160 g
15201 403	30	4,00 m	8	15 - 30 g	1,29 m	165 g

**MAGIC TROUT X-TASE**  
 This all-round telescopic rod has caused a veritable sensation in the trout scene. The rods are completely at home in all aspects of trout fishing and should be a fixture on every rod stand.



Code	Model	Length	Sections	C.W.	Tr.-Length	Weight
1493 271	Magic Trout Shorty "Pink Edition"	2,70 m	2	1 - 3 g	1,39 m	114 g

**MAGIC TROUT SHORTY "PINK EDITION"**  
 On small fisheries, long tremarella rods can be too much of a good thing. This is where the Magic Trout Shorty comes into its own. The rod is the ideal plaything when there are no long casting distances involved and light weights are called for. The sensitive blank transfers vibrations perfectly to the lure and makes for incredible fun during a fight! The Magic Trout Shorty - a rod for addictive fun!



Code	Model	Length	Sections	C.W.	Tr.-Length	Weight
1493 270	Magic Trout Shorty	2,70 m	2	1 - 3 g	1,39 m	114 g
1493 300	Magic Trout Shorty	3,00 m	2	2 - 6 g	1,55 m	137 g

**MAGIC TROUT SHORTY**  
 On small fisheries, long tremarella rods can be too much of a good thing. This is where the Magic Trout Shorty comes into its own. The rod is the ideal plaything when there are no long casting distances involved and light weights are called for. The sensitive blank transfers vibrations perfectly to the lure and makes for incredible fun during a fight! The Magic Trout Shorty - a rod for addictive fun!







**MAGIC TROUT WARPLANE**

The Warplane Sbirolino lives up to its name: No other Sbirolino flies in such a straight line or as far as this precisely-balanced missile. The three different sinking modes cover the entire spectrum for trout lake fishing and are easily recognisable by their colour coding.

Code	Weight	Colour	Action
5200 008	8 g	blue	slow sinking
5200 010	10 g	blue	slow sinking
5200 012	12 g	blue	slow sinking
5200 015	15 g	blue	slow sinking
5200 020	20 g	blue	slow sinking
5200 025	25 g	blue	slow sinking

Trade Pack 10 Pieces



**MAGIC TROUT WARPLANE**

The Warplane Sbirolino lives up to its name: No other Sbirolino flies in such a straight line or as far as this precisely-balanced missile. The three different sinking modes cover the entire spectrum for trout lake fishing and are easily recognisable by their colour coding.

Code	Weight	Colour	Action
5200 108	8 g	green	sinking
5200 110	10 g	green	sinking
5200 115	15 g	green	sinking
5200 120	20 g	green	sinking
5200 125	25 g	green	sinking

Trade Pack 10 Pieces



**MAGIC TROUT WARPLANE**

The Warplane Sbirolino lives up to its name: No other Sbirolino flies in such a straight line or as far as this precisely-balanced missile. The three different sinking modes cover the entire spectrum for trout lake fishing and are easily recognisable by their colour coding.

Code	Weight	Colour	Action
5200 208	8 g	black	fast sinking
5200 210	10 g	black	fast sinking
5200 212	12 g	black	fast sinking
5200 220	20 g	black	fast sinking

Trade Pack 10 Pieces



**ULTRASONIC TREMARELLA RATTLE FLOAT**

The Magic Trout Ultrasonic Tremarella-La Rattle Float offers no shortage of attraction, with a small rattle integrated into the popper float. No trout can resist the combination of the noise from the rattle and the vibrations and pressure waves from the float.

Code	BS	Colour
5311 002	2 g	white
5311 003	3 g	white
5311 004	4 g	white

Trade Pack 10 Pieces



**ULTRASONIC BLACK TIP FLOAT**

Regular floats are not easily visible under backlight conditions. The Black Tip is our ingenious solution to this problem. Its long tip, which protrudes far above the water, and its sensitive body design ensure that you will never miss a bite.

Code	Ø Elastic	BS	Colour
5320 002	12/14 mm	2 g	white
5320 003	12/14 mm	3 g	white
5320 004	12/14 mm	4 g	white

Trade Pack 10 Pieces



Real Balsa Wood

**ULTRASONIC TRICK STICK FLOAT**

Outstanding version of the tried and trusted quill. The special design practically eliminates line tangles that frequently occur with normal quills.

Code	BS	Colour
5317 002	2 g	white
5317 003	3 g	white
5317 004	4 g	white

Trade Pack 10 Pieces



**ULTRASONIC TROLLING FLOAT**

The float design is particularly suited to trolling. The large tip provides excellent visibility and reliably indicates every bite even in poor visibility.

Code	BS	Colour
5313 002	2 g	white
5313 003	3 g	white
5313 004	4 g	white
5313 005	5 g	white

Trade Pack 10 Pieces



**ULTRASONIC SENSITIVE FLOAT**

Some days, the trout bite particularly cautiously. This is where the Ultrasonic Sensitive Float comes into its own. The special design ensures that the fish feel little resistance when biting.

Code	BS	Colour
5312 002	2 g	white
5312 003	3 g	white
5312 004	4 g	white

Trade Pack 10 Pieces



**ULTRASONIC TREMARELLA FLOAT**

The Magic Trout Ultrasonic Tremarella Float is indispensable in modern trout fishing, combining with the tremarella system to attract even lethargic trout to the bait via vibrations and pressure waves on the surface.

Code	BS	Colour
5316 002	2 g	white
5316 003	3 g	white
5316 004	4 g	white

Trade Pack 10 Pieces



**ULTRASONIC BOMBARDE**

Innovative floating sbirolino. The coloured surface faces upwards when fishing, allowing the angler to follow every bite even at long range.

Code	Weight	Colour
5310 010	10 g	white
5310 015	15 g	white
5310 020	20 g	white
5310 025	25 g	white

Trade Pack 10 Pieces



**ULTRASONIC LIFTER**

If the trout are located far away, the key word is "Ultrasonic Lifter Float". The lifter float can travel large distances effortlessly and is easily identifiable by its signal antenna.

Code	Weight	Colour
5319 005	5 g	white
5319 010	10 g	white
5319 015	15 g	white
5319 020	20 g	white
5319 025	25 g	white

Trade Pack 10 Pieces



**ULTRASONIC BULLET**

The Magic Trout Ultrasonic Bullet Float is already pre-weighted, making it perfect for presenting a bait extremely slowly and close to the surface using the tremarella system. An absolute MUST when the fish are close to the surface.

Code	Weight	Colour
5315 004	4 g	white
5315 006	6 g	white
5315 008	8 g	white

Trade Pack 10 Pieces





**NEW**  
**LEAD FREE**

**ULTRASONIC NIGHT CATCHER**  
Float for fixed-spool fishing that can also be used with a snaplight when night fishing. Also ideally suited for a rig with a pilot ball.

Code	Weight	Colour
5318 004	4 g	white
5318 008	8 g	white
5318 012	12 g	white

Trade Pack 10 Pieces

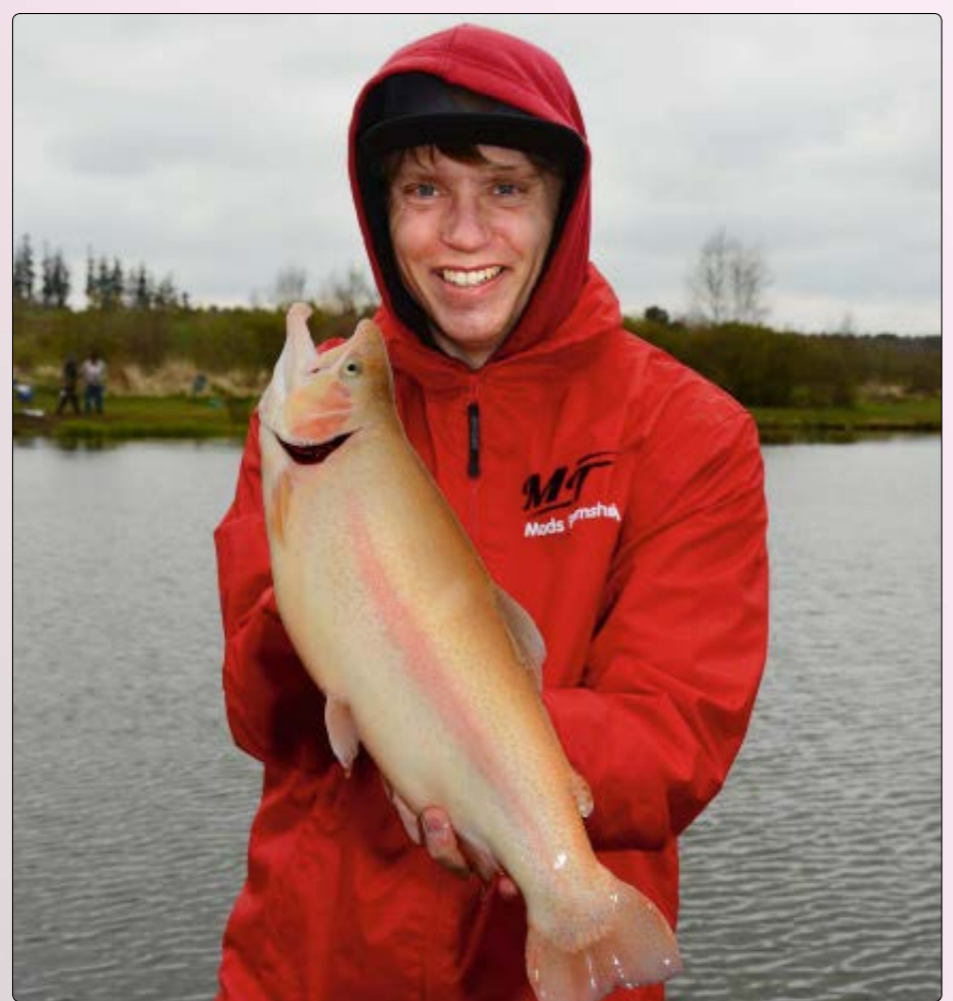

**SMART SBIRO**  
Excellent value for money sbirulinos, in conventional design and three different sinking speeds.

Code	Weight	Colour	Action
5100 110	10 g	white	suspender
5100 115	15 g	white	suspender
5100 120	20 g	white	suspender
5100 125	25 g	white	suspender
5100 130	30 g	white	suspender

Trade Pack 10 Pieces



**SMART SBIRO**  
Excellent value for money sbirulinos, in conventional design and three different sinking speeds.

Code	Weight	Colour	Action
5100 210	10 g	clear	sinking
5100 215	15 g	clear	sinking
5100 220	20 g	clear	sinking
5100 225	25 g	clear	sinking
5100 230	30 g	clear	sinking

Trade Pack 10 Pieces



**SMART SBIRO**  
Excellent value for money sbirulinos, in conventional design and three different sinking speeds.

Code	Weight	Colour	Action
5100 010	10 g	green	floating
5100 015	15 g	green	floating
5100 020	20 g	green	floating
5100 025	25 g	green	floating
5100 030	30 g	green	floating
5100 040	40 g	green	floating

Trade Pack 10 Pieces



**NEW**

**MAGIC TROUT PILOT**  
Magic Trout Pilots are the next stage in the evolution of standard pilot balls. Fixed to the line with silicon sleeves, these practical little helpers can be used again and again. Tangles in the leader are now a thing of the past!

Length	Content	red	yellow	white
17 mm	5 pcs	5299 001	5299 101	5299 201
25 mm	5 pcs	5299 002	5299 102	5299 202

Trade Pack 10 Pieces

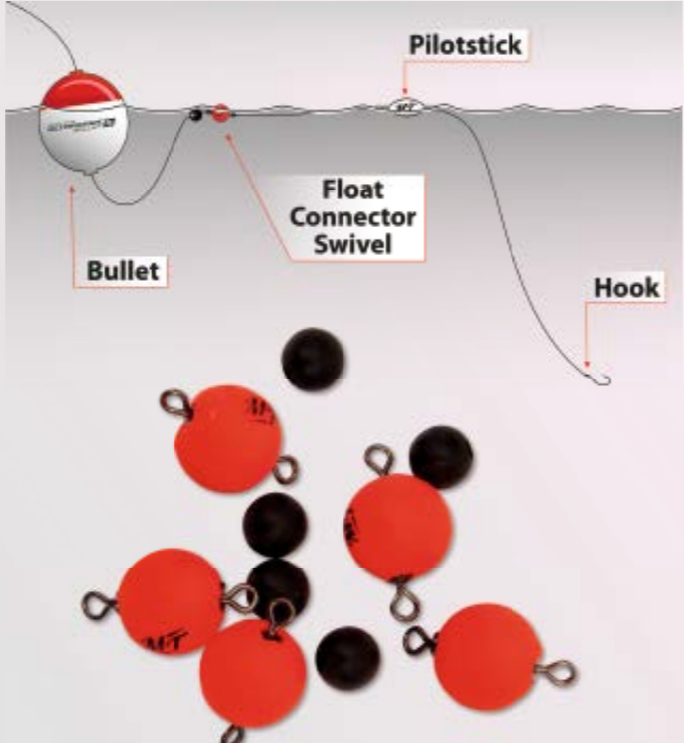

**FLOAT CONNECTOR SWIVEL**  
A frequent problem is that the swivel behind the float or the floating sbirolino sinks. The innovative Float Connector Swivel is the optimal solution since the swivel is directly integrated with a pilot.

Code	Ø	Size	BS	Content	Colour
6159 000	10 mm	10	14 kg	5 pcs	red

Trade Pack 10 Pieces



**MULTI-FUNCTION SBIROLINO**  
Can be filled with water to adapt to different fishing conditions.

Code	Weight
5102 014	14 g

Trade Pack 10 Pieces



**MAGIC TROUT SURFACE RATTLE**  
Now and again, you really have to shake the trout up. Our surface rattle with integrated beads creates a real racket and acts like a magnet for trout. On those difficult days, the Magic Trout Surface Rattle is often the key.

Code	Weight
5216 001	4 g
5216 002	6 g
5216 003	8 g
5216 004	12 g

Trade Pack 10 Pieces



**SMART SBIRO DISPLAY**  
100 Smart Sbiros in a counter display.

Code	Content
5100 999	100 pcs

kompletný cenník na [www.SPORTS.sk](http://www.SPORTS.sk), výhradný distribútor pre SR: SPORTS s.r.o.





**GHOST TUBES SHORT, FAST SINKING**

Magic Trout Ghost Tubes are indispensable in modern trout fishing. The transparent glass casting weight is ideal for casting light floats over long distances thanks to its specific density in the water. However, these Ghost Tubes can also be fished alone.

Code	Weight	Content
5221 004	4 g	5 pcs
5221 005	5 g	5 pcs
5221 006	6 g	5 pcs
5221 007	7 g	5 pcs
5221 008	8 g	5 pcs
5221 010	10 g	4 pcs

Trade Pack 5 Pieces



**GHOST TUBES SLIM, SLOW SINKING**

Magic Trout Ghost Tubes are indispensable in modern trout fishing. The transparent glass casting weight is ideal for casting light floats over long distances thanks to its specific density in the water. However, these Ghost Tubes can also be fished alone.

Code	Weight	Content
5222 004	4 g	5 pcs
5222 005	5 g	5 pcs
5222 006	6 g	5 pcs
5222 007	7 g	5 pcs
5222 008	8 g	5 pcs

Trade Pack 5 Pieces



**CLICKCLACKGLASS**

An ingenious product ideally suited to use with the tremarella technique. Placing glass against glass creates an acoustic attraction that enchants the trout out of the lake.

Code	Weight	Content
5225 004	4 g	3 pcs
5225 005	5 g	3 pcs
5225 006	6 g	3 pcs
5225 007	7 g	3 pcs
5225 008	8 g	3 pcs

Trade Pack 5 Pieces



**SONAR GLASS CHAIN**

This chain of glass tubes and springs is particularly effective when fishing near the surface. The special sinking behaviour allows bites to be converted significantly more easily, with the noise created by the springs touching the glass creating additional attraction.

Code	Weight	Content
5223 001	2 g	1 pcs
5223 002	3 g	1 pcs
5223 003	4 g	1 pcs

Trade Pack 5 Pieces



**NEW**

**MAGIC TROUT POWER STOPPER OVAL**

High quality stopper in two designs. The oval version is ideal for protecting knots, for example, when using strings of glass or lead sinkers.

Code	Size	Content
3155 013	S	10 pcs
3155 014	M	10 pcs
3155 015	L	10 pcs
3155 016	LL	10 pcs

Trade Pack 10 Pieces



**NEW**

**MAGIC TROUT POWER STOPPER SQUARE**

High quality stopper in two designs. The elongated version is more suited to attaching leads or glass sinkers.

Code	Size	Content
3155 023	S	10 pcs
3155 024	M	10 pcs
3155 025	L	10 pcs
3155 026	LL	10 pcs

Trade Pack 10 Pieces



**MAGIC TROUT HOOK REMOVER**

The Magic Trout Hook Remover is a particularly practical hook removal tool. The remover slides through the guide to the hook almost by itself. Now hook removal can be a piece of cake!

Code	Size	Colour
6321 001	S	red

Trade Pack 10 Pieces



**MAGIC TROUT HOOK REMOVER**

The Magic Trout Hook Remover is a particularly practical hook removal tool. The remover slides through the guide to the hook almost by itself. Now hook removal can be a piece of cake!

Code	Size	Colour
6321 003	L	red

Trade Pack 10 Pieces



**MAGIC TROUT SBIRO THREADER**

When dry, threading line to a Sbirolino can be a little fiddly. And if the Sbirolino is already wet, threading is almost impossible. The Magic Trout Sbiro Threader is the perfect assistant.

Code	Length
6604 001	22 cm

Trade Pack 10 Pieces



**MULTIFUNCTION TOOL**

Practical aid for caring for fish. Everything the angler needs combined in a single tool!

Code	Colour
6321 005	red



**BAIT PUNCH**

The Magic Trout Bait Punch is a special cutter for paste platelets and an indispensable tool especially for trout experts.

Code	Ø
6321 000	15 mm

Trade Pack 5 Pieces







**BLOODY SPOON**

Small spoons are now indispensable on trout lakes. The extraordinary action of the Bloody Spoon combined with its ultra-attractive colours make it a secret weapon on any trout lake.

Size	Weight	red/yellow	silver/green	yellow/green	black/white	copper/black	pink/white	silver/blue	pearl yellow
2	3,5 g	3363 001	3363 002	3363 003	3363 004	3363 005	3363 006	3363 007	3363 008

Trade Pack 10 Pieces



**BLOODY BLADES**

Small-blade spoon for active fishing with UL tackle or behind a sbirolino. Thanks to its low weight, it flies superbly behind the sbirolino and plummets enticingly in slow motion during the sinking phase. This striking bait movement is irresistible to all salmonid species!

Size	Weight	red/yellow	silver/green	yellow/green	black/white	copper/black	pink/white	silver/blue	pearl yellow
2	2,1 g	3362 001	3362 002	3362 003	3362 004	3362 005	3362 006	3362 007	3362 008

Trade Pack 10 Pieces



**BLOODY UL SPINNER**

The rotation of the spinner blade is the key to success. Follow various tests on the design and the arrangement of the beads on the shaft, it was clear that the lure had to behave just like the Bloody UL spinner in the water. The ultra-sharp treble hooks complete the package perfectly and the outstanding catches in subsequent testing were inevitable.

Size	Weight	Content	red/yellow	silver/green	yellow/green	black/white	copper/black	pink/white	silver/blue	pearl yellow
1	1,75 g	1 pcs	3340 001	3340 002	3340 003	3340 004	3340 005	3340 006	3340 007	3340 008

Trade Pack 10 Pieces



kompeľný cenník na [www.SPORTS.sk](http://www.SPORTS.sk), výhradný distribútor pre SR: SPORTS s.r.o.





**BLOODY INLINER**

The Bloody Inliner represents the pinnacle of inline lures. With its slender design, the lure can be used in a variety of ways at all depths of water and drives trout into an attacking frenzy whether twitched or retrieved at a constant rate.

Size	Weight	red/yellow	silver/green	yellow/green	black/white	copper/black	pink/white	silver/blue	pearl yellow
1	4 g	3360 001	3360 002	3360 003	3360 004	3360 005	3360 006	3360 007	3360 008

Trade Pack 10 Pieces



**FAT BLOODY INLINER**

The big brother of the Bloody Inliner particularly comes into its own with slow retrieve speeds and during the sinking phase. You rarely have to wait long for a bite with the Fat Bloody Inliner.

Size	Weight	red/yellow	silver/green	yellow/green	black/white	copper/black	pink/white	silver/blue	pearl yellow
2	8 g	3361 001	3361 002	3361 003	3361 004	3361 005	3361 006	3361 007	3361 008

Trade Pack 10 Pieces

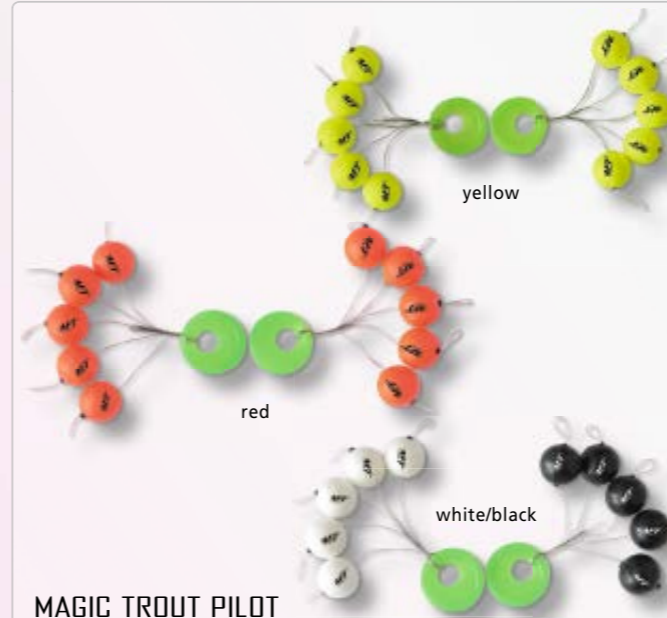

**MAGIC TROUT PILOT**

Our pilots with integrated stoppers are highly versatile. The bright colours are also the perfect choice when bites are cautious, providing an additional bite indicator between bait and trolling float. In addition, the pilots allow the sinking depth of the bait to be varied. Even the inconspicuous version acts as a buoyancy aid when fishing off the bottom and should be a fixture in every tackle box.

Length	Content	yellow	red	white/black
6 mm	10 pcs	3188 001	3188 101	3188 201
8 mm	10 pcs	3188 002	3188 102	3188 202
10 mm	10 pcs	3188 003	3188 103	3188 203
12 mm	10 pcs	3188 004	3188 104	3188 204

Trade Pack 10 Pieces



**MORMYSCHKA SET**

Classic lure set that always has the right lure, particularly for ice fishing.

Code	Colour	Content	Hook Size
6099 100	black/red/yellow	9 pcs	10

Trade Pack 10 Pieces



**SLIDE SINKER**

The adjustable weights can be attached to the line easily without causing damage.

Code	Colour	Content	Weight
6099 005	black	5 pcs	0,5 g

Trade Pack 10 Pieces



**MAGIC TROUT SWIVEL**

Code	Length	Content	Size	BS
6117 010	25 mm	10 pcs	10	10 kg
6117 012	22 mm	10 pcs	12	7 kg

Trade Pack 10 Pieces



**TREBLE SWIVEL. HIGH SPEED**

Code	Length	Content	Size	BS
6132 008	17 mm	7 pcs	8	20 kg
6132 010	15 mm	10 pcs	10	14 kg
6132 012	13 mm	10 pcs	12	9 kg
6132 014	11 mm	10 pcs	14	5 kg

Trade Pack 10 Pieces





**MAGIC TROUT B-MAGGOT**

Bee larvae are one of the most popular and successful baits on trout lakes. It is just a shame these are not always to hand. Our artificial bee maggots owe nothing to their natural equivalents in terms of attraction and stay on the hook much more easily. The longitudinal division of the colours creates an irresistible on-off effect in the B Maggots. Magic Trout B-Maggots – a true ace up your sleeve!

Length	Content	Action	natural	black/yellow	black/red	black/white	yellow/orange	green/white	white/blue	yellow/green	white/red	glow in the dark
2,5 cm	35 pcs	floating	3211 001	3211 002	3211 003	3211 004	3211 005	3211 006	3211 007	3211 008	3211 009	3211 010

Trade Pack 10 Pieces



**CURLY B-BOBBLES**

The Curly B-Bobbles are quite unique twisters. The twisters can be fished with or without bobbles on the twister tail to create different motion patterns. If the tail suffers bite damage, it can be removed and you are left with our popular artificial bee larva. 3 in 1 - simply ingenious!

Length	Weight	Content	Garlic natural	Garlic black/yellow	Garlic black/red	Garlic black/white	Garlic yellow/orange	Garlic green/white	Garlic blue/white	Garlic yellow/green	Garlic red/white	Garlic self-luminous
3,5 cm	0,4 g	35 pcs	3261 001	3261 002	3261 003	3261 004	3261 005	3261 006	3261 007	3261 008	3261 009	3261 010
4,2 cm	1,1 g	35 pcs	3261 101	3261 102	3261 103	3261 104	3261 105	3261 106	3261 107	3261 108	3261 109	3261 110

Trade Pack 10 Pieces

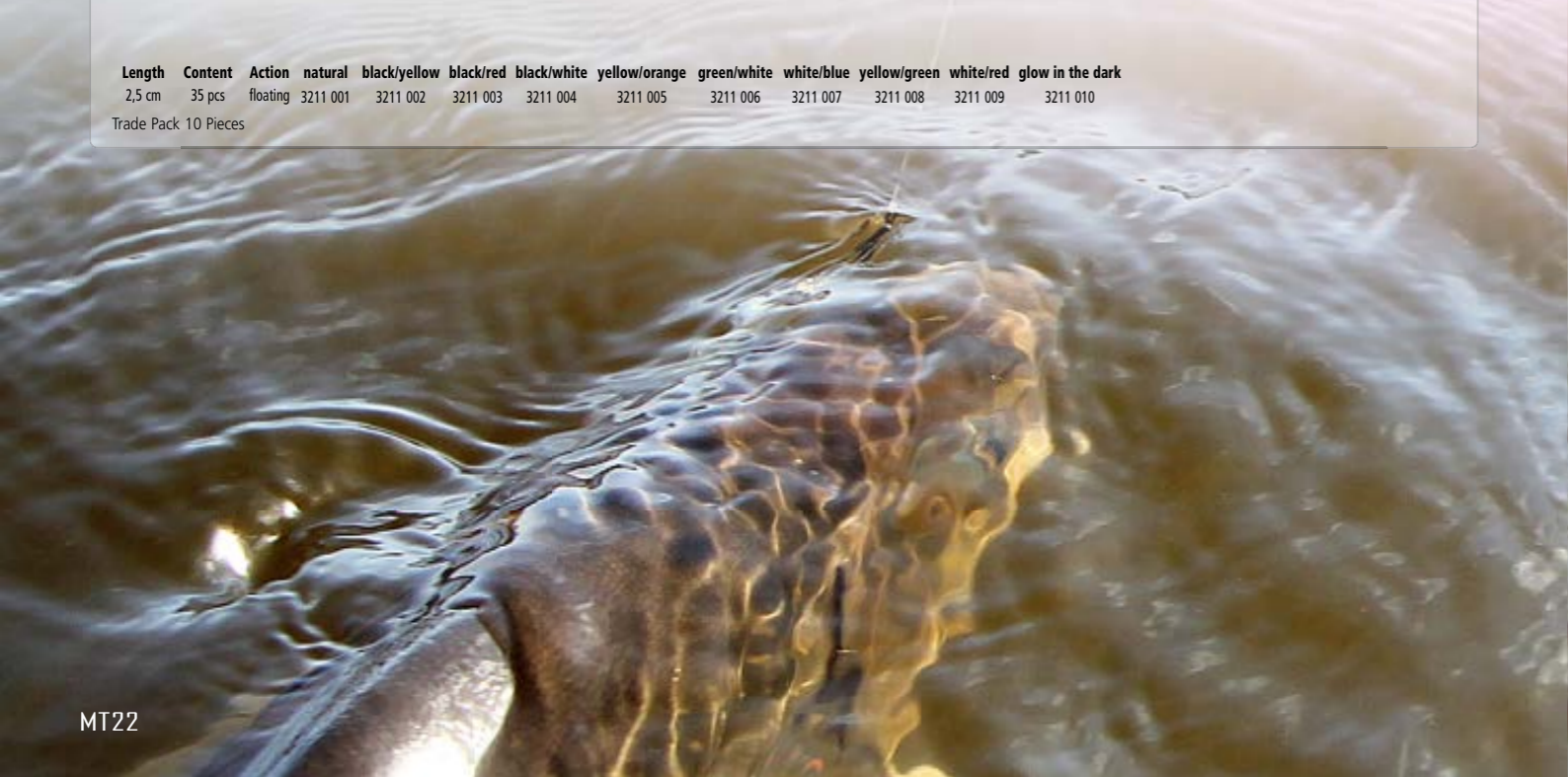





Garlic / red      Garlic / black      Garlic / yellow      Garlic / white



Garlic / blue      Garlic / green      Garlic / brown      Garlic / orange

TROUT BAIT

Perfect malleability, extremely attractive aroma and the right colours. This was the principle behind the development of the new Magic Trout Paste. And what can we say? It does not get any better than Magic Trout Paste!

Contents	Action	Garlic red	Garlic black	Garlic yellow	Garlic white	Garlic blue	Garlic green	Garlic brown	Garlic orange
50 g	floating	3983 001	3983 002	3983 003	3983 004	3983 005	3983 006	3983 007	3983 008

Trade Pack 6 Pieces



TROUT BAIT TASTE

A knock-out aroma with the x factor! Lakritz proved extremely effective during testing and tempts trout out of their lairs even when using passive fishing methods.

Code	Colour	Contents	Flavour	Action
3986 010	black	50 g	Liquorice	floating

Trade Pack 6 Pieces



TROUT BAIT TASTE

Trout like it sweet! After the miracle Erdbeer aroma, we now introduce the next sweet temptation in the Magic Trout Bait range, which is sure to cause a sensation.

Code	Colour	Contents	Flavour	Action
3987 011	red/white	50 g	Candy	floating

Trade Pack 6 Pieces



TROUT BAIT TASTE

Perfect malleability, extremely attractive aroma and the right colours. This was the principle behind the development of the new Magic Trout Paste. And what can we say? It does not get any better than Magic Trout Paste!

Code	Colour	Contents	Flavour	Action
3984 001	pink/red	50 g	Strawberry	floating

Trade Pack 6 Pieces



TROUT BAIT TASTE

Perfect malleability, extremely attractive aroma and the right colours. This was the principle behind the development of the new Magic Trout Paste. And what can we say? It does not get any better than Magic Trout Paste!

Code	Colour	Contents	Flavour	Action
3985 009	chartreuse	50 g	Cheese	floating

Trade Pack 6 Pieces



**NEW**

TROUT BAIT TASTE

A classic from the shore – the shrimp. This aroma is also such a game changer on trout lakes, our test anglers were crestfallen when the first test batch ran out. A must in every tackle box!

Code	Colour	Contents	Flavour	Action
3988 012	pink	50 g	Crabby	floating

Trade Pack 6 Pieces



MAGIC TROUT DISPLAY

Sales Counter Cardboard Display for 30 jars in five rows. Improves sales through higher visibility. Easy to assemble.

Code	3982 999
------	----------



**SPECIALIST TROUT BAG**

Anglers heading to the trout lake often don't need an abundance of accessories. A few jars of paste, a handful of Sbirolinos, small accessories and the necessary equipment to care for the fish will generally suffice. Our Specialist Trout Bag can comfortably accommodate all of that and even has its own special compartments for paste and Sbirolinos. Now nothing should go missing. Material: 100% Nylon



Code	Width	Height	Depth
8517 031	38 cm	23 cm	24 cm



**MAGIC TROUT MONSTER CARRIER XXL**

The Magic Trout Monster Carrier XXL transports absolutely everything to the water. Use in conjunction with the Zebco Fish Bucket to take full advantage of its features. Landed fish can simply slide through the small hatch in the bucket without having to open the entire bag. Besides the bucket, the monster bag can also carry at least 4 large boxes and 2 small boxes. The front pocket can store paste jars while the small pockets are designed for leader material and rig winders. Fish, tackle, baits, accessories – the Monster Carrier XXL swallows it all effortlessly! Comes without bucket, boxes and accessories. Material: Polychlorid

Code	Length	Height
8517 044	38 cm / 54 cm	30 cm



**SBIRULINO CASE**

Every trout angler takes them to the water's edge – sbirolinos, trolling floats and a variety of other floats. Unfortunately, these are often damaged during transport. No longer with the Magic Trout sbirolino case. The case provides ample storage and keeps the contents safe. Material: 100% Nylon

Code	Length	Width	Height
8517 033	34 cm	26 cm	7,5 cm



**ROD PROTECTOR**

Inflatable protector, specially designed for delicate tremarella or Bolognese rods during transport. Material: Polychlorid

Code	Length
8517 041	30 cm



**MT FLUOROCARBON**

Leader material with optimal properties in terms of knot strength, smoothness and durability. A must-have for any angler who ties his own hooklengths.

Code	Ø	Length	BS	Colour
2600 016	0,16 mm	50 m	1,68 kg	clear
2600 018	0,18 mm	50 m	2,57 kg	clear
2600 020	0,20 mm	50 m	3,08 kg	clear
2600 022	0,22 mm	50 m	3,53 kg	clear

Trade Pack 5 Pieces



**B-MAGGOT RIGGED HOOKS**

These tied leader hooks have been specially developed for fishing with bee larvae. Thin-wired yet strong!

Code	Ø	Hook Size	Hooklength	Content	Colour
4730 004	0,18 mm	4	70 cm	10 pcs	red
4730 006	0,18 mm	6	70 cm	10 pcs	red
4730 008	0,16 mm	8	70 cm	10 pcs	red
4730 104	0,18 mm	4	180 cm	10 pcs	red
4730 106	0,18 mm	6	180 cm	10 pcs	red
4730 108	0,16 mm	8	180 cm	10 pcs	red

Trade Pack 10 Pieces



**TROUT RIGGED SLOW DEATH HOOKS**

This hook design allows any bait to rotate effortlessly. Now also available as tied leader hooks.

Code	Ø	Hook Size	Hooklength	Content	Colour
4714 006	0,18 mm	6	70 cm	5 pcs	red
4714 106	0,18 mm	6	180 cm	5 pcs	red
4715 006	0,20 mm	6	70 cm	5 pcs	red
4715 106	0,20 mm	6	180 cm	5 pcs	red

Trade Pack 10 Pieces



**MAGIC TROUT PROPELLER RIG**

These rigs are specially tailored to trout lake fishing and offer no shortage of attraction. Absolutely any of these rigs will provide magic moments in a day at the trout lake – no trout can resist them!

Code	Length	Colour	Content	Ø	Hook Size
4220 009	2 m	silver	2 pcs	0,20 mm	6
4220 010	2 m	silver	2 pcs	0,20 mm	10

Trade Pack 5 Pieces







## PULYSEYE EYECATCHER

Perfect, ultra-light landing net handle for use on trout lakes. The Trout Scooper Handle is even stable enough for large trout!

Code	Width	Sections
7105 300	3,00 m	3



## TROUT SCOOPER HEAD

Small details often make the difference. In this carbon landing net, the trout lies in just the right position to take it out while the net does not absorb any odours. The super-light landing net to match the Magic Trout Scooper Handle.

Code	Length	Width	Depth
7006 001	40 cm	40 cm	30 cm







### MAGIC TROUT STICKER

Code	Ø
9949 072	95 mm

Trade Pack 10 Pieces



### MAGIC TROUT TRUCKER CAP

Material: 100% Cotton, Mesh 100% Polyester



Code	Colour
9788 011	red/white

Trade Pack 5 Pieces





# BLACK CAT



*Designed by  
Stefan Seuß*

**Catfish angling – an extreme adventure that calls for extraordinary equipment. The 'Black Cat' collection by renowned Stefan Seuß delivers everything you could wish for in this hardcore pursuit and has been tested against the toughest opponents swimming in Europe's rivers.**





**REELS**

- Black Cat Extreme FD BC 3
- Battle Cat Spin FD BC 4
- Black Cat Shadow Spin FD BC 5
- Passion Pro FD BC 6
- Black Cat Long Ranger BC 7
- Black Cat Buster BC 8
- BC<sup>2</sup> BC 9

**RODS**

- The Pellet BC 10-11
- Solid Fun BC 10-11
- Fireball II BC 12-13
- Vertical LS II BC 12-13
- Fun Stick Collector II BC 12-13
- Spin Mix BC 12-13
- Verticalmania J/C BC 12-13
- Freestyle BC 14-15
- Freestyle Boat BC 14-15
- Wild Cat'z BC 14-15
- Battle Cat Fun BC 16-17
- Battle Cat Spin BC 16-17
- Battle Cat V-Twist BC 16-17
- Battle Cat Multi Style BC 16-17
- Battle Cat Vertical BC 18-19
- Battle Cat Boat BC 18-19
- Battle Cat Short Stick BC 18-19
- Battle Cat Inline BC 20-21
- Battle Cat Buster BC 20-21
- Battle Cat Godzilla BC 20-21
- Silu Spin BC 22-23
- Silu Cast BC 22-23
- Cat Light Spin BC 22-23
- Silu Vertical BC 22-23
- Bait Maker Feeder BC 24-25
- Passion Pro DX BC 24-25
- Passion Pro DX Long Range BC 24-25
- Passion Pro DX Boat BC 24-25
- Passion Pro DX Boat Spin BC 26-27
- Passion Pro DX Spin BC 26-27
- Passion Pro DX Vertical BC 28-29
- Passion Pro DX Mix BC 28-29

**ACCESSORIES**

- Line BC 30-31
- Hooks BC 32-34
- Swivel BC 35-36
- Pliers, Rod Pod BC 37-39
- Bite indicator BC 40
- Floats & Accessories BC 41-44
- Accessories, Leads BC 45-47
- Rigs BC 48-51
- Rigs & Jigheads BC 52-53
- Spinner & Lures BC 53-55
- Shads & Teaser BC 56-57
- Clonks BC 58
- Bags, Luggage & Accessories BC 59-64
- Sun glasses BC 65
- Mats & Tents BC 66-67
- Clothing & Accessories BC 68-73
- Promotional items BC 74



## BLACK CAT – THE BEST WAY TO CATCH

Modern cat fishing is booming and is currently more popular than ever. For years, Zebco Europe has offered the catfish angler innovative new products, practical small accessories and ultra-strong, high-quality rods and reels.

Stefan Seuß, one of the world's most successful and renowned catfish experts, invests all of his know-how and experience in the product range, delivering new products and methods every year to guarantee targeted catches of large catfish. Following the principle that 'to stand still is to move backwards', Black Cat strives to improve every year, to move with current trends and to meet the demanding requirements of the European catfish scene.

To do so, Stefan Seuß is supported by a staff of the most successful and innovative catfish anglers from all over Europe. The Black Cat team sets standards at the water every day, whether in Germany, France, Spain or Italy. Black Cat equipment has accounted for more than 25 catfish over the 100-kilo mark in recent years; a benchmark unrivalled by any other tackle manufacturer.

Black Cat - What Else ;-)



New: mega size #105. Schnurfassung 700m/0,45mm

### BLACK CAT EXTREME FD

The workhorse for catfish anglers. If you want to mix it with giant fish, you are going to need extreme equipment. The Black Cat Extreme offers a huge line capacity, an indestructible stainless steel axle and a power handle for optimal power transfer combined with an ultra-strong drag. As a catfish angler, this reel will equip you for every situation, whether you want to present your bait over 300 metres away when fishing long-range or even directly among obstacles for "no holds barred" angling. A fighting machine for every application. In contrast with the size #95 version, the new model (size #105) with its simply incredible line capacity has a manual bail arm.

#### STANDARD TECHNICAL EQUIPMENT:

- Rotor produced in aluminium to be completely distortion-free
- Aluminium body and sidecovers
- Oversized multi-stack drag system
- Aluminium spool
- Oversized handle knob for optimal power
- Titanium-nitride-coated line roller with anti-twist system
- Aluminium spool
- S-curve line distribution
- Multistop anti-reverse clutch



Code	Model	m / mm	Gear Ratio	Retrieve	BB	Drag F.	Weight
0273 095	495	540 / 0,45	4,4:1	108 cm	4	27,2 kg / 60 lbs	1084 g
0273 105	4105	700 / 0,45	4,4:1	110 cm	4	27,2 kg / 60 lbs	1084 g

Spare Spool	Model	Material
0986 031	Sp.Spool BC Extreme FD495	Alu
0986 032	Sp.Spool BC Extreme FD4105	Alu





**BATTLE CAT SPIN FD**

Specialist angling with artificial lures for catfish is now highly popular. For the active angler, Black Cat has introduced a spinning reel that leaves nothing to be desired. Four sizes cover a range of applications, such as long-cast angling with heavy lures over long distances, fishing at mid-range for bank wanderers, short-range fishing for boat anglers who want to present their bait close to hot spots from a moving boat or jigging close to the bottom with heavy weights for vertical angling fans. The reel is built to last forever and is specially equipped for use with braided lines. The axle, gears and bail are as good as indestructible. The heat-dissipating drag system will give even the biggest catfish a good fight.

**STANDARD TECHNICAL EQUIPMENT:**

- Rotor produced in aluminium to be completely distortion-free
- Housing produced in aluminium to be completely distortion-free
- Oversized multi-stack Offshore drag system
- CNC stainless steel handle
- Titanium-nitride-coated line roller
- Exclusive TiMag™ system: Maintenance-free magnetic bail arm folding system
- Gears made from a super-hard stainless steel alloy
- Aluminium Long Stroke™ spool
- S-curve line distribution
- Foot Forward™ reel foot for better rod balance

**BLACK CAT SHADOW SPIN FD**

Specialist angling with artificial lures for catfish is now highly popular. For the active angler, Black Cat has introduced a spinning reel that leaves nothing to be desired. Four sizes cover a range of applications, such as long-cast angling with heavy lures over long distances, fishing at mid-range for bank wanderers, short-range fishing for boat anglers who want to present their bait close to hot spots from a moving boat or jigging close to the bottom with heavy weights for vertical angling fans. The reel is built to last forever and is specially equipped for use with braided lines. The axle, gears and bail are as good as indestructible. The heat-dissipating drag system will give even the biggest catfish a good fight.

**STANDARD TECHNICAL EQUIPMENT:**

- Ultra-strong aluminium housing, sideplates and rotor
- Finely adjustable, protected Magnum CSC™ front drag system (carbon drag discs)
- Oversized handle knob for optimal power
- MegaShield™ multi-layer coating



Code	Model	m / mm	Gear Ratio	Retrieve	BB	Drag F.	Weight
0350 050	750	200 / 0,24	5,3:1	91 cm	7	12,7 kg / 28 lbs	400 g
0350 060	760	275 / 0,25	4,9:1	94 cm	7	13,6 kg / 30 lbs	680 g

Spare Spool	Model	m / mm	Material
0986 012	Sp.Spool Battle Cat Spin FD 750	200 / 0,24	Alu
0986 013	Sp.Spool Battle Cat Spin FD 760	275 / 0,25	Alu



Code	Model	m / mm	Gear Ratio	Retrieve	BB	Drag F.	Weight
0274 040	840	210 / 0,30	5,2:1	80 cm	8	10,4 kg / 23 lbs	382 g
0274 060	860	220 / 0,40	4,9:1	85 cm	8	13,6 kg / 30 lbs	617 g
0274 080	880	270 / 0,45	4,9:1	95 cm	8	18,1 kg / 40 lbs	697 g
0274 100	8100	265 / 0,50	4,9:1	105 cm	8	20,4 kg / 45 lbs	870 g

Spare Spool	Model	Material
0986 040	Sp.Spool BC Shadow Spin FD840	Alu
0986 041	Sp.Spool BC Shadow Spin FD860	Alu
0986 042	Sp.Spool BC Shadow Spin FD880	Alu
0986 043	Sp.Spool BC Shadow Spin FD8100	Alu



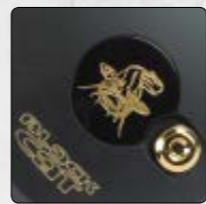
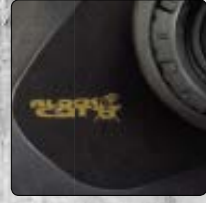

A top seller in 2017

**PASSION PRO FD**

For newcomers to catfish sport and young anglers in particular, Black Cat offers a reel that stands up to the harsh requirements of catfish angling in every department. The high line capacity combined with twist-free axle and power handle make the Black Cat Passion reel a perfect partner to the catfish rod.

**STANDARD TECHNICAL EQUIPMENT:**

- Balanced rotor, producing silky smooth action
- Robust nylon housing
- Oversized multi-stack drag system
- Die-cast aluminium handle
- Large line guide
- Thick bail arm for optimal balance
- Robust power gears
- Two-speed oscillation system
- Continuous anti-reverse



Code	Model	m / mm	Gear Ratio	Retrieve	BB	Drag F.	Weight
0345 040	640	230 / 0,22	5,2:1	76 cm	6	6,5 kg / 14 lbs	320 g
0345 060	660	300 / 0,26	4,8:1	83 cm	6	12,0 kg / 26 lbs	550 g
0345 080	680	400 / 0,30	4,8:1	94 cm	6	15,0 kg / 33 lbs	690 g
0345 100	6100	300 / 0,45	4,9:1	100 cm	6	15 kg / 33 lbs	700 g

Spare Spool	Model
0986 000	Sp.Spool Black Cat Passion 640
0986 001	Sp.Spool Black Cat Passion 660
0986 002	Sp.Spool Black Cat Passion 680
0986 007	Sp.Spool Black Cat Passion 6100

**BLACK CAT LONG RANGER**

The ultimate weapon for wels anglers. Multiplier reels play an important role in modern wels angling. Enormous line capacity, ultra-strong gears and punching out bait over very long distances are just a few factors in favour of multipliers. Other important criteria include simple feeding out of the rig through automatic braking of released line via the finely adjustable drag system. The Black Cat Long Ranger has an enormous line retrieval of 127 cm with a full spool as well as 7 ball bearings. We have deliberately omitted a line guide and T-bar to ensure perfect line outflow. Thanks to the relatively narrow yet deep spool, the line arranges perfectly when retrieved. Stefan Seuß tested the reel for a year and was hugely impressed by the reel's indestructible workmanship and the associated range of uses on the water.



Code	Model	m / mm	Gear Ratio	Retrieve	BB	Drag F.	Weight
0608 040	740	325 / 0,50	5,2:1	127 cm	7	30 kg / 66 lbs	896 g

**STANDARD TECHNICAL EQUIPMENT:**

- Fully machined one-piece aluminium housing
- MegaDrag™ stainless steel and carbon fibre drag system
- CNC stainless steel handle
- Super-hard, oversized brass gear components
- Continuous anti-reverse

Spare Spool	Model
0986 047	Sp.Spool Black Cat Long Ranger 740

kompletný cenník na [www.SPORTS.sk](http://www.SPORTS.sk), výhradný distributor pre SR: SPORTS s.r.o.





**NEW**



**BLACK CAT BUSTER**

The introduction of the Black Cat Buster offers catfish anglers a universal multiplier reel at an outstanding price-performance ratio. The housing is milled entirely from aluminium, providing a low weight of just 780 grams. The finely adjustable disc drag allows perfect drag setting during a fight as well as controlled line release when presenting your rigs. With a line capacity of 350 m/0.5 mm, the Buster perfectly covers all aspects of modern catfish angling. The high gear ratio of 6.1:1 and line retrieval of 110 cm also allow fish that bite at long distances to be steered quickly and powerfully into closer range. The Buster multiplier features a very loud clicker, which immediately alerts the angler to line removal with an unmistakable noise when a large catfish bites.

**STANDARD TECHNICAL EQUIPMENT:**

- Solid 1-piece aluminium frame
- MegaDrag™ stainless steel and carbon fibre drag system
- Extra large, secure grip handle knob
- Powerful gears
- Rapid line retrieval
- Performance Tuned Anti-Corrosion Bearings
- MegaShield™ multi-layer coating



Code	Model	m / mm	Gear Ratio	Retrieve	BB	Drag F.	Weight
0366 030	LTL 30	380 / 0,40	6,1:1	109 cm	6	8,2 kg / 18 lbs	780 g

Spare Spool	Model	Material
0982 001	Sp.Spool Black Cat Buster LTL 30	Alu



**BC<sup>2</sup>**

Baitcaster reels are the latest trend in active catfish fishing. Black Cat challenged itself to bring a robust, practically indestructible baitcaster to the market, which is up to the task of heavy bait retrieval and taming the incredible strength of a catfish. The BC Baitcaster is ideal for vertical fishing, spinning and jiggling on the bottom. The benefits of a baitcaster reel when cat fishing are obvious. At the push of a button, the angler can drop his bait to the bottom in the blink of an eye or take it to a depth where the catfish are actively hunting. With its perfect balance of a robust skeleton design combined with low weight, the reel enables hours of comfortable fishing.



Code	Model	m / mm	Gear Ratio	Retrieve	BB	Drag F.	Weight
0631 301	301 LH	210 / 0,26	5,4:1	66 cm	7	10,9 kg / 24 lbs	273 g

Spare Spool	Model	Material
0984 090	Sp.Spool BC BC <sup>2</sup> LH	Alu

kompletný cenník na [www.SPORTS.sk](http://www.SPORTS.sk), výhradný distribútor pre SR: SPORTS s.r.o.





Code	Model	Length	Sections	C.W.	Tr-Length	Weight
16451 285	The Pellet	2,85 m	2	500 g	1,45 m	540 g

### THE PELLETT

Fishing with pellets and boilies for catfish is highly popular and very successful on many waters in Europe. In collaboration with the most successful pellet angler in Europe, Lee Franchetti, we have developed the perfect rod for use with pellets or boilies on leger rigs. The rod blank enables sensitive bite detection when the catfish takes up the bait, but it is during the fight that the 285 cm rod shows its true colours via an ultra-strong parabolic action. In testing, the rod accounted for monsters over 90 kg, which were tempted by pellets and landed after some die-hard fighting from the bank.



Code	Model	Length	Sections	C.W.	Tr-Length	Weight
16460 180	Solid Fun	1,80 m	1	240 g	1,80 m	263 g

### SOLID FUN

The name says it all. The Solid Fun is a feather-light, one-piece full-carbon rod equipped with a 30 kg blank. The rod perfectly combines light bait retrieval and fatigue-free fishing with die-hard fighting fun. Whether vertical fishing, clonking with a catfish clonk or spinning from a boat, the Solid Fun means fun and big catfish.







Code	Model	Length	Sections	C.W.	Tr.-Length	Weight
16405 200	Fireball II	2,00 m	1	180 - 280 g	2,01 m	235 g

**FIREBALL II**

The successor to the legendary Fireball, specially designed for Fireball fishing with heavy weight heads and large baits.



Code	Model	Length	Sections	C.W.	Tr.-Length	Weight
16407 185	Vertical LS II	1,85 m	1	100 - 220 g	1,86 m	205 g

**VERTICAL LS II**

Vertical fishing in particular calls for sensitive power-blanks. For this successful angling method, the Black Cat team has developed a special one-piece Jig rod that guarantees perfect bait retrieval and high-impact fighting fun. The tip area is highly sensitive allowing the angler to detect even tentative bites.



Code	Model	Length	Sections	C.W.	Tr.-Length	Weight
16408 210	Fun Stick Collector II	2,10 m	2	120 - 300 g	1,59 m	285 g

**FUN STICK COLLECTOR II**

The Fun Stick Collector 2 has been developed in close collaboration with our French team anglers Lionel Luketa and Damien Modrak. The action of the light rod has simply incredible power reserves, making it a universal rod for spinning and active fishing with soft lures whether from the boat or the bank.



Code	Model	Length	Sections	C.W.	Tr.-Length	Weight
16409 220	Spin Mix	2,20 m	2	60 - 120 g	1,69 m	290 g

**SPIN MIX**

Special rod for light spinning with small wobblers, soft lures and spoons. The light blank allows hours of casting while the fast action and relatively stiff rod tip perfectly transmits the retrieve action of small lures via the blanks to the angler's arm. The fast action of the blank provides for powerful strikes and secure fighting properties with sufficient power reserves, even with large catfish.



Code	Model	Length	Sections	C.W.	Tr.-Length	Weight
16415 190	Verticalmania J/C	1,90 m	1	180 - 240 g	1,91 m	215 g

**VERTICALMANIA J/C**

The Verticalmania J/C is a special rod - developed by our team anglers Jérémy Dizdarevic and Cédric Rinaudo. Specially designed for modern active fishing with a deadbait rig or jigging deadbait rigs for large catfish.

kompletný cenník na [www.SPORTS.sk](http://www.SPORTS.sk), výhradný distribútor pre SR: SPORTS s.r.o.





Code	Model	Length	Sections	C.W.	Tr.-Length	Weight
16426 280	Freestyle	2,80 m	2	400 g	1,47 m	515 g
16426 300	Freestyle	3,00 m	2	400 g	1,54 m	630 g

**FREESTYLE**

Freestyle fans take note the Freestyle is available in a new design. The blank has been made even more robust with a special Duralfibre material blend, while Big Game Seaguide rings and a Fuji DPHS reel holder provide deluxe equipment. The Freestyle combines all of the requirements of a perfect wels rod and is a true all-round talent on the European scene.



Code	Model	Length	Sections	C.W.	Tr.-Length	Weight
16425 240	Freestyle Boat	2,40 m	1+1	400 g	1,46 m	450 g

**FREESTYLE BOAT**

Boat fishing for wels is becoming increasingly popular and many wels anglers often stay on their floating homes for several days to fish inaccessible swims. The Freestyle Boat has been developed precisely for this purpose since deadbaiting from the boat does not require a long rod and the angler is actually better equipped with a short rod. The Freestyle Boat can be fished with a multiplier or fixed-spool reel while the Uptime rod joint provides bear-like strength in a fight and saves space during transport. The Freestyle Boat is fitted with eight indestructible Seaguide rings and a Fuji DPHS reel holder that holds all standard reel models securely. Finally, Freestyle fans have the perfect rod for active and passive fishing from a boat.



Code	Model	Length	Sections	C.W.	Tr.-Length	Weight
16424 285	Wild Cat'z	2,85 m	1+1	300 g	1,91 m	510 g



**WILD CAT'Z**

Those who like to fish for wels off the beaten track cannot look past the WILD CAT'z! The rod has been developed by Peter Merkel. The result is an all-round partner in a unique, inconspicuous design. The Uptime joint provides a fully parabolic action almost equivalent to that of a one-piece rod for fatigue-free fighting from the boat yet sufficient power for long-distance buoy fishing from the bank. Equipped with an indestructible DF blank, Fuji reel holder and Seaguide rings, this rod is a match for any adventure.



kompletný cenník na [www.SPORTS.sk](http://www.SPORTS.sk), výhradný distribútor pre SR: SPORTS s.r.o.





Code	Model	Length	Sections	C.W.	Tr.-Length	Weight
16400 220	Battle Cat Fun	2,20 m	1+1	200 g	1,64 m	309 g

**BATTLE CAT FUN**

The magic wand in the Battle Cat Range. The Fun is a universal talent suited to light and medium spinning and clonking and jigging with small to medium-sized soft lures on the bottom. Thanks to the Uptime handle design, the blank can withstand the highest stresses, yet remains light and sensitive. Fighting fun is guaranteed.



Code	Model	Length	Sections	C.W.	Tr.-Length	Weight
16401 270	Battle Cat Spin	2,70 m	2	80 - 180 g	1,39 m	348 g

**BATTLE CAT SPIN**

The all-rounder when it comes to modern spinning for monster specimens. With a length of 270 cm and a casting weight of 80-180 g, the Battle Cat Spin covers all bases in modern spinning. The rod is equally suited to sensitively retrieving small wobblers as it is to punching out large and heavy spoons. The components used for this high-end spinning rod leave nothing to be desired and guarantee the catfish angler high standards in quality and strength.

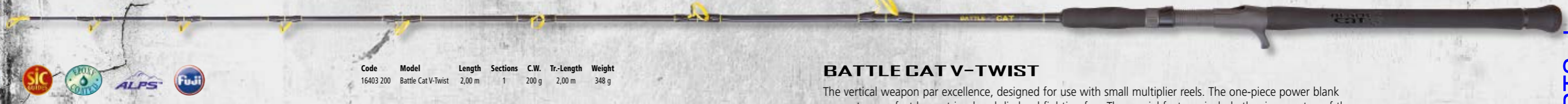

Code	Model	Length	Sections	C.W.	Tr.-Length	Weight
16403 200	Battle Cat V-Twist	2,00 m	1	200 g	2,00 m	348 g

**BATTLE CAT V-TWIST**

The vertical weapon par excellence, designed for use with small multiplier reels. The one-piece power blank guarantees perfect lure retrieval and die-hard fighting fun. The special features include the rings on top of the blank, which guarantee optimal line guidance and loading on the blank.



Code	Model	Length	Sections	C.W.	Tr.-Length	Weight
16403 290	Battle Cat Multi Style	2,00 m	1	500 g	2,00 m	473 g

**BATTLE CAT MULTI STYLE**

Special rod for use with multiplier reels whether from the bank or the boat. This rod is designed for die-hard angling in conjunction with a multiplier reel and has an optimal test curve during a fight thanks to the high number of rings. Even long-range fishing is easily mastered with the Multi Style.







Code	Model	Length	Sections	C.W.	Tr.-Length	Weight
16404 200	Battle Cat Vertical	2,00 m	1	200 g	2,00 m	312 g

**BATTLE CAT VERTICAL**

The workhorse for active fishing. The Battle Cat Vertical combines a light yet indestructible blank with immense power. The speed and sensitivity of this rod are incredible. Every knock on the vertical bait is felt right down the rod blank. Continuous raising of even heavy lures is effortless thanks to the sophisticated arrangement of the handle, reel holder and rings. The rod reacts instantly to a bite, transmitting the angler's strike brutally and directly to the fish with no cushioning. The Battle Cat Vertical can be fished with a fixed-spool or multiplier reel.



Code	Model	Length	Sections	C.W.	Tr.-Length	Weight
16406 270	Battle Cat Boat	2,70 m	2	400 g	2,03 m	508 g

**BATTLE CAT BOAT**

The Battle Cat Boat has been specially designed for modern boat fishing. The rod is equally suited to drifting or fishing taut rigs from an anchored boat. The balanced blank parabolics allow the angler to reliably fight large catfish and has extreme power in reserve without troubling the angler when fighting from a boat. The Battle Cat Boat can be used with either a multiplier or fixed-spool reel.



Code	Model	Length	Sections	C.W.	Tr.-Length	Weight
16424 200	Battle Cat Short Stick	2,20 m	1+1	60 - 100 g	2,20 m	289 g

**BATTLE CAT SHORT STICK**

Catfish are spreading rapidly over Europe. However, in several regions, the average size of the fish is not yet very high. Especially for those rivers and lakes, we developed the Short Stick in cooperation with our Belgian team member Thomas Sintobin. The Short Stick is a light catfish rod that bends fantastically and will give you lots of pleasure, even when playing smaller cats. Nevertheless, this one-section rod has plenty of backbone and is unbreakable, so that it is perfectly capable to tame very large catfish too, should you hook one. The Short Stick has been specially designed for fishing from kayaks and bellyboats, with a shorter handle than usual and a safety ring underneath, so that you can secure the rod to your boat when things get rough.







Code	Model	Length	Sections	C.W.	Tr.-Length	Weight
16414 220	Battle Cat Inline	2,20 m	1+1	150 - 250 g	1,59 m	354 g

**BATTLE CAT INLINE**

Inline rods have been the preferred choice of many French and Italian catfish anglers for many years. This rod type is ideally suited to active vertical angling, clonking and jigging. The carbon inline blank offers a fantastic and almost indestructible action. Line tangling in the rings is a thing of the past thanks to line guide. Excellent for freestyle catfish fishing where the angler holds the line in his hand and strikes by hand. The true strength in this rod is particularly evident during the fight, but for the catfish their efforts are in vain. Threader included.



Code	Model	Length	Sections	C.W.	Tr.-Length	Weight
16402 285	Battle Cat Buster	2,85 m	2	500 g	1,47 m	493 g
16402 300	Battle Cat Buster	3,00 m	2	500 g	1,55 m	523 g

**BATTLE CAT BUSTER**

The cult rod. No other rod has landed more 100-kilo catfish than the Buster. However, the Battle Cat Buster has been yet further upgraded compared with its predecessors to achieve incredible balance in terms of power and parabolics. Big Game rings and a Fuji reel holder make the Battle Cat Buster a universal rod for the catfish angler. Wherever you are in the world, with a Battle Cat Buster, you are ideally equipped to take on a monster catfish.



Code	Model	Length	Sections	C.W.	Tr.-Length	Weight
16416 320	Battle Cat Godzilla	3,20 m	2	800 - 1000 g	1,66 m	684 g
16416 280	Battle Cat Godzilla	2,80 m	2	800 - 1000 g	1,55 m	684 g

**BATTLE CAT GODZILLA**

The name says it all. With a length of 320cm and casting weight of 1,000 g, the Battle Cat Godzilla is the ultimate weapon for defeating boss monsters. When a swim is lined with the kind of obstacles that form the habitat of Europe's largest catfish, when there are brutal fights to be won without compromise and when the conditions require you to fish at distances of more than 300 metres... - the Battle Cat Godzilla comes into its own.







Code	Model	Length	Sections	C.W.	Tr.-Length	Weight
16472 200	Silu Spin	2,00 m	1	180 g	2,00 m	220 g

**SILU SPIN**

The Silu Spin was developed in cooperation with Thomas Bula. Not only a feast for the eyes but also the ideal rod for modern short spinning. This involves fishing at short distances from the boat or overgrown banks and flicking your lure straight in front of the catfish mouth. The one-piece blank guarantees perfect lure control and an abundance of power in close-range fights. This light yet fast rod produced with only the best materials takes all of the effort out of active sessions from a canoe or belly boat over several hours. The ultimate fun factor is guaranteed.



Code	Model	Length	Sections	C.W.	Tr.-Length	Weight
16473 200	Silu Cast	2,00 m	1	180 g	2,00 m	210 g

**SILU CAST**

The Silu Cast is a special rod fitted with a trigger handle for light and intermediate catfish angling. With its stylish BC design and indestructible blank, the well-balanced rod provides for sensitive bait retrieval during active fishing for catfish. The parabolic action with soft-touch tip enables the smallest lures to be cast out with control and jigged on the bottom yet has sufficient power to attractively present vertical rigs of over 120 grams in a strong current.



Code	Model	Length	Sections	C.W.	Tr.-Length	Weight
16470 240	Cat Light Spin	2,40 m	2	10 - 150 g	1,20 m	255 g
16470 260	Cat Light Spin	2,60 m	2	10 - 150 g	1,30 m	270 g
16470 280	Cat Light Spin	2,80 m	2	10 - 150 g	1,40 m	285 g

**CAT LIGHT SPIN**

Targeted spinning for catfish is highly successful and increasingly popular. Our latest findings and our experiences on the water show that the smaller lures in particular can often yield better results than XXL spoons. The new Cat Light Spin is specially designed for use with small plugs, light soft lures and spinnerbaits. The slender DF blank guarantees excellent casting and fighting properties. The Light Spin is available in three lengths. The 2.6 m version is particularly suited to boat anglers and short-range fishing from the bank while the 2.8 m version is designed for long-range casting from the bank.



Code	Model	Length	Sections	C.W.	Tr.-Length	Weight
16471 160	Silu Vertical	1,60 m	1	100 - 250 g	1,60 m	185 g

**SILU VERTICAL**

The successful "Silu" rod range has been extended with the Silu Vertical, a special rod for fans of very short and rapid rod blanks for active fishing with vertical rigs in a stylish Black Cat Design. The slender one-piece DF blank with a length of 160 cm is perfectly suited to presenting baits sensitively beneath the boat, allowing the angler to react to even the most cautious bites with a firm strike. The one-piece power blank delivers fantastic fighting properties when taking on giants directly beneath the boat.







Code	Model	Length	Sections	C.W.	Tr.-Length	F. Tips	Weight
16480 280	Bait Maker Feeder	2,80 m	2	120 g	1,40 m	4	200 g
16480 360	Bait Maker Feeder	3,60 m	3	120 g	1,25 m	4	230 g

Code	Model	provided Feeder Tips
16480 280	Bait Maker Feeder	1,5oz, 3oz, 4oz
16480 360	Bait Maker Feeder	1,5oz, 3oz, 4oz

**BAIT MAKER FEEDER**

Successful catfish fishing requires a wide selection of lures. On the Po, the catfish like mullet while on the Rhone they prefer XXL bream and on the Ebro, carp are on the menu. A good catfish angler needs the perfect equipment for catching baitfish on every tour. It is precisely for this reason that we have developed a universal rod equipped for all situations from hard-core river fishing to light stillwater sport. With the BC Bait Maker, you are always on safe ground, with the opportunity to use three interchangeable tips, each with different casting weights. The BC-Bait Maker is produced in the proven and robust Black Cat quality, impressing with two-legged rings and a design to satisfy the toughest demands of a catfish angler.



Code	Model	Length	Sections	C.W.	Tr.-Length	Weight
16417 240	Passion Pro DX	2,40 m	2	600 g	1,25 m	320 g
16417 270	Passion Pro DX	2,70 m	2	600 g	1,42 m	394 g
16417 300	Passion Pro DX	3,00 m	2	600 g	1,57 m	483 g
16417 320	Passion Pro DX	3,20 m	2	600 g	1,67 m	544 g

**PASSION PRO DX**

Value-for-money all-round rod for buoy fishing and legering for wels. The Passion Pro series combines high-quality equipment with a highly robust blank.



Code	Model	Length	Sections	C.W.	Tr.-Length	Weight
16418 330	Passion Pro DX Long Range	3,30 m	2	600 g	1,73 m	611 g

**PASSION PRO DX LONG RANGE**

Value-for-money all-round rod for fishing at long range with a buoy or leger rig. Bank anglers are also impressed by the Passion Pro since the blank length of 330 cm enables enormous casting distances.



Code	Model	Length	Sections	C.W.	Tr.-Length	Weight
16419 250	Passion Pro DX Boat	2,50 m	2	400 g	1,25 m	347 g

**PASSION PRO DX BOAT**

The Passion Pro Boat covers all angling methods used in boat fishing. Thanks to the Power blank, the rod can be used for drift fishing, vertical fishing with heavy weights, clonking and tightening natural bait rigs from a boat. The perfect rod for newcomers to modern boat fishing.



kompletný cenník na [www.SPORTS.sk](http://www.SPORTS.sk), výhradný distribútor pre SR: SPORTS s.r.o.





Code	Model	Length	Sections	C.W.	Tr.-Length	Weight
16420 240	Passion Pro DX Boat Spin	2,40 m	2	50 - 190 g	1,26 m	256 g

**PASSION PRO DX BOAT SPIN**

The Passion Pro Boat Spin is the perfect rod for active fishing from the boat. With a length of 240 cm and a casting weight of 50 to 190 g, the rod can cast and retrieve a wide range of different artificial lures perfectly. Whether jigging with soft lures, casting spoons or trolling with wobblers, the Passion Pro Boat Spin always gives an excellent account of itself.



Code	Model	Length	Sections	C.W.	Tr.-Length	Weight
16420 270	Passion Pro DX Spin	2,70 m	2	60 - 200 g	1,40 m	317 g

**PASSION PRO DX SPIN**

The Passion Pro DX Spin is the perfect rod for active fishing. With a length of 270 cm and a casting weight of 60 to 200 g, the rod can cast and retrieve a wide range of different artificial lures perfectly. Whether jigging with soft lures, casting spoons or wobblers, the Passion Pro DX Spin always gives an excellent account of itself.







Code	Model	Length	Sections	C.W.	Tr.-Length	Weight
16421 180	Passion Pro DX Vertical	1,80 m	1	230 g	1,80 m	190 g

**PASSION PRO DX VERTICAL**

Vertical fishing rocks and can be applied anywhere. In the Passion Pro Vertical, wels anglers can get their hands on a real gem at an affordable price. The rod's blank has a through action and a casting weight of 230 g, while the length of 180 cm means the model is still convenient to transport. The Passion Pro Vertical can be fished with a multiplier or fixed-spool reel.



Code	Model	Length	Sections	C.W.	Tr.-Length	Weight
16422 210	Passion Pro DX Mix	2,10 m	1+1	200 g	1,60 m	262 g

**PASSION PRO DX MIX**

The all-round rod for the active angler. The Passion Pro Mix covers everything that makes wels fishing fun. The blank's Uptide joint ensures huge power reserves during the fight while still allowing for sensitive lure movement. Whether clonking, vertical fishing, spinning or drift fishing, the Passion Pro Mix covers all bases.





spliceable

spliceable



**BATTLE CAT LINE SPINNING**

Special braided line for spinning. The special braiding process creates a smooth and round line profile, ensuring long casting distances, smoother line retrieval onto the reel and practically zero water absorption.

Code	Ø	Length	BS	Content	Colour
2350 035	0,35 mm	300 m	35 kg / 77 lbs	1 pcs	yellow
2350 045	0,45 mm	300 m	45 kg / 99 lbs	1 pcs	yellow

**BATTLE CAT LINE VERTICAL**

Specially developed high-performance line for vertical fishing. The tight braid and low water absorption of almost 0% enable perfect lure retrieval with incredible strength and durability.

Code	Ø	Length	BS	Content	Colour
2350 050	0,50 mm	300 m	60 kg / 132 lbs	1 pcs	yellow

spliceable



**BATTLE CAT LINE BAITFISH**

High-performance catfish line for all methods of uncompromising catfish sport. The yellow colour provides extremely good visibility in all weather conditions and in the beam of a head-torch at night. Particularly tight, round braid with no water absorption and extreme resistance to repeated contact with the bottom are the hallmarks of this line endorsed by Stefan Seuß.

Code	Ø	Length	BS	Content	Colour
2350 155	0,55 mm	1000 m	80 kg / 176 lbs	1 pcs	yellow

**CATLINE SPIN/CLONK**

A line specially designed for spinning and clonking for big Catfish. The tight braid combined with high durability and a minimal water intake of almost 0% enables longer casts and results in fewer tangles on the cast. The orange colour makes the line highly visible to the angler even in poor weather and enables bait movements to be perfectly controlled. The low water resistance pays off when clonking and means even tentative bites are immediately transmitted to the rod.

Code	Ø	Length	BS
2348 038	0,38 mm	200 m	27,5 kg / 61 lbs
2349 045	0,55 mm	200 m	45 kg / 90 lbs
2349 070	0,70 mm	250 m	70,0 kg / 155 lbs

NEW



**FRONT ZONE LEADER**

The leader is a crucial element of your rig in catfish angling. Whether there are stones, mussels or sharp obstacles in the water, the BC Frontzone Leader will protect your terminal tackle thanks to its incredible durability. The black super braid sets itself apart with its 1 mm diameter and 100 kg breaking strain. A major advantage is that the BC Frontzone Leader can be spliced to create a perfect connection with any main line.

Code	Ø	Length	BS	Colour
2365 100	1,00 mm	50 m	100 kg / 220 lbs	black

Trade Pack 5 Pieces



**BLACK CAT MONO LEADER**

Monofilament leaders are one of the secrets of the success of Catfish specialists. Incredibly friction resistant, invisible, self-hooking due to the stiff rig characteristics and anti-twist, to mention only a few selling points. Mono Leader is suitable for clonk angling, legering and buoy fishing. This leader material is indestructible and Stefan's first choice for large Catfish sport.

Code	Ø	Length	BS
2345 120	1,00 mm	50 m	54 kg / 120 lbs
2345 150	1,20 mm	50 m	68 kg / 150 lbs
2345 170	1,30 mm	50 m	77 kg / 170 lbs

Trade Pack 10 Pieces

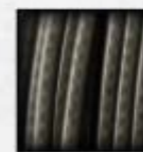

**RUBBER COATED LEADER**

The Black Cat Rubber Coated Leader provides catfish anglers with numerous sophisticated rig options. The core of the leader is a soft yet highly durable braid while the outer layer is rigid and very smooth. Parts of the outer layer can be removed to make the leader rigid and tangle-free towards the top of the rig and soft and flexible towards the bait to retain optimal bait movement. It is also possible to use the Rubber Coated Leader as a stiff rig, which is advantageous in a strong current and reduces twisting of the leader through heavy bait movement.

Code	Length	BS	Colour
2399 070	20 m	70 kg / 154 lbs	grey
2399 100	20 m	100 kg / 220 lbs	grey

Trade Pack 5 Pieces

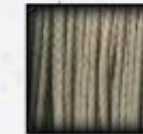

**BLACK CAT POWER LEADER**

The leader is the link between catfish and angler and makes the difference between success or defeat. That is why Black Cat uses only the best materials and a tight interlacing of countless individual strands. The Power Leader is incredibly durable yet soft and supple so that the catfish does not suspect a thing when taking the bait. The leader is suitable for all conceivable types of bait presentation and is Stefan's first choice when it comes to using braided leaders. In 2012 and 2013, the leader accounted for several 100-kilo catfish including two record fish on the Po of 122.5 and 127 kg.

Code	Ø	Length	BS
2342 050	0,70 mm	20 m	50 kg / 110 lbs
2342 080	1,00 mm	20 m	80 kg / 176 lbs
2342 100	1,20 mm	20 m	100 kg / 220 lbs
2342 150	1,40 mm	20 m	150 kg / 330 lbs

Trade Pack 5 Pieces





**CURVED POINT TREBLE HOOK**

Code	Hook Size	Content	Colour
4349 001	1	5 pcs	tin
4349 100	1/0	5 pcs	tin
4349 200	2/0	5 pcs	tin
4349 300	3/0	5 pcs	tin
4349 400	4/0	5 pcs	tin

Trade Pack 5 Pieces



**TREBLE HOOK**

Code	Hook Size	Content	Colour
4397 001	1	5 pcs	tin
4397 100	1/0	5 pcs	tin
4397 200	2/0	5 pcs	tin
4397 300	3/0	5 pcs	tin
4397 400	4/0	5 pcs	tin

Trade Pack 5 Pieces



**POWER RIG HOOK**

Code	Hook Size	Content	Colour
4394 500	5/0	6 pcs	black nickel
4394 600	6/0	6 pcs	black nickel
4394 700	7/0	6 pcs	black nickel

Trade Pack 10 Pieces



**MEGA HOOK**

Code	Hook Size	Content	Colour
4348 600	6/0	6 pcs	black nickel
4348 800	8/0	6 pcs	black nickel
4348 110	10/0	6 pcs	black nickel
4348 112	12/0	6 pcs	black nickel

Trade Pack 5 Pieces



**RIGGING HOOK**

Code	Hook Size	Content	Colour
4392 400	4/0	6 pcs	tin
4392 600	6/0	6 pcs	tin
4392 800	8/0	6 pcs	tin

Trade Pack 10 Pieces



**POWER HOOK**

Code	Hook Size	Content	Colour
4395 500	5/0	6 pcs	black nickel
4395 600	6/0	6 pcs	black nickel
4395 700	7/0	6 pcs	black nickel

Trade Pack 10 Pieces

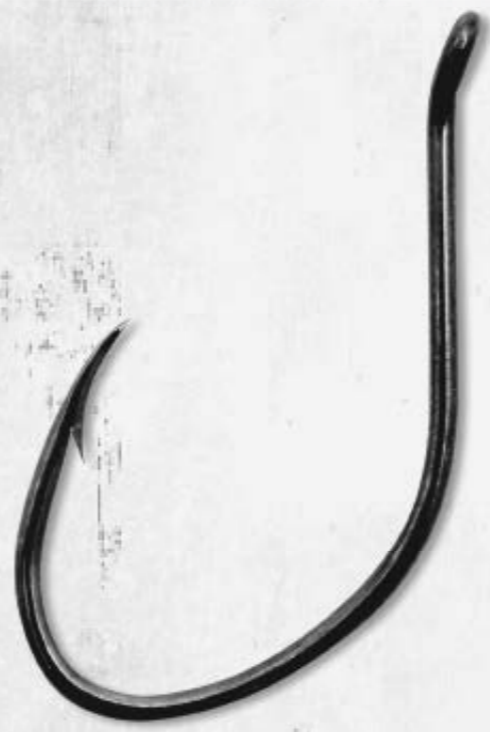

**BLACK CAT SINGLE HOOK MEGA**

Code	Hook Size	Content	Colour
4375 400	4/0	5 pcs	black nickel
4375 600	6/0	4 pcs	black nickel
4375 800	8/0	3 pcs	black nickel
4375 110	10/0	2 pcs	black nickel

Trade Pack 10 Pieces



**GRIPPER HOOK**

Code	Hook Size	Content	Colour
4482 001	1/0	6 pcs	battlesteel
4482 002	2/0	6 pcs	battlesteel
4482 003	3/0	6 pcs	battlesteel

Trade Pack 10 Pieces

**NEW**





**GHOST RIG HOOK**

Code	Hook Size	Content	Colour
4461 500	5/0	5 pcs	black nickel
4461 600	6/0	5 pcs	black nickel
4461 700	7/0	5 pcs	black nickel

Trade Pack 5 Pieces



**GHOST DOUBLE HOOK**

Code	Hook Size	Content	Colour
4462 300	3/0	5 pcs	black nickel
4462 400	4/0	5 pcs	black nickel
4462 600	6/0	5 pcs	black nickel

Trade Pack 5 Pieces



New battlesteel coating

**GRIPPER GHOST HOOK**

Code	Hook Size	Content	Colour
4483 001	1/0	5 pcs	battlesteel
4483 002	2/0	5 pcs	battlesteel
4483 003	3/0	5 pcs	battlesteel

Trade Pack 5 Pieces

**NEW**



**BLACK CAT SOUND BALL**

Noise-making capsules containing a steel ball. Attracts the attention of predators when attached to your rig.

Code	Content
4288 002	5 pcs

Trade Pack 10 Pieces



**XTREME SPLIT RING**

Many artificial lures are fitted with simple spring rings that bend open under tensile force. Black Cat provides ultra-strong spring rings specially for large fish anglers in a range of sizes to upgrade artificial lures or even vertical lure rigs.

Code	Ø	BS	Content
6157 008	10,5 mm	50 kg	10 pcs
6157 010	12 mm	90 kg	10 pcs

Trade Pack 10 Pieces

**BLACK CAT BAITING WIRE**

Baiting wire is suited to many rigs in catfish angling. The wire is used in conjunction with the Double Hook for fixing hooks directly onto the bait or for building vertical and spinning rigs.

Code	Length	Ø	Content
6152 000	120 mm	1 mm	10 pcs

Trade Pack 10 Pieces



**X-STRONG BALL BEARING SWIVEL**

High-performance wels swivel. Silent underwater thanks to the ball bearing while also offering perfect rotation to avoid line-twist.

Code	Length	Size	BS	Content	Colour
6196 004	22 mm	4	97 kg	4 pcs	black nickel
6196 005	25 mm	5	125 kg	3 pcs	black nickel
6196 006	30 mm	6	187 kg	2 pcs	black nickel

Trade Pack 5 Pieces



**GODZILLA SWIVEL**

Extremely strong cross-lock swivel for spinning anglers in small sizes and dead-baiting anglers in the larger sizes. This swivel type is regarded as the ultimate among catfish anglers.

Code	Length	Size	BS	Content
6156 200	55 mm	2/0	50 kg	5 pcs
6156 300	62 mm	3/0	60 kg	5 pcs
6156 400	72 mm	4/0	70 kg	4 pcs

Trade Pack 10 Pieces



**HEAVY DUTY CROSS LOCK SWIVEL**

Code	Length	Size	BS	Content
6173 100	52 mm	1/0	55 kg	5 pcs
6173 300	60 mm	3/0	70 kg	5 pcs
6173 400	65 mm	4/0	100 kg	3 pcs

Trade Pack 10 Pieces



**BLACK CAT POWER SNAP**

Special snap link for quick rig changes of leaders and spinners.

Code	Length	Size	BS	Content
6155 100	22 mm	1/0	30 kg	10 pcs
6155 200	28 mm	2/0	40 kg	10 pcs
6155 300	31 mm	3/0	50 kg	10 pcs

Trade Pack 10 Pieces



**BALL BEARING SWIVEL**

Code	Length	Size	BS	Content
6175 001	40 mm	1	175 kg	2 pcs
6175 002	36 mm	2	135 kg	3 pcs
6175 004	36 mm	4	90 kg	3 pcs
6175 005	32 mm	5	65 kg	5 pcs

Trade Pack 10 Pieces





**CATFISH ROLLING SWIVEL**

Code	Length	Size	BS	Content
6174 400	33 mm	3/0	135 kg	5 pcs
6174 600	35 mm	6/0	170 kg	5 pcs

Trade Pack 10 Pieces



**HD 3 WAY SWIVLE**

Code	Length	BS	Content
6172 001	80 mm	100 kg	1 pcs

Trade Pack 10 Pieces



**BRAID SCISSOR**

Special scissors for catfish anglers that cut braided lines cleanly and sharply.

Code
6410 010

Trade Pack 5 Pieces



**BLACK CAT OUTDOOR LAMP**

Water proof and extremely energy efficient outdoor lamp, which can be used standing or hanging thanks to the clip system. At night the lamp can be used as a red marker light for bank or boat anglers. Batteries: 4xAA (not included).

Code	Ø	Height	Weight
9895 034	11 cm	17 cm	140 g



**UNI CLIP**

A universal clip swivel that enables release lines and outrigger lines to be quickly and durably attached to trees, branches and buoys.



**KNOTLESS CONNECTOR, SPIN**

Extremely durable knotless line connector. Comes in handy whenever you want to connect braided line to a swivel or other rig element without losing breaking strain. Stefan Seuß recommends the Knotless Connector unreservedly.

Code	Length	Size	Content
6116 001	25 mm	3	8 pcs
6116 002	30 mm	4	6 pcs
6116 003	34 mm	5	5 pcs

Trade Pack 10 Pieces



**CRIMP FORCEPS**

For preparing heavy duty catfish rigs when using pinch sleeves.

Code
6410 006

**HELLS BELLS**

Special catfish bell with integrated snaplight holder for reliable and loud bite indication. A special clamp fixing provides a secure hold, even with the strongest tip action.



**BLACK CAT BIG BELLS**

Special large bell that will wake you even from your deepest dreams. The small clamp if firmly attached to the rod, and the bell will not hit against the blank when a fish bites.

Code	Contents	Colour
6700 005	1 pcs	black/yellow

Trade Pack 10 Pieces



**DIAMANT HOOK SHARPENER**

The Black Cat Diamond hook sharpener is simply essential equipment for a catfish angler. With its small packing dimensions, it can fit into any tackle box and allows hook tips to be kept razor sharp at all times.

Code	Length
9701 002	16 cm

Trade Pack 10 Pieces



**BLACK CAT UNHOOKER**

Special forceps for catfish and big fish anglers for safe and fast removal of the hook from the fish's mouth. The special bend creates a powerful lever that removes even firmly-seated hooks quickly and without harming the fish.

Code	Length
6410 011	22 cm

**PINCH SLEEVES**

Aluminium, high quality design best crimped with Black Cat forceps.



Code	Ø	Content
6410 007	1,2 mm	20 pcs

Trade Pack 5 Pieces



kompletný cenník na [www.SPORTS.sk](http://www.SPORTS.sk), výhradný distribútor pre SR: SPORTS s.r.o.





**GIGA SCALE**

Monster digital scales for reliable weighing of fish up to 200 kg. Batteries: 3xAAA (not included).

Code	Weight	max. Weight	Interval	Weighing Range
9800 001	535 g	200 kg	100 g	200 kg



**NEW**

**BANKSTICK**

Extreme Long&Heavy Aluminium Bankstick for taking a single diverter or for tripod mounting with the BC Tripod Adapter to take two diverters on the BC Buzzer Bar. With an extended length of over 165 cm, the BC Bankstick is suitable for high diverter and tripod mounting.

Code	Length	Colour
1892 001	90-165 cm	black

Trade Pack 10 Pieces



**NEW**

**BUZZER BAR**

Super Heavy Aluminium Buzzer Bar for taking 2 diverters for mounting on the BC Tripod Adapter

Code	Width	Colour
8210 001	16 cm	black

Trade Pack 5 Pieces



**TRIPOD GODZILLA**

It took Stefan Seuß and his team more than twelve months to get this special pod for big-game fishing just right. The pod can be set up to hold rods securely at an enormous height (over 250cm) and allows the angler to hold lines out of the water over extreme distances, especially when river fishing, guaranteeing perfect contact with the bait. The Pod Deluxe can be fixed on muddy and sandy ground as special locking pins keep the legs from sinking or slipping. The pod can also be used on concrete surfaces, with weights attached to a hook in the middle of the tripod ensuring a firm footing. The rod butt ends are held securely in aluminum sleeves, keeping the rods in place when a catfish takes the bait violently. Special bite indicator fittings allow usage of all common models and are fixed to an especially warp resistant and extremely strong power bar. The rod fittings are adjustable in height on the slide bar to accommodate any rod length.

**Code**  
8402 040  
Trade Pack 5 Pieces



**NEW**

**TRIPOD ADAPTER**

Super Heavy Tripod Adapter for taking BC Banksticks. The screw cap on the adapter allows quick and easy assembly of the tripod and allows for compact transport dimensions. The underside of the adapter features a hook for hanging a weight to increase the stability of the tripod.

Code	Width	Colour
8250 001	5,5 cm	black

Trade Pack 5 Pieces



**NEW**

**DEFLECTOR**

Sharp stones, groynes and obstacles in the water pose a threat to our main line. The diverter ensures safe passage of the line to the bait and guides the laid out line around obstacles.

Code	Width	Colour
8251 001	5,5 cm	black

Trade Pack 5 Pieces





**BLACK CAT BITE ALARM SET 2**

Vibrating bite indicator set, consisting of two bite detectors and a radio receiver. Batteries: 1x9V (not included).

Code	Content
6802 999	2+1 pcs



**BLACK CAT RECEIVER 2**

Radio receiver for the Black Cat vibrating bite indicator. Maximum range, depending on conditions: 50 m. For up to 4 individual bite indicators. Batteries: 1x9V (not included).

Code	Content
6802 002	1 pcs



**BLACK CAT BITE ALARM 2**

Vibrating bite indicator. Attaches to the rod via a sturdy clip with ratchet fixing, can be fitted to rods with a wide range of diameters. Bite indication by alarm tone and flashing LEDs. Pitch, volume and sensitivity adjustable via three buttons on the front. Responds equally well to sudden jerks and to slow, but sustained rod bending. Batteries: 2xAAA (not included).

Code	Content
6802 001	1 pcs



**SURFACE FLOAT**

Classic outrigger float in tried and trusted design – painted all over in neon yellow.

Code	BS
5578 001	60 g
5578 002	120 g

Trade Pack 5 Pieces



**SIDE LIGHT FLOAT**

Float with hidden mounting for snaplights – inconspicuous even to the most cautious Catfish.

Code	BS
5574 001	80 g
5574 002	150 g

Trade Pack 5 Pieces



**BODY FLOAT**

Classic, indispensable buoy float. Line can be fixed in the central channel with a snaplight.

Code	BS
5571 000	50 g
5571 001	100 g
5571 002	200 g

Trade Pack 5 Pieces



**DROP FLOAT**

Classic drop shape. Line can be fixed in the central channel with a snaplight.

Code	BS
5573 001	100 g
5573 002	150 g
5573 003	200 g

Trade Pack 5 Pieces



**REFLEX FLOAT**

Special outrigger float for fishing to trees, hedges, bushes or using a stick rig. The outrigger is very light and lifts out of the water perfectly when the rig is tightened. The reflective strip allows the swim to be quickly spotted at night with the use of a headlamp.

Code	BS
5557 001	10 g
5557 002	30 g
5557 003	60 g

Trade Pack 5 Pieces



**ADJUSTABLE OUT-RIGGER**

Special outrigger system with line clip in signature yellow colour. The Adjustable Outrigger can be quickly and flexibly adapted to a variety of casting distances to an obstacle or buoy. The clip system enables fast and durable fixing of the release line.

Code	Content	Colour
5529 999	1	yellow

Trade Pack 5 Pieces



**ADJUSTABLE OUTRIGGER BLACK EDITION**

Special outrigger system with line clip in signature yellow colour. The Adjustable Outrigger can be quickly and flexibly adapted to a variety of casting distances to an obstacle or buoy. The clip system enables fast and durable fixing of the release line.

Code	Content
5529 998	1

Trade Pack 5 Pieces



**BODY FLOAT BLACK EDITION**

Classic, indispensable buoy float. Line can be fixed in the central channel with a snaplight.

Code	BS	Colour
5571 010	50 g	black
5571 011	100 g	black
5571 012	200 g	black

Trade Pack 5 Pieces







yellow



red

**LIGHTNING FLOAT**

Light and bright colours attract catfish and this new invention from Stefan Seuß combines precisely these factors in an underwater float used directly above the bait. The Lightning Float offers the catfish angler inserts on both sides for standard 4.5 mm snaplights, creating a light source directly above the bait. On clear waters in particular, the Lightning Float is an absolute catching machine.

BS	yellow	red
10 g	5591 001	5591 101
20 g	5591 002	5591 102
30 g	5591 003	5591 103
40 g	5591 004	5591 104

Trade Pack 5 Pieces

**NEW**



**SURFACE FLOAT BLACK EDITION**

Classic outrigger float in tried and trusted design – painted all over in neon yellow.

Code	BS
5578 011	60 g
5578 012	120 g

Trade Pack 5 Pieces



**NEW**



black



glow in the dark



neon red UV active

**PROPELLER U-FLOAT X-STRONG**

The godfather when it comes to presenting livebaits, deadbaits or bunches of lobworm just off the bottom. The X-Strong Propeller U-Float is machined in one piece making it indestructible. The 3 wings make the U-Float rotate on the leader even in slow-flowing water. The swirling of the water caused by the rotation of the U-Float drives catfish into an aggressive frenzy. Available in the major colours glow-in-the-dark, UV red and black.

BS	black	glow in the dark	neon red UV active
10 g	5551 010	5552 010	5553 010
20 g	5551 020	5552 020	5553 020
30 g	5551 030	5552 030	5553 030

Trade Pack 10 Pieces



**BLACK CAT FLOAT**

This float specially designed for drift fishing and shore angling can be used with the thickest lines without a hitch. The colouration ensures good visibility even in adverse weather.

Code	BS
5562 001	100 g
5562 002	150 g
5562 003	200 g
5562 004	230 g

Trade Pack 5 Pieces



**VIBRO UNDERWATER FLOAT**

With several noise-making capsules

Code	BS
5565 001	15 g
5565 002	20 g

Trade Pack 5 Pieces



**PROPELLER U-FLOAT**

The new Propeller U-Float is fitted with robust, light metal wings, which emit strong pressure waves under the water, as well as two glass rattles, which produce noise when the float rotates, attracting wels to the bait.

Code	BS
5528 010	10 g
5528 020	20 g
5528 030	30 g
5528 040	40 g

Trade Pack 5 Pieces



**U-FLOAT**

A favourite of Stefan Seuß.

Code	BS
5577 006	5 g
5577 007	7 g
5577 000	10 g
5577 001	20 g
5577 002	30 g
5577 003	40 g
5577 004	60 g
5577 005	100 g

Trade Pack 5 Pieces



**CATFISH FLOAT**

With insert tip and light stick adaptor

Code	BS
5566 001	100 g
5566 002	150 g
5566 003	250 g

Trade Pack 5 Pieces



**CATFISH FLOAT**

Round with snap light adaptor

Code	BS
5564 001	100 g
5564 002	200 g
5564 003	300 g

Trade Pack 5 Pieces



**RATTLE U-FLOAT**

Underwater lift float with embedded noise capsules to attract distant Catfish.

Code	BS
5576 001	20 g
5576 002	40 g
5576 003	60 g
5576 004	100 g

Trade Pack 5 Pieces



**AROMA UNDERWATER FLOAT**

With two microporous PSP surfaces for soaking with flavours.

Code	BS
5259 004	30 g
5259 005	40 g
5259 006	60 g

Trade Pack 5 Pieces

kompletný cenník na [www.SPORTS.sk](http://www.SPORTS.sk), výhradný distribútor pre SR: SPORTS s.r.o.





Monster Crab / brown

Bloody Worm / red

**FLAVOUR SPRAY**

Wels spray – allows the angler to spray deadbaits, worms and artificial lures as well as underwater floats and leader materials. The spray binds to the sprayed items and releases its incredible attractive effect beneath the surface.

Contents	Contents	Monster Crab brown	Bloody Worm red
100 ml	100 ml	3904 001	3904 002

Trade Pack 6 Pieces



**EVA U-FLOAT**

A new development from Stefan Seuß. The EVA U-floats behave very inconspicuously beneath the surface and can be sprayed with attractors. The U-floats have a slender, inconspicuous shape and have already delivered outstanding catches during testing.

Code	Length	BS	Content	Colour
5560 006	6 cm	10 g	2 pcs	black
5560 008	8 cm	15 g	2 pcs	black
5560 010	10 cm	20 g	1 pcs	black
5560 012	12 cm	30 g	1 pcs	black

Trade Pack 5 Pieces



**RIG TUBE**

Special rubber tube, extremely durable and elastic and ideal for a range of uses in modern catfish angling. Particularly useful for knot and hook protection, as a stopper rubber for underwater floats on monofilament leaders and for fixing the bait to the hook.

Code	Length	Ø	Content	Colour
6611 069	1,00 m	2 mm / 4 mm	1 pcs	yellow
6611 070	1,00 m	3 mm / 7 mm	1 pcs	yellow
6611 072	1,00 m	4 mm / 8 mm	1 pcs	yellow

Trade Pack 10 Pieces



**CAT PROP**

A propeller to send Catfish into a spin! The propeller simply pushes onto the leader before bait and begins to spin like wild in the current. The rotation attracts predators to the bait more quickly and incites them to bite.

Code	Length	Content
3199 001	5,5 cm	2 pcs

Trade Pack 5 Pieces

Patent 202016101519  MADE IN GERMANY

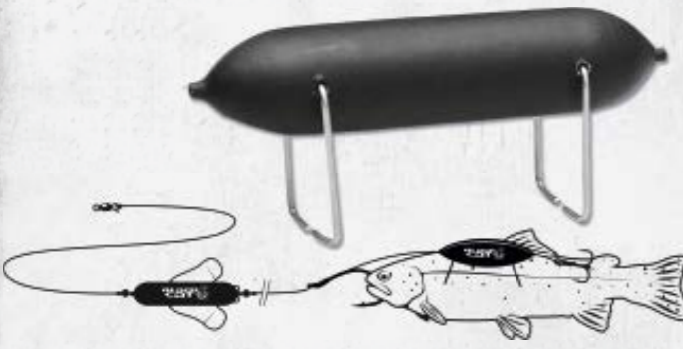

**DEAD FLOAT**

This special U-float system brings deadbaits to life and produced fantastic catches during testing and development on waters where livebaiting is banned. The floating body is positioned just behind the head on the back of the deadbait and the clips are pushed into the sides of the fish. This restores the deadbait's realistic behaviour in the water and starts to produce a tantalising swimming motion in the current without twisting. Ideal in flowing water with slender deadbaits, such as trout, chub and asp.

Code	BS	Content	Colour
5530 010	10 g	1	black
5530 020	20 g	1	black
5530 030	30 g	1	black
5530 040	40 g	1	black

Trade Pack 5 Pieces



**MARKER BUDDY**

Code	Ø	Colour
5570 002	33 cm	black

Trade Pack 5 Pieces

**BLACK CAT BAIT STOP**

Robust rubber stops for securing the hook to the bait.

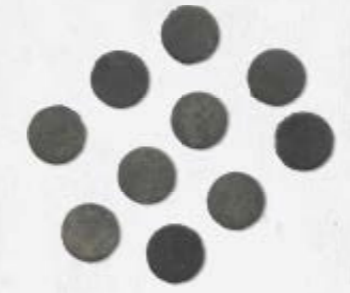

Code	Length	Ø	Content
6149 000	15 mm	15 mm	10 pcs

Trade Pack 10 Pieces

**HARD BEAD**

Hard plastic beads for attaching winged U-floats to monofilament leaders up to a diameter of 1.4 mm. Material: Plastic



Code	Ø	Content	Colour
6611 049	8 mm	50 pcs	black

Trade Pack 10 Pieces

**BLACK CAT BITE INDICATOR REST**

Screws easily onto the rod blank.



Code
6711 001

Trade Pack 5 Pieces

**BLACK CAT SILICONE SLEEVE**

Silicone tube for catfish rigs and for hook protection. Highly versatile.



Code	Length	Ø	Content
6612 005	25 mm	6 mm / 3 mm	10 pcs

Trade Pack 10 Pieces

**BLACK CAT SOFT BEAD**

Code	Length	Content
6612 006	8 mm	10 pcs

Trade Pack 10 Pieces

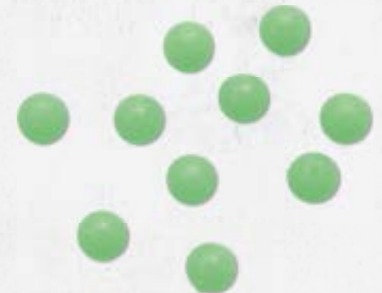

**BLACK CAT RUBBER STOP**

Code	Ø	Content
6611 051	7 mm / 3 mm	10 pcs

Trade Pack 10 Pieces



kompletný cenník na [www.SPORTS.sk](http://www.SPORTS.sk), výhradný distribútor pre SR: SPORTS s.r.o.



**BLACK CAT RUBBER SHOCK BEAD**



Code	Ø	Content
6611 050	10 mm	10 pcs

Trade Pack 10 Pieces

**RUBBER LINE STOP**



Code	Size	Content
3166 010	XXL	3 pcs

Trade Pack 10 Pieces

**NEW**



black self-luminous

**CAT BALL**

The Cat Ball is without doubt the most effective way to build effective vertical rigs. The vertical head comprises a heavy lead covered with a rubber coating in glow-in-the-dark or matt black colours and has a round design with a flattened underside. This allows the bait to be presented on the bottom without making a sound. Two stainless steel eyes protruding at 90-degree angles offer the perfect fixing points for the main line and the bait and enable rapid baiting as well as extended bait presentation without tangling.

Weight	Content	black	self-luminous
80 g	1 pcs	3145 080	3145 081
120 g	1 pcs	3145 120	3145 121
160 g	1 pcs	3145 160	3145 161
200 g	1 pcs	3145 200	3145 201

Trade Pack 10 Pieces



**BLACK CAT SILICONE TUBE**

Silicone tube for catfish rigs and for hook protection

Code	Length	Ø	Colour
6612 004	1 m	5 mm / 2 mm	black

Trade Pack 5 Pieces

**SILICON STOPPER, LONG**

Robust silicone stoppers with threading assistance for flexible and variable securing and fixing of underwater floats on the leader.

Code	Length	Content
3166 020	10 mm	10 pcs

Trade Pack 10 Pieces

**SILICON STOPPER, OVAL**

Robust silicone stoppers with threading assistance for flexible and variable securing and fixing of underwater floats on the leader.

Code	Length	Content
3166 015	7 mm	10 pcs

Trade Pack 10 Pieces



**BLACK CAT SILICONE TUBE**

Silicone tube for catfish rigs and for hook protection. Highly versatile.

Code	Length	Ø	Colour
6612 001	1 m	4 mm / 2 mm	clear
6612 002	1 m	5 mm / 2 mm	clear
6612 003	1 m	6 mm / 4 mm	clear

Trade Pack 5 Pieces



**BLACK CAT POWER BOOM**

Code	Content
6617 005	2 pcs

Trade Pack 10 Pieces



**NEW**

**FLOAT SINKER**

A catfish weight with an elongated design, which means the weight has little water resistance and is perfectly suited to all floats and drift rigs. The Float Sinker can also be rigged perfectly as a front-zone weight in strong current directly above the baitfish.

Code	Weight	Content
6649 060	60 g	4 pcs
6649 080	80 g	4 pcs
6649 100	100 g	3 pcs
6649 120	120 g	3 pcs
6649 160	160 g	2 pcs
6649 200	200 g	2 pcs

Trade Pack 5 Pieces

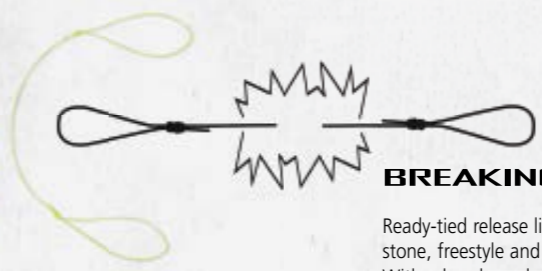

**NEW**

**BREAKING LINE**

Ready-tied release lines for stone, freestyle and buoy rigs. With a handy pack of 10 within easy reach, catfish anglers can react to any situation. Time-consuming tying of release lines is now a thing of the past.

Code	Ø	Length	BS	Content	Colour
4282 030	0,30 mm	0,15 m	6,00 kg / 13,20 lbs	10 pcs	yellow
4282 035	0,35 mm	0,15 m	7,10 kg / 15,70 lbs	10 pcs	yellow
4282 040	0,40 mm	0,15 m	9,60 kg / 21,20 lbs	10 pcs	yellow

Trade Pack 10 Pieces



**FRONT ZONE SINKER**

Code	Weight	Content
6094 020	20 g	2 pcs
6094 030	30 g	2 pcs
6094 040	40 g	2 pcs
6094 050	50 g	2 pcs

Trade Pack 5 Pieces



**INLINE OVAL LEAD**

Special catfish weight for all modern catfish rigs, including buoy fishing, drift fishing or freestyle angling.

Code	Weight	Content
6078 100	100 g	1 pcs
6078 120	120 g	1 pcs
6078 140	140 g	1 pcs
6078 180	180 g	1 pcs

Trade Pack 5 Pieces



**CLONK LEAD**

Code	Weight	Content
6040 060	60 g	1 pcs
6040 100	100 g	1 pcs
6040 160	160 g	1 pcs
6040 250	260 g	1 pcs

Trade Pack 5 Pieces



**SIDE PLANER**

Planers in two different sizes with release clip. Enables rigs to be held out in the current away from the shore. After a bite it releases and slides up underneath the leader knot so it does not interfere in the fight.

Code	Length
6329 001	15 cm
6329 002	20 cm

Trade Pack 5 Pieces

**NEW**



**BLACK CAT RUBBER BOOM**

Code	Content	Colour
6650 001	3 pcs	black

Trade Pack 10 Pieces

kompletný cenník na [www.SPORTS.sk](http://www.SPORTS.sk), výhradný distribútor pre SR: SPORTS s.r.o.





**NEW**

**SINGLE HOOK RIG WITH RATTLE**

Special ready-made leader comprising a single hook with a rattle that can be used with all bait types and angling methods.

Code	Model	Length	Hook Size	Content
4336 114	L	1,20 m	6/0	1 pcs
4336 115	XL	1,20 m	8/0	1 pcs

Trade Pack 10 Pieces



**NEW**

**U-FLOAT RIG TREBLE HOOK**

Special ready-made leader comprising a treble hook and EVA underwater float for presenting baitfish and lobworm just off the bottom.

Code	Model	Length	Hook Size	Content
4336 116	L	1,20 m	2/0	1 pcs
4336 117	XL	1,20 m	3/0	1 pcs

Trade Pack 10 Pieces

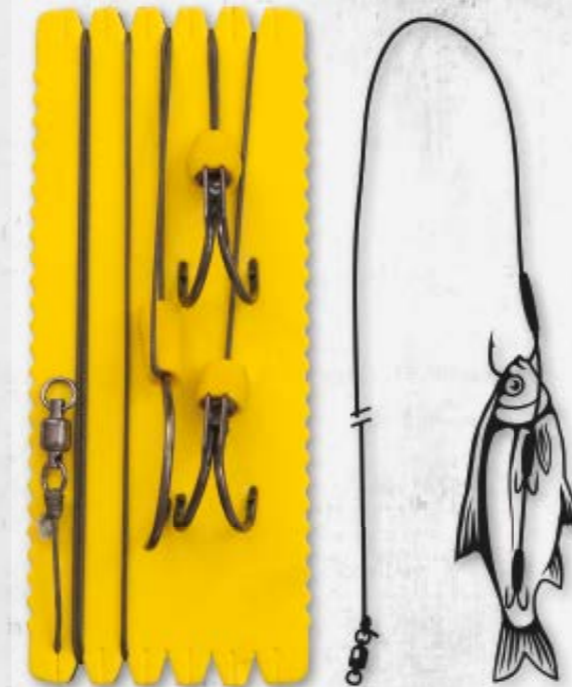

**NEW**

**BIG BAIT GHOST RIG**

Special ready-made leader with three hooks comprising one BC Mega single hook and two Ghost Hooks for presenting large baitfish when buoy fishing or legering.

Code	Model	Length	Hook Size	Content
4336 120	L	1,40 m	8/0/3/0	1 pcs
4336 121	XL	1,40 m	10/0/4/0	1 pcs

Trade Pack 10 Pieces

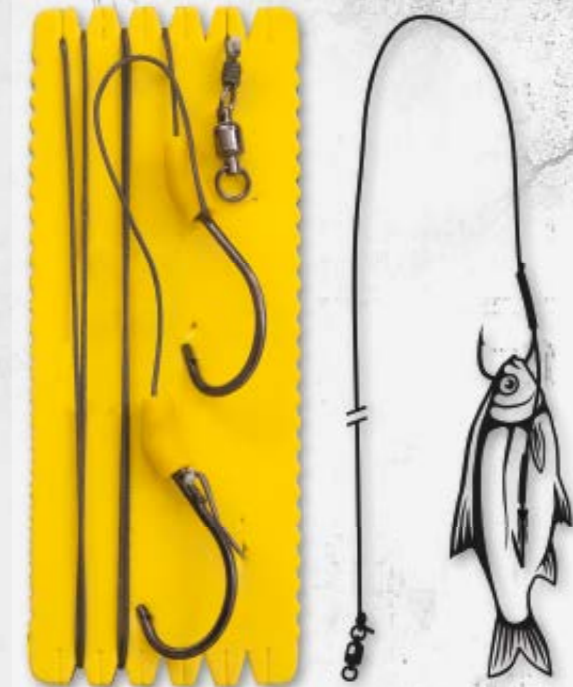

**NEW**

**BOUY AND BOAT GHOST SINGLE HOOK RIG**

Special ready-made leader with two hooks comprising one single hook and one Ghost Hook for presenting deadbaits and livebaits.

Code	Model	Length	Hook Size	Content
4336 122	L	1,40 m	6/0	1 pcs
4336 123	XL	1,40 m	7/0	1 pcs

Trade Pack 10 Pieces



**NEW**

**U-FLOAT RIG SINGLE HOOK**

Special ready-made leader comprising a single hook and EVA underwater float for presenting baitfish and lobworm just off the bottom.

Code	Model	Length	Hook Size	Content
4336 118	L	1,20 m	6/0	1 pcs
4336 119	XL	1,20 m	8/0	1 pcs

Trade Pack 10 Pieces



**NEW**

**PELLET AND CHUNK RIG**

Special ready-made leader for use with pellets and boilies for targeting catfish. The bait can simply be looped on while the hair rig ensures perfect bait presentation and reliable hooking.

Code	Model	Length	Hook Size	Content
4336 130	Short Hair	1,00 m	5/0	2 pcs
4336 131	Short Hair	1,00 m	6/0	2 pcs
4336 132	Long Hair	1,00 m	5/0	2 pcs
4336 133	Long Hair	1,00 m	6/0	2 pcs

Trade Pack 10 Pieces

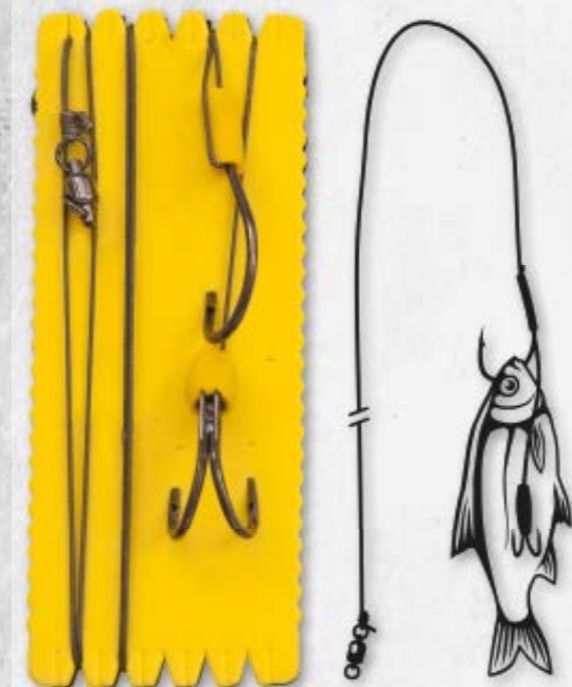

**NEW**

**BOUY AND BOAT GHOST DOUBLE HOOK RIG**

Special ready-made leader with two hooks comprising one single hook and one Ghost Hook for presenting deadbaits and livebaits.

Code	Model	Length	Hook Size	Content
4336 124	L	1,40 m	6/0/3/0	1 pcs
4336 125	XL	1,40 m	7/0/4/0	1 pcs

Trade Pack 10 Pieces



**NEW**

**U-FLOAT GHOST RIG**

Special ready-made leader with an EVA underwater float and two hooks comprising one single hook and one Ghost Hook for presenting deadbaits and livebaits in flowing water.

Code	Model	Length	Hook Size	Content
4336 126	L	1,80 m	6/0/3/0	1 pcs
4336 127	XL	1,80 m	7/0/4/0	1 pcs

Trade Pack 10 Pieces

kompletný cenník na [www.SPORTS.sk](http://www.SPORTS.sk), výhradný distribútor pre SR: SPORTS s.r.o.





**BIG BAIT RIG**

Special rig for deadbait angling with larger baits, with two trebles and one single hook.

Code	Model	Length	Hook Size
4336 101	L	140 cm	8/0/2/0
4336 102	XL	140 cm	10/0/3/0

Trade Pack 10 Pieces

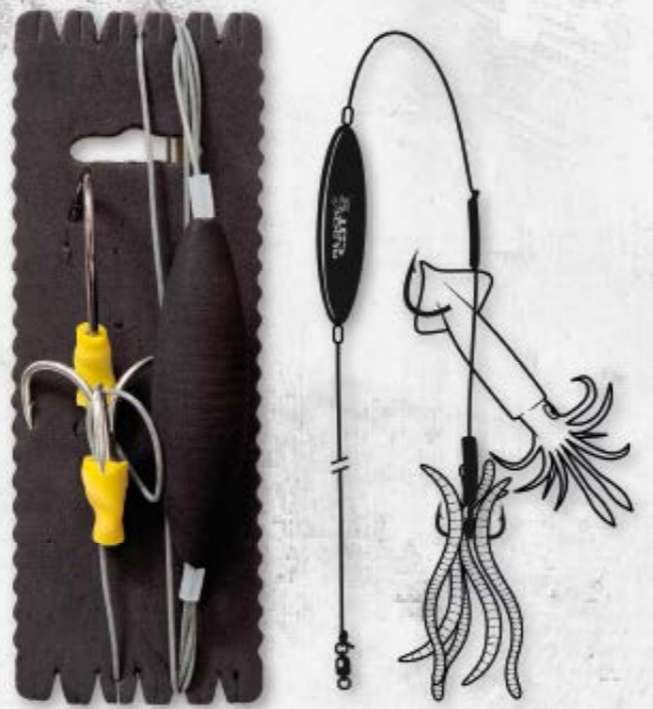

**SUBFLOAT WORM AND CALAMARI RIG**

Special leader with rattle for presenting bunches of worms and squid just off the bottom. The U-float makes the bait hang tantalisingly in open water. The leader is designed for use in flowing water while the rattle attracts the wels.

Code	Model	Length	Hook Size
4336 103	L	180 cm	2/0/6/0
4336 104	XL	180 cm	3/0/7/0

Trade Pack 10 Pieces

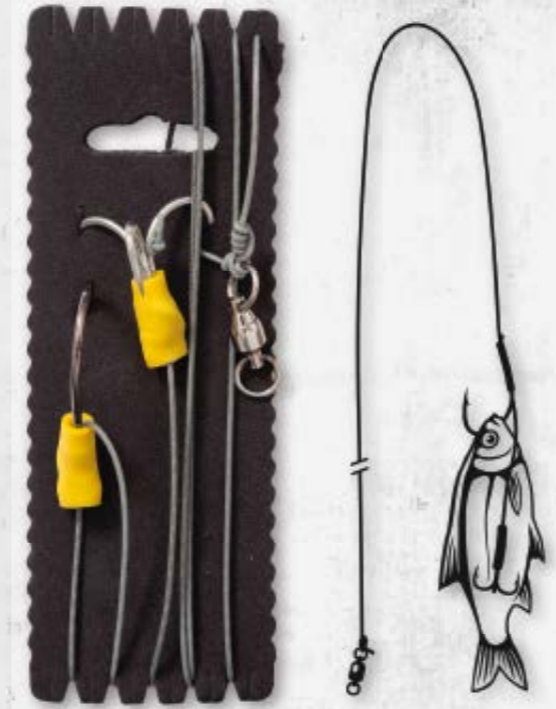

**BOUY AND BOAT RIG**

Universal leader with one treble and one single hook.

Code	Model	Length	Hook Size
4336 110	L	140 cm	2/0/6/0
4336 111	XL	140 cm	3/0/7/0

Trade Pack 10 Pieces



**GOBY RIG**

Special leader for presenting small fish or bunches of lobworm on a clip system. The leader is particularly successful on rivers and works miracles on the German Rhine when fished with gobies.

Code	Model	Length	Hook Size
4336 112	L	200 cm	2/0/8/0
4336 113	XL	200 cm	3/0/10/0

Trade Pack 10 Pieces



**HAIR RIG**

The BC Hair Rig is a special leader for use with livebaits and deadbaits as well as bunches of lobworm.

Code	Model	Length	Hook Size
4336 105	L	200 cm	4/0/8/0
4336 106	XL	200 cm	6/0/10/0

Trade Pack 10 Pieces



**UNDERWATER FLOAT RIG**

Special leader for presenting baitfish just off the bottom. The baitfish hovers above the bottom thanks to the U-float. The leader is suited to both flowing water and stillwaters.

Code	Model	Length	Hook Size
4336 107	L	180 cm	2/0/5/0
4336 108	XL	180 cm	3/0/6/0
4336 109	XXL	180 cm	4/0/7/0

Trade Pack 10 Pieces



**TACKLE KEEPER**

Robust and rain-proof plastic boxes with spacious storage compartments for all small accessories needed by the catfish angler.

Code	Width	Height	Depth	Size
8061 030	28 cm	20 cm	4,5 cm	M
8061 031	36 cm	22 cm	8 cm	XL

Trade Pack 5 Pieces



kompletný cenník na [www.SPORTS.sk](http://www.SPORTS.sk), výhradný distribútor pre SR: SPORTS s.r.o.





**HEADHUNTER JIG HEAD**

Catfish jig head for angling on still waters and in flowing water. The hooks are incredibly sharp and hard, penetrating perfectly into the hard mouth of the fish. Pull-outs are a thing of the past.

Code	Hook Size	Weight	Content
3173 009	8/0	30 g	2 pcs
3173 010	8/0	40 g	2 pcs
3173 011	8/0	60 g	2 pcs
3173 012	8/0	80 g	2 pcs
3173 100	6/0	20 g	2 pcs
3173 101	6/0	30 g	2 pcs
3173 102	6/0	40 g	2 pcs

Trade Pack 5 Pieces



**WORMBALL JIG HEAD**

Light jiggling along the bottom with lobworm is one of the most effective angling methods for catfish. In France in particular, the Black Cat catfish pros have caught countless catfish using this system. The Wormball Jig Head was used to win Europe's largest catfish competition on the Rhone. Up to 10 lobworms can be threaded onto the ring on the Jig Head, which can then be twitched along the bottom or retrieved in open water. The additional use of a catfish clonk while the Worm Jig Head is retrieved through the water is particularly effective.

Code	Weight	Content	Colour
3144 100	100 g	1 pcs	black/yellow
3144 150	150 g	1 pcs	black/yellow
3144 200	200 g	1 pcs	black/yellow

Trade Pack 5 Pieces



**DEAD BAIT RIG**

The Dead Bait Rig is a special system for use with deadbaits when active fishing from a moving boat. The deadbait is threaded onto the wire, producing a light wobbling motion. With a slow movement of the rod, the Dead Bait Rig is guided closely along the bottom, moving in slow jumps or can also be jigged with fast, jerky movements.

Code	Hook Size	Hook	Weight	BS
4211 000	2/0	2	30/50/75/100 g	100 kg

Trade Pack 5 Pieces

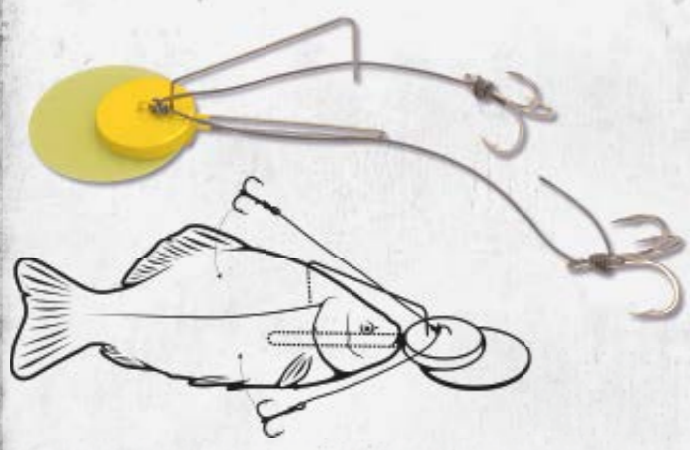

**DEAD BAIT JIG RIG**

The Dead Bait Trolling Rig enables deadbaits to stand vertically on the bottom or can also create a tantalising swimming motion when the line is retrieved. The lead plate is designed such that the bait imitates a natural swimming motion against a current or the drag of a slow-moving boat.

Code	Hook Size	Hook	Weight	BS	Colour
4212 050	2/0	2	50 g	100 kg	yellow
4212 075	2/0	2	75 g	100 kg	yellow
4212 100	2/0	2	100 g	100 kg	yellow
4212 150	2/0	2	150 g	100 kg	yellow

Trade Pack 5 Pieces



**BLACK CAT SPIN RIG**

Special rig for spinning. Prevents the lure from tangling on the cast and protects against biting.

Code	Length	BS
4336 008	50 cm	100 kg

Trade Pack 5 Pieces



**NEW**

**BATTLE SPOON**

The Battle Spoon has been specially developed by BC Team anglers for fishing with spoons for catfish. The special design creates a striking lateral motion beneath the surface and provides perfect flight properties when casting to reach even remote hotspots. The moment it hits the surface of the water, the Battle Spoon creates a thudding sound that drives catfish into a frenzy, while the strong lateral swimming motion creates swirling under the water and allows the lure to be slowly retrieved while perfectly imitating medium-sized prey.

Length	copper	gold	silver
10 cm	3095 045	3095 145	3095 245
10 cm	3095 065	3095 165	3095 265
10 cm	3095 085	3095 185	3095 285

Trade Pack 5 Pieces







**BIG SPINNER BAIT**

The BC Big Spinner Bait is best suited to shallow and weedy waters. The spinner blade creates enormous pressure while the wire frame of the spinner is designed to withstand the strongest opponents. A second rotating element on the spinner blade sends predators into a frenzy. This explains why the lure has already accounted for such good catches during the test phase as the wels do not recognise such a lure. The rubber tentacles on the high-quality single hook pulsate under water on the retrieve, stirring wels on the bottom into a frenzy.

Weight	Content	silver	grave digger	black wave
60 g	1 pcs	3001 001	3001 002	3001 003
80 g	1 pcs	3001 101	3001 102	3001 103
100 g	1 pcs	3001 201	3001 202	3001 203

Trade Pack 5 Pieces



**SPIN JIG**

The BC Spin Jig is a true revolution where modern jig hooks for catfish angling are concerned. There is a spinner blade on the hook itself, which acts as a further attraction beneath the soft lure and creates additional pressure waves. The range of applications of the Spin Jig is enormous. It can be trolled or retrieved along the bottom, in mid-water or near the surface. On the Po in Italy, the Rhine and the Rhone in France in particular, the Spin Jig was highly impressive compared with standard jig hooks. All standard soft lures can be mounted on the hook itself.

Weight	Content	silver	grave digger	black wave
20 g	1 pcs	3002 001	3002 002	3002 003
30 g	1 pcs	3002 101	3002 102	3002 103
40 g	1 pcs	3002 201	3002 202	3002 203

Trade Pack 5 Pieces



**BABY CAT**

The Baby Cat is a Black Cat invention that perfectly imitates a small catfish. The Baby Cat is fitted with a lively twister tail and has already accounted for outstanding catches during testing along with its brother, the Baby Cat Shad, both when fishing vertically and casting.

Length	Weight	Content	real cat	albino cat	purple moon	rainbow
18 cm	34 g	2 pcs	3294 001	3294 002	3294 003	3294 004
25 cm	90 g	1 pcs	3294 101	3294 102	3294 103	3294 104

Trade Pack 5 Pieces



**BABY CAT SHAD**

The Baby Cat Shad is a Black Cat invention that perfectly imitates a small catfish. Big catfish have a penchant for snacking on their lively smaller comrades and, even in testing, this rubber catfish with rear blade accounted for outstanding catches both when fishing vertically and casting. A top lure for all-year round because catfish just love snacking on their own young.

Length	Weight	Content	Hook Size	real cat	albino cat	purple moon	rainbow
18 cm	35 g	2 pcs	6/0	3295 101	3295 102	3295 103	3295 104
18 cm	50 g	2 pcs	6/0	3295 201	3295 202	3295 203	3295 204
18 cm	75 g	2 pcs	6/0	3295 301	3295 302	3295 303	3295 304

Trade Pack 5 Pieces

kompletný cenník na [www.SPORTS.sk](http://www.SPORTS.sk), výhradný distribútor pre SR: SPORTS s.r.o.





real cat

albino cat

purple moon

rainbow

**BABY SPIN CAT**

New jig in a wels design with a rotating spinner blade as a tail. Equipped with a high-quality VMC treble, a stainless steel interior and high-quality connecting materials for fixing the spinner blade for maximum flexibility of the soft plastic body.

Length	Weight	Content	Hook	Action	real cat	albino cat	purple moon	rainbow
14 cm	85 g	1 pcs	2	sinking	3268 201	3268 202	3268 203	3268 204
19 cm	150 g	1 pcs	2	sinking	3268 301	3268 302	3268 303	3268 304

Trade Pack 5 Pieces



carp



japanese koi

**BABY CARP**

Universal active lure in natural design. The Baby Carp caused a sensation during testing as its special retrieve action and natural design put any catfish into attack mode. The lure can be cast and retrieved slowly or can also be attractively presented by jiggling along the bottom.

Length	Weight	Content	Action	carp	japanese koi
12 cm	60 g	1 pcs	sinking	3265 301	3265 302
14 cm	95 g	1 pcs	sinking	3265 401	3265 402
15,5 cm	120 g	1 pcs	sinking	3265 601	3265 602

Trade Pack 5 Pieces



yellow/black

pink/white

**BATTLE TEASER**

The Battle Teaser, equipped with glass beads, is a catching machine for active anglers. The Teaser can be used as a lure when fishing with a catfish clonk or can also be jigged closely along the bottom as a vertical lure. The rubber tentacles pulsate tantalisingly in the water while the glass beads emit a loud, clanking sound in the water, which ramps up the aggression of the catfish.

Weight	Hook Size	BS	Action	yellow/black	pink/white
80 g	3/0	100 kg	sinking	6077 080	6077 081
120 g	3/0	100 kg	sinking	6077 120	6077 121
160 g	3/0	100 kg	sinking	6077 160	6077 161
200 g	3/0	100 kg	sinking	6077 200	6077 201
240 g	3/0	100 kg	sinking	6077 240	6077 241

Trade Pack 5 Pieces



black/yellow

motor oil

glow in the dark



**SMELLY TEASER**

Special teaser for active fishing with a catfish clonk or vertical fishing. The lure feature imitation leather tentacles that absorb attractors and leave behind a tantalising trail of aromas in the water. The imitation leather tentacles support a positive hooking effect since they hang in the teeth of catfish when they suck in the lure.

Weight	Hook Size	BS	black/yellow	motor oil	glow in the dark
120 g	2/0	100 kg	6260 120	6260 121	6260 122
160 g	2/0	100 kg	6260 160	6260 161	6260 162
200 g	2/0	100 kg	6260 200	6260 201	6260 202

Trade Pack 5 Pieces



kompletný cenník na [www.SPORTS.sk](http://www.SPORTS.sk), výhradný distribútor pre SR: SPORTS s.r.o.





**BLACK CAT CATFISH CLONK SHALLOW WATER**

Special Catfish clonk for use on calm waters with depths of up to 6 m.

Code	Length
6328 004	37 cm



**BLACK CAT CATFISH CLONK DEEP WATER**

Special catfish clonk for depths of 5 to 20 m. The clonk creates incredibly strong pressure waves.

Code	Length
6328 005	37 cm



**NEW**

Carbon

**BLACK CAT STEFAN SEUSS SPECIAL CLONK CARBON**

Stefan Seuß Special Catfish Clonk. The special shaft design creates strong pressure waves when clonking, making the clonk simple to use even for inexperienced catfish anglers. The entire clonk is made from carbon and is more durable than standard catfish clonks. Fatigue-free clonking is guaranteed. Material: Carbon

Code	Length	Weight	Colour
6328 011	38 cm	83 g	black/yellow



420 CARRYALL NYLON

**BLACK CAT CARRYALL**

Special bag with sufficient space for everything you need for a multi day Catfish trip and enough storage for clothes and reels. The universal carryall for any Catfish angler, highly multi-functional. Material: 100% Nylon

Code	Length	Width	Height
8515 003	68 cm	41 cm	35 cm



**BLACK CAT STEFAN SEUSS SPECIAL CLONK**

Stefan Seuß brings another absolute gem among catfish clonks to the market in this special catfish clonk design. Thanks to its special shaft design, the clonk can be quickly mastered even by beginners, to create clean pressure waves beneath the water that will attract catfish.

Code	Length
6328 008	40 cm



**BLACK CAT DZ CARBON CLONK**

A refined carbon clonk developed by French team angler Jérémy Dizdarevic. Easy to use and with a penetrating sound effect, the clonk draws catfish to the swim.

Code	Model	Length	Colour
6328 009	Standard	35 cm	carbon
6328 010	Long Shaft	49 cm	carbon



420 SPINNING NYLON



**BLACK CAT SPINNING BAG**

Bag with two plastic boxes for spinning anglers. Plenty of space for your spoons, shads, leaders and swivels. The bag is easy to carry and water and mud-resistant. Material: 100% Nylon

Code	Length	Width	Height
8515 005	38 cm	25 cm	10 cm





**BLACK CAT ACCESSORY KEEPER**

Small shoulder bag for transporting various accessories. The Velcro fasteners can be used for attachment to a belt or railing. Material: 100% Nylon

Code	Length	Width	Height
8515 001	23 cm	7 cm	7,5 cm



**BOAT ORGANIZER BAG**

Water proof and dirt-repellent small parts box with clear lid. Ideally suited as tackle organizer for use on a boat or outdoor camp. The clever arrangement of compartments allows for perfect organization of pliers, scissors, break lights, bite indicators and other tackle. The clear lid allows you to find immediately what you need.

Code	Length	Width	Height	Content
8400 044	27,5 cm	33,5 cm	8 cm	1 pcs



**BLACK CAT HOLDALL**

Special rod holdall for three made up Catfish rods with ample reel space. The side pockets are ideal for storing gloves, forceps and small tackle. Material: 100% Nylon

Code	Length	Width	Height
8515 004	1,77 m	25 cm	27 cm



**WATERPROOF BAG**

Special folding bag for boat anglers. This bag is waterproof and offers protection for camera equipment, valuables, fishfinders and clothes. Material: 100% Nylon Polychlorid coated

Code	Width	Height	Depth
8521 008	40 cm	25 cm	26 cm



**BLACK CAT BOAT BAG**

Transport bag for clothing, sleeping bag and equipment. Material: 100% Polyester

Code	Model	Length	Ø
8529 001	L	60 cm	35 cm
8529 002	XL	75 cm	40 cm



**BLACK CAT DUO ROD BAG**

Special rod bag for rapid transport and use of two rigged-up catfish rods. The rod bag can accommodate two rigged-up catfish rods fitted with big-game reels, such as the Black Cat Extreme FD. The zip fasteners are indestructible and will easily stand up to mud and sand. The seams on the carry straps are triple strength and enable safe transport and comfortable carrying during long walks to the water. Material: 100% Polyester

Code	Length	Width	Height
8515 012	1,85 m	36 cm	10 cm





**BLACK CAT SINGLE ROD BAG**

Transport bag for rigged catfish rods. Available in three lengths. Zip fastener opens along the full length. Equipped with carry handles and sufficiently large mounting to hold even large reels. Material: 100% Nylon

Code	Length	Width
8515 006	1,55 m	30 cm
8515 007	1,80 m	30 cm
8515 008	2,05 m	30 cm



**LIVE BAIT BAG**

Optimal storage for live baits, which folds comfortably for easy transport. Features a removable internal net bag which keeps the bait fresh on the boat and raised in the container during transport. On the outside is a retaining plate for the oxygen pump, while the lid enables sufficient access to remove even substantial baits. Material: 100% Nylon Polychlorid coated

Code	Ø	Height	Content
8521 009	40 cm	40 cm	50 l



**BLACK CAT COOLER BAG**

Round cooler bag for storing baits of all kinds as well as ice or cooling elements. With two carry handles and a zip-fastening cover. Material: 100% Nylon

Code	Ø	Height
8515 011	30 cm	38 cm



Supplied without line.

**LEADER DISPENSER BAG**

Special wels leader bag that allows you to neatly store three leader spools and to roll off the required leader material from the spool in the bag. Material: 100% Nylon

Code	Ø	Width	Colour	Compartments
8515 013	15 cm	11 cm	black/yellow	4



**BLACK CAT RIG WALLET**

Special protective wallet for Catfish rigs. All rigs are stored in a plastic sleeve, protected against dirt and water. Material: 100% Nylon

Code	Length	Width
8515 002	19 cm	30 cm



**ROPE KEEPER**

Special mesh bag for transport and ventilated storage of wels rope, wels sheet and wels gloves. Material: 100% Polyester

Code	Length	Width	Height
8517 053	22 cm	30 cm	22 cm

Trade Pack 5 Pieces







**BLACK CAT BAIT KEEPER**

Small, compact keepnet for keeping live bait etc. fresh and close to your boat. With buoyancy ring to keep it upright and swimming. Can be closed from the top.

Code	Ø	Width	Height	Mesh
7049 001	55 cm	39 cm	70 cm	8 x 5 mm



**BLACK CAT BAITFISH TUNNEL**

Special keepnet for boat and bank anglers. A wire spiral on the interior prevents the keepnet from collapsing and provides an optimal and protective holder for baitfish whether on stillwaters or in strong currents. The keepnet folds away economically for transport. Material: 40% Polyester, 60% Polychlorid

Code	Length	Ø	Mesh
7049 002	0,75 m	55 cm	2 x 8 mm

**NEW**



**KEEP NET**

Special keepnet for catfish anglers. The landing net mesh is rubberised to protect fish skin. The net length of 3 m allows it to be held securely whether on flowing waters or stillwaters. The landing net can be safely sealed on the top side via a pull mechanism. The robust strap also makes it ideal for boat anglers.

Code	Length	Ø	Mesh
7055 001	3,00 m	45 cm	7 x 5 mm

**NEW**



**BAIT NET**

Baitfish hand net for boat and shore anglers. The rubberised net protects fish skin. The landing net is perfectly suited to catching baitfish quickly and reliably from a keepnet or transport container.

Code	Length	Width	Height	Mesh
7040 001	0,60 m	31,50 cm	21,00 cm	15 x 10 mm



**DRIFT BAG L**

Drift Bag for all types of boat fishing on lakes and rivers. Either as an L version when using a "brake parachute" at the bow or stern of the boat or as a smaller design for using a drift bag at either side of the boat. Extremely robust yet easy to store design in nylon with 4 strong hangers. Each two sides of the opening are equipped with buoyancy aids and two with weights meaning the Drift Bag opens in seconds. The outflow funnel can be adjusted to the current conditions using the diameter. Material: 100% Nylon, Polyurethane coated

Code	Width	Height
8524 001	95 cm	95 cm
8524 002	62 cm	57 cm



**DRIFT BAG XXL**

Extremely effective driftbag working on a similar principle to a paraglider. Packs away to a very compact size and unfurls to its full size underwater to put the brakes on a boat like no other driftbag when drifting. Material: 100% Nylon, Polyurethane coated

Code	Width	Height
8524 003	140 cm	100 cm



**SUNGLASSES PASSION**

Cool sunglasses with black frames and red-gold reflective lenses. High quality with polarized lenses.

Code
8910 009

Trade Pack 3 Pieces



**SUNGLASSES BUSTER**

Cool sunglasses with yellow frames and blue reflective lenses. High quality with polarized lenses.

Code
8910 008

Trade Pack 3 Pieces

kompletný cenník na [www.SPORTS.sk](http://www.SPORTS.sk), výhradný distribútor pre SR: SPORTS s.r.o.





**HARD CORE CAT BAG**

The special weigh- and transport bag for Catfish Anglers. Eight carrying loops ensure safe and gentle transport for large catfish even in rough terrain. The Catfish rests securely in the bag and is protected from slipping out by accident, the bag can be carried by two persons. Perfectly suited for safely weighing specimens of more than 100kg. Special drainage holes made from mucous membrane friendly material are located at the underside of the bag. Especially boat anglers can take care of the catch directly on board while protecting the boat from dirt and mucus. Material: 100% Nylon

Code	Length	Width
8503 001	210 cm	156 cm



**BLACK CAT UNHOOKING MAT**

Large, robust cover in Black Cat design, protects catfish from stoney and hard surfaces. Material: 100% Polyurethane

Code	Length	Width
8517 022	300 cm	200 cm
Trade Pack 2 Pieces		



**BLACK CAT UNHOOKING AND WEIGHING MAT**

Hard-wearing unhooking mat that can also be used as a weighing mat. Can comfortably hold fish up to 100 kg. Material: 100% Nylon Polychloride coated

Code	Length	Width
8517 025	2,30 m	1,00 m



**BLACK CAT BED CHAIR COVER**

Fleece cover with water and dirt-resistant surface. The cover can be used either as a sleeping bag cover or, in the warmer months, as a blanket at the water's edge. A particular highlight is the integrated mosquito net in the upper ceiling area, which can be pulled across above the angler's head in the event of a mosquito invasion and offer protection. Material: 100% Polyurethane

Code	Length	Width	Weight
9980 034	2,10 m	148 cm	1,7 kg



**NEW**

5.000 mm water resistance

**SPECIAL BOAT CAVE II**

The new edition of the innovative boat tent from Black Cat has been upgraded with a suspended inner tent to prevent condensation. This addition makes the Boat Cave 2.0 completely unique. The robust external material with a water column of 5,000 mm provides optimal protection against adverse weather. The centrally-divided entrance door that extends down to the floor of the boat also protects the interior of the Boat Cave from windy conditions. The internal Velcro pockets allow the door to be weighed down with lead weights to prevent uncontrollable flapping in the wind. Large transparent windows allow a clear view of your rods. Alternatively, the rainproof front can be replaced with a mosquito net, offering protection from insects on mild summer evenings. The separated spreader poles ensure optimal transport dimensions and a more lightweight design; includes a tent bag for easy storage. The three proven frame supports, which stabilise the Boat Cave 2.0 in stormy weather and during transport, have been extended with two additional supports near the bow door. These increase stability significantly further again. Note: no liability is accepted for air flow damage when travelling at excessive speeds. The bow door, which has been upgraded with an all-round Velcro strip for better rainproofing, also enables entry/exit and anchoring when the Boat Cave 2.0 is erected. A further innovation on the Boat Cave 2.0 is the extension of the proven 2-arch design with a third arch at the rear of the tent. The third arch can also be braced with small telescopic poles where necessary, acting as an awning to provide further protection of approx. 30 cm in the interior of the tent. Thanks to the individual fixing points in the form of D-rings, the Boat Cave 2.0 can be securely fastened to many common boat types both in its standard length of 3.60 m and in the shortened version of 3.3 m. On the shortened version, the front telescopic arch is lowered by approx. 15 cm. The Boat Cave 2.0 can be erected on fishing / catfish boats between 1.85 m and 2.2 m wide. The optimal usable width is 2 m. Material: 100% Polyurethane

Code	Length	Width	Height	Weight	Content
9982 037	335 cm	220 cm	105 cm	7,34 kg	1 pcs







**NEW**

**HOODIE**

Material: 100% Cotton. Gram weight: 360 g/m<sup>2</sup>

Code	Size	Colour
8434 001	M	black
8434 002	L	black
8434 003	XL	black
8434 004	XXL	black
8434 005	XXXL	black



**NEW**

**LONGSLEEVE SHIRT**

Material: 100% Cotton. Gram weight: 260 g/m<sup>2</sup>

Code	Size	Colour
8430 001	M	black
8430 002	L	black
8430 003	XL	black
8430 004	XXL	black
8430 005	XXXL	black



**OVER JACKET**

The grand finale of a specimen catch is the photo shoot. It is important that you look and feel your best. The Black Cat Team have developed a quick drying Over Jacket in the Black Cat colours which protects the clothes underneath from water and catfish slime. Material: 100% Nylon. Gram weight: 70 g/m<sup>2</sup>

Code	Size	Colour
8986 001	L	black
8986 002	XL	black
8986 003	XXL	black
8986 004	XXXL	black



**OVER PANTS**

Here at last, the trousers to match our Over Jacket. The waterproof trousers protect the angler's clothing from dirt and water when photographing Catfish. The trousers fold away to a very small size. Material: 100% Nylon, Polychloride coated. Gram weight: 70 g/m<sup>2</sup>

Code	Size	Colour
8987 001	L	black
8987 002	XL	black
8987 003	XXL	black
8987 004	XXXL	black



**NEW**

**T-SHIRT**

Material: 100% Cotton. Gram weight: 200 g/m<sup>2</sup>

Code	Size	Colour
8432 001	M	black
8432 002	L	black
8432 003	XL	black
8432 004	XXL	black
8432 005	XXXL	black



**DRYFIT SHIRT**

Smart shirt in quick-drying material. Ideal when hot summer temperatures bring you out in a sweat. Material: 100% Nylon (Dri Fit fabric). Gram weight: 180 g/m<sup>2</sup>

Code	Size	Colour
8930 001	M	yellow/black
8930 002	L	yellow/black
8930 003	XL	yellow/black
8930 004	XXL	yellow/black
8930 005	XXXL	yellow/black



**FLEECE JACKET**

Comfortable fleece pullover with tight-fitting hood in stylish Black Cat Design. The Special Fleece offers protection from the wind and cold. Material: 100% Polyester. Gram weight: 215 g/m<sup>2</sup>

Code	Size	Colour
8992 001	M	black/yellow
8992 002	L	black/yellow
8992 003	XL	black/yellow
8992 004	XXL	black/yellow
8992 005	XXXL	black/yellow



**RAIN JACKET**

Black Cat Outdoor Raincoat. Highly functional raincoat for all weather conditions. The outer material is breathable, water and dirt-resistant and dries very quickly. All zip fasteners are protected with waterproof rubber, while the hood moulds perfectly to the angler's head thanks to a bendable wire. The jacket has a lightweight design, making it the perfect companion for any time of year. Material: 100% Polyester. Gram weight: 130 g/m<sup>2</sup>

Code	Size	Colour
8994 001	M	black/yellow
8994 002	L	black/yellow
8994 003	XL	black/yellow
8994 004	XXL	black/yellow
8994 005	XXXL	black/yellow

kompletný cenník na [www.SPORTS.sk](http://www.SPORTS.sk), výhradný distribútor pre SR: SPORTS s.r.o.



**RAIN BIB'N'BRACE**

Black Cat Outdoor Rain Trousers. Highly functional trousers for all weather conditions. The outer material is breathable, water and dirt-resistant and dries very quickly. Neoprene protectors on the knee and buttock areas offer protection from external influences such as sharp stones, water and mud. All zip fasteners are protected with waterproof rubber. The trousers are of a lightweight design, making them the perfect companion for any time of year. Material: 100% Polyester. Gram weight: 130 g/m<sup>2</sup>



Code	Size	Colour
8995 001	M	black/yellow
8995 002	L	black/yellow
8995 003	XL	black/yellow
8995 004	XXL	black/yellow
8995 005	XXXL	black/yellow



**GUEST CHAIR II**

Ingenious solution for boat and bank anglers. A space-saving folding chair with reinforced adjustable backrest and comfortable, water-resistant seat. Material: 100% Polyester

Code	Width	Height	Depth	Content
9980 017	47 cm	48 cm	48 cm	1 pcs



**CROCHY CAP**

Material: 100% Acrylic. Gram weight: 500 g/m<sup>2</sup>

Code	Model	Content
9788 059	Visor	1 pcs
Trade Pack 5 Pieces		



**CROCHY CAP**

Material: 100% Acrylic. Gram weight: 500 g/m<sup>2</sup>

Code	Content
9788 058	1 pcs
Trade Pack 5 Pieces	



**CAP**

Material: 100% Cotton. Gram weight: 72 g/m<sup>2</sup>

Code	Model
9788 024	Black Cat
Trade Pack 5 Pieces	



**RAPPER CAP**

Material: 98% Cotton, 2% Spandex. Gram weight: 85 g/m<sup>2</sup>

Code	
9788 005	
Trade Pack 5 Pieces	



**SEAT SAVER**

Stylish car seat cover in modern BC design, suitable for all cars. Material: 100% Polyester

Code	Content	Colour
9906 001	1 pcs	black



**VISOR**

Material: 100% Cotton. Gram weight: 250 g/m<sup>2</sup>

Code	Colour
9788 002	black/yellow
Trade Pack 5 Pieces	



kompletný cenník na [www.SPORTS.sk](http://www.SPORTS.sk), výhradný distribútor pre SR: SPORTS s.r.o.





**BC UNIVERSAL BUCKET**

The Black Cat Bucket is an important accessory to have at the water. Whether you want to transport bait, small accessories or electronic items protected against dirt and moisture, the BC Bucket is the perfect option. The buckets can also be stacked and stands firm. Boat anglers in particular will come to love this packing option. The Black Cat Bucket is extremely durable. A grown man can easily stand on the bucket without damaging it. Material: 100% Polypropylene

Code	Length	Height	Depth	Colour	max.Weight
8514 001	38 cm	29 cm	29 cm	black	22 l

Trade Pack 5 Pieces



**BOWFLAG BLACK CAT**

Includes flag, pole, base plate and bag.

Code	Width	Height
9966 051	60 cm	260 cm



**CATFISH GLOVES**

Maximum grip coated landing glove. Prevents hand injuries. Delivered in a pair. Material: 30 % Polychloride, 55 % Nylon, 5 % Rubber, 10 % Cotton. Gram weight: 295 g/m<sup>2</sup>

Code
9790 005

Trade Pack 5 Pieces



**BLACK CAT DELUXE GLOVES**

Special catfish glove for landing fish and holding line when freestyle clonking, where the bait is retrieved by hand and the strike is also set by hand. The glove has a perfect fit, does not go brittle and is easily put on and removed even when wet. Material: 90% Neoprene, 10% Nylon. Gram weight: 2,5 g/m<sup>2</sup>

Code	Size
9790 006	L
9790 007	XL

Trade Pack 5 Pieces



**BLACK CAT CHUNKS**

Highly attractive catfish boilie. Thanks to its huge dimensions the boilie is highly distinctive and stays on the rig for long periods while pellets, for example, need replacing more often. Strong smelling ingredients attract the barbel hunters to the bait from great distances. The aroma has been optimised during prolonged testing by the Black Cat Team. A genuine alternative to deadbaits and pellets.

Code	Ø	Contents
3939 001	50 mm	3 kg

Trade Pack 3 Pieces



**MONSTER MULLET**

Finally it is available, the Mega Boilie, especially designed for Catfish. Made of a mixture of several liver and blood meals in conjunction with fish extracts, it attracts the giant predators over huge distances. The catches will surprise you!

Code	Ø	Contents
3939 002	50 mm	3 kg

Trade Pack 3 Pieces



**BLACK CAT DIP**

The matching dip for Black Cat Chunks, with a base of strong smelling extracts with aromas of blood, meat and liver – perfect for giving Black Cat Chunks or catfish pellets an additional boost. Particularly pasty and binding for lasting attraction.

Code	Contents
3939 020	150 ml

Trade Pack 6 Pieces



**BLACK CAT ROD DISPLAY**

Code	Width	Height	Depth
9963 507	60 cm	105 cm	43 cm



**BLACK CAT MEASURING TAPE**

Length: 10m. Flexible, yet extremely durable. Measures any catfish in no time at all.

Code
9890 011

Trade Pack 5 Pieces



**BLACK CAT LANYARD  
KEYCHAIN**

Lanyard to prevent any objects from being lost in the water.

Code  
9949 006  
Trade Pack 10 Pieces

**STICKER BLACK CAT**

Code    Width    Height  
9949 008    21,0 cm    14,8 cm  
Trade Pack 10 Pieces

**BLACK CAT CATFISH  
STICKER**

Code    Width    Height  
9949 033    8,0 cm    7,0 cm

**BATTLE CAT STICKER**

Code    Width    Height  
9949 031    12 cm    8 cm  
Trade Pack 10 Pieces

**BLACK CAT STICKER**

Code    Width    Height  
9949 036    14,5 cm    9,5 cm  
Trade Pack 10 Pieces

**BLACK CAT STICKER**

Special high-tech boat sticker with certified seawater resistance. Highly UV-resistant thanks to the use of screen printing. The UV resistance lasts several years depending on use and the intensity of the actual radiation. Material: Polychlorid adhesive film, P4 polyacrylate high-tech adhesive with certified seawater resistance

Code    Width    Height  
9949 052    119 cm    45 cm

**BLACK CAT FLAG**

Material: 100% Nylon

Code    Width    Height  
9963 512    150 cm    80 cm

**TIE HOOK**

Code    Length    Contents    Colour  
9901 000    50 mm    1 pcs    silver  
Trade Pack 5 Pieces





**BROWNING**  
FISHING

**Perfect angling equipment and accessories for  
champion anglers of the present and future. Place your trust  
in the experience of a global brand whose equipment  
is synonymous with quality and winning championships.**



kompetný canník na [www.SPORTS.sk](http://www.SPORTS.sk), výhradný distribútor pre SR: SPORTS s.r.o.





Match Poles.....	Page B 4-19	Particles & Aromas, Accessories .....	Page B 88-95
Carp Power Poles.....	Page B 20-25	Lines.....	Page B 95-97
Kits & Extensions .....	Page B 26-27	Hooks.....	Page B 98-101
Margin and Starter Poles.....	Page B 28-35	Method Feeder .....	Page B 102-110
Tele Rods .....	Page B 36-37	Lead and Accessorie .....	Page B 111-112
Bolo Rods .....	Page B 38-39	Weights and Accessories.....	Page B 113-114
Feeder Rods.....	Page B 40-41	Pole Accessories.....	Page B 115-120
Match Rods .....	Page B 42-45	Seatboxes & Accessories .....	Page B 121-136
Feeder Rods.....	Page B 44-59	Buckets, Baitboxes & Riddles.....	Page B 137-139
Match Rods .....	Page B 60-61	Pole Rollers, Kit Roosts, Rests.....	Page B 140-141
Feeder Rods.....	Page B 62-65	Luggage, Tubes & Umbrellas.....	Page B 142-157
Reels.....	Page B 66-79	Keep Nets, Landing Nets, Net Handles .....	Page B 158-166
Rod Accessories.....	Page B 80-81	Clothing .....	Page B 167-173
Groundbait .....	Page B 82-88	Promotional items.....	Page B 174

## Browning Poles – nobody does it better !

Browning is at the forefront of pole design. Our design team combines high levels of expertise in carbon manufacturing with practical “real world” experience of what anglers actually need from a pole. All Browning pole models are extensively tested “on the bank” before release onto the market so are proven and reliable products.

All Browning poles incorporate a host of “common sense” features that make pole buying, setup and ownership easy.

Browning poles share mandrels, therefore have a high level of section compatibility across the ranges and models. Future upgrades are convenient and easy.

## SPHERE ZERO-G

Sphere Zero-G poles are the pinnacle of pole design and construction. Like Browning’s Sphere rods, they represent the very best product we can achieve using the carbon technology currently available. Every aspect of a Sphere pole has been optimized – from the specially designed topkits to the ergonomic butt sections. These are specialist poles designed for skilled pole anglers who have the experience to use the ultra high performance to give them competitive advantage.



Xitan Advance poles are flagship products in the Browning range. These are professional standard poles for anglers looking top performance, top quality and total reliability. All Xitan poles are deliberately designed to be long lasting and stronger than the typical “top-end” pole. They can be used with confidence for all forms of fishing. They share a number of innovative and advanced features that are unique to Browning poles which make owning and fishing with a Xitan pure pleasure.

## 2eX-S

Our exciting 2eX-S mid-range poles share the same advanced features found on our Xitan poles – but at prices to suit all budgets. These are strong and durable “all-rounders” that will give many years of reliable service. No other pole range offers such levels of performance, quality and features at these prices.

## SILVERLITE

Our Silverlite poles are purpose designed for situations where ultimate performance is more important than ultimate strength. These are ultra stiff, light weight and “fast” poles. They are aimed at experienced anglers who are willing to accept some compromise on the pole’s strength in return for lighter weight and increased stiffness. They have a range of advanced features specifically designed for “silverfish” angling.

## BLACK Magic

The Black Magic name has always been synonymous with strength and durability, and the poles bearing this famous name continue this tradition. Poles in the Black Magic range are built alongside and to the same quality high standards as our Xitan and 2eX-S poles. These are not the typical low-cost poles – they are pure magic!

### Spares Service

Browning keeps large stock of spare parts for all current and many discontinued poles. We aim to keep prices reasonable and can offer a rapid delivery service. We operate a consumer helpline (poles@zebco-europe.com). Enquiries are answered by our service team and sales are directed to the consumer’s nearest Browning stockist.

# What makes BROWNING poles special?

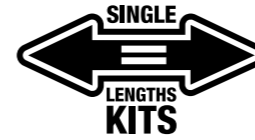

### Single Length Kits – no cutting back, no bushes, just add elastic and you’re fishing!

Single Length Kits – no cutting back, no bushes, just add elastic and you’re fishing! All Xitan SLK topkits are the same length and are pre-fitted with top-quality PTFE bushes, so no more cutting or lost pole length. We offer 4 types of SLK (Standard, Extra Power, Short and Long) with different tip diameters to suit different sizes of elastic. There are also matching length cupping kits with screw attachments fitted. At last, no need to take a saw to your new pole.



### Pole Protection System – protect sections from damage

Pole Protectors are purpose designed short butt sections. Each of the Protectors is designed as an integral part of the pole and has built-in skid bungs. There are purpose designed Protectors for each pole range and they fit every section from the 5th through to the 16m butt sections. They protect the main sections (particularly useful on thin walled middle sections) and give useful length options.



### Nano-Carbon Construction – strong and light, but not brittle

The high-modulus carbon needed to make a pole light and stiff can often be brittle. The pole is strong but a “knock” against something hard or dropping a section can result in breakage. We use Nano-carbon fibres, which makes the sections much more durable!



### At last – no cutting back

Xitan poles do not need any cutting back for even the largest elastics so no waste or lost length.



### Overwrapped Joints – designing out wear

The top-end Xitans have carbon overwrapped male and female joints to resist premature wear and chipping. The overwrap on the female joints also increases hoop strength which helps unshipping when the pole is under load.



### Section Alignment Points – for maximum stiffness

All sections have alignment arrows for maximum rigidity. Sections are also numbered for identification and carry a part number so if you need to order a replacement you will always get the correct section.



### Strengthened Stress Points – designing out weak spots

Xitans have visibly strengthened grip areas on the middle sections and also on the elbow areas of the butt sections. These resist crushing when unshipping and cracking when striking. They look good too!



### Diamond Surface Finish – smooth and fast shipping

Xitan pole sections have a special diamond ground surface finish for easy “non-stick” shipping in and out. Wet or dry, the Xitans are very “fast” poles to fish with. We also use the minimum of paint to reduce weight and minimise “sticky” areas on butt sections.

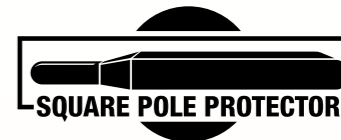

### Square Pole Protector

Ergonomically shaped Pole Protectors formed by using a carbon process unique to pole making. These sections make fishing at long lengths very comfortable, in addition to protecting the sections from end damage.



### Precision Points – accurate feeding is important to success

The butt sections of all Xitan poles have a series of full diameter markings which allow consistent and accurate fishing and feeding when using a pole cup.



### Premium Protection Tubes

Xitan poles and SLK topkits are supplied in premium quality protective tubes. These resist both cracking in low temperatures and distortion in high temperatures. Your valuable pole deserves the best protection available.



### Tactile Precision Points

Special raised areas on Sphere butt sections that can be felt when shipping out. Fish accurately an feel the end of the butt sections without looking down!

Browning Trademarks Licensed From Browning.

Pole weight specifications do not include possible extensions such as Pole Protectors or Mini Extensions.





## SPHERE ZERO-G F1 plus+



Code	Model	Length	Sections	Tr.-Length	Weight
10211 130	Pole	13,00 m	8	1,80 m	760 g
10211 133	Set 13 m Cont.	13,00 m	8	1,80 m	760 g
10211 162	Set 17 m UK	17,00 m	10	1,80 m	1289 g
10211 998	Extension 14,5 m	1,80 m	1	1,80 m	260 g
10211 999	Extension 16 m	1,80 m	1	1,80 m	260 g
10211 987	Pole Protector 6/7	1,00 m	1	1,00 m	155 g
10211 989	17 m Extender Section 1 m	1,00 m	1	1,00 m	225 g
10211 991	Multi Kit 3,9/4,5 mm	2,50 m	2	1,75 m	39 g
10211 992	Cupping Kit 2,50 m	2,50 m	2	1,30 m	39 g
10211 996	Kit 4/1 3,9/4,5 mm	5,45 m	4	1,75 m	162 g

### +++SET KIT CONFIGURATION+++

Code	Model	Cup. Kit	Short C	Kit 4/1	Kit 2/1	Pole Prot.	C Section	D Section
10211 133	Set 13 m Cont.	1	1	2	2	1	-	-
10211 162	Set 17 m UK	1	2	-	13	3	2	1

## Sphere Zero-G F1 Plus

Sphere Zero-G F1 plus – A professional level pole for professional level anglers

The Sphere Zero-G F1 plus is the lightest and stiffest pole that has ever been bought to the market. Each Sphere pole is hand made from the highest quality Japanese carbon, with grades carefully selected to provide the optimal balance between pole weight, stiffness and strength. The pole is both stiffer and significantly lighter than typical flagship poles. This is an outstanding, professional level competition pole that has been designed for skilled pole anglers who want the very best, and have the experience to use its ultra high performance to give them a competitive advantage.

We do not specify an elastic rating as this is no real measure of a pole's strength. Used correctly the Sphere pole is adequately strong for all typical match fishing situations where a conventional top-end pole would be used.

The Sphere Zero-G also introduces a number of innovations including

- the "Multikit", a new design of topkit that can be used as a 2.5m conventional kit, or as a 1.75m one piece kit, without loss of pole length
- the "SEPP"s, a special versions of our unique Square Pole Protector sections which make fishing at long lengths and in windy conditions comfortable and stable.
- "Tactile Precision Points" these are raised areas on the butt sections that can be felt when the pole shipping out. They allow accurate fishing without looking down for painted lines, and act as a "stop" by marking the end of the pole.
- The "Extender", a 1m long, full quality, butt section that can be used to extend the pole to 17m, or to give different length options when fishing to features or islands etc.

Sphere Zero-G F1 Plus key features

- The choice for experienced, professional level competition anglers who demand the best
- Made with the highest quality Japanese carbon currently available with internal reinforcing on key sections.
- A true 16m+ pole "ready to fish" when combined with the ergonomic square Pole Protector
- Ultra light and ultra stiff, with performance that does not deteriorate even at full length
- Ground surface finish and minimal matt paint for fast and easy shipping in all conditions
- Supplied with Browning's Ergonomic Pole Protectors (SEPPs) for comfort and stability in windy conditions
- Carbon banded female joints, plus over-wrapped male joints on high-wear sections
- Supplied with pre-bushed Sphere Multikits fitted with a unique Duo-bush allowing a choice of tip size
- The Sphere Zero-G has conventional length butt sections of 1.85m
- Fully section compatible with Silverlite poles top 3 section compatible with all Xitan poles







**NEW**

Code	Model	Length	Sections	Tr-Length	Weight
10215 110	Sphere Zero-G Power Partner	10,50 m	7	1,75 m	645 g



## Sphere Zero-G Power Partner

Browning's Sphere Zero-G Partner Pole provides Sphere pole owners with a fully section compatible 10.5m pole ideal for any situation needing some extra strength. Ideal for margin fishing, as a back-up pole - or just for general summer fishing at shorter lengths. Made of Sphere quality carbon so is very stiff and weighs only 645gr at 10,50m. Can be safely used with the Sphere butt sections and fished at longer lengths. The Power Partner is supplied "pole only", but is fitted with a Sphere multikit. It's a "must have" for any Sphere owner!



**NEW**

Code	Model	Length	Sections	Tr-Length	Weight
10216 115	Sphere Zero-G Power Perfection	11,50 m	7	1,75 m	655 g
10216 116	Set 11,50 m	11,50 m	7	1,75 m	655 g
10216 996	Multi Kit L 2/1, 4,5 mm Duo Bush	2,75 m	2	1,75 m	43 g
10216 905	D Section	1,60 m	1	1,60 m	79 g
10216 997	Kit 3/1	4,15 m	3	1,75 m	97 g
10216 992	Multi Cupping Kit	2,75 m	2	1,75 m	47 g



## Sphere Zero-G Power Perfection

Browning's Sphere Zero-G Power Perfection is designed for anglers who want a top quality, high-performing pole, but at a shorter length. It is "perfection" for competitions fished to a 11.5m length limit, or where pole performance is more important than length.

Sphere Zero-G Power Perfection key features

- The choice for experienced, professional level competition anglers who demand the best
- Made with the highest quality Japanese carbon currently available with internal reinforcing on key sections.
- A true 11.5 pole "ready to fish" when combined with the supplied Pole Protector
- Ultra light and ultra stiff, with performance that does not deteriorate even at full length
- Ground surface finish and minimal matt paint for fast and easy shipping in all conditions
- Carbon banded female joints, plus over-wrapped male joints on high-wear sections
- Supplied with pre-bushed Sphere Multikits fitted with a unique Duo-bush allowing a choice of tip size
- Fully section compatible with Silverlite poles top 3 section compatible with all Xitan poles

### +++SET KIT CONFIGURATION+++

Code	Model	Multi Kit	Kit 3/1	Cup. Kit	Pole Prot.
10216 116	Set 11,5 m	1	1	1	1



kompletný ceník na [www.SPORTS.sk](http://www.SPORTS.sk), výhradný distribútor pre SR: SPORTS s.r.o.



## XITAN Z14-1 ADVANCE

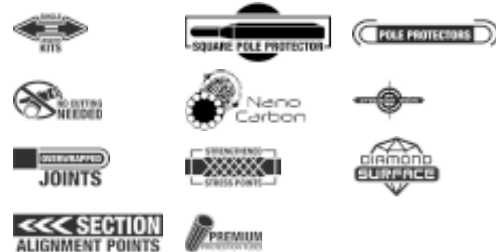

Code	Model	Length	Sections	Tr.-Length	Weight
1896 133	Pole	13,00 m	8	1,95 m	830 g
1896 134	Set 13 m Cont.	13,00 m	8	1,95 m	830 g
1896 164	Set 16,80 m Commercial Special	16,80 m	10	1,95 m	1410 g
1896 998	Extension 14,5 m	1,95 m	1	1,95 m	270 g
1896 999	Extension 16 m/17,5 m	1,95 m	1	1,95 m	320 g
1896 997	Kit 4/1 3,9 mm	5,90 m	4	1,50 m	164 g

### +++SET KIT CONFIGURATION+++

Code	Model	Cup. Kit	1/1 piece Kit	Power C	4/1 Kit	2/1 Kit	Pole Prot.	Short C
1896 133	Set 13 m Cont.	1	-	-	2	1	1	-
1896 164	Set 16,80 m Commercial Special	1	7	2	-	-	3	-



## Xitan Z14-1 Advance

Xitan Advance Z14-1 – The longest and strongest flagship pole available

Following in the footsteps of our famous Xitan Z12, the Z14-1 set a new performance standard with its fine balance of rigidity, weight and market leading strength. Constructed using a new type of Silica Reinforced Carbon and resin, the Z14-1 has built a deserved reputation as a totally reliable, strong and durable competition pole – a long lasting pole that will do everything and anything asked of it. The Z14-1 has been designed as a true length 16m pole - without needing mini-extensions, or “cheating” by fitting unusable extra-long topkits, to reach full length. This is the longest pole available on the market, and can be further extended to 18m+. When used with the Xitan, 2m 1 piece topkit the Z14-1 still reaches a true 16m – and is even stiffer and lighter – making it the ultimate commercial carp pole.

### Z14-1 Key features

- The first choice for the serious competition angler requiring a true length and ultra reliable, pole
- A true 16m pole “ready to fish” without the need for a mini-extension. The longest pole available!
- Silica reinforced Nano-carbon provides unrivalled balance of weight, rigidity and market leading strength.
- Light and ultra stiff, with perfect balance and response at all lengths. Fishable to lengths of 18m plus
- Supplied with Browning’s unique and “elbow friendly” Square Pole Protectors (SQPPs)
- Carbon over-wrapped male & female joints on all sections to strengthen and minimise wear
- Carbon reinforced “grip” areas on lower sections at the most common breakage area
- Supplied with pre-bushed Single Length Kits fitted with a unique Duo-bush allowing a choice of tip size
- Pulla kits fitted with an innovative directional PTFE bush - ultra-smooth operation without moving parts.
- 1 piece 2m topkit option available for modern commercial carp styles - extra stiff and greater control of fish
- The Xitan Z14-1 has longer length butt sections of 2m to optimise the pole stiffness and length
- Elastic rating 14/20, with a low-cost additional power C/3 section available for more demanding fishing

## XITAN Z9-2 ADVANCE



Code	Model	Length	Sections	Tr.-Length	Weight
10801 130	Pole	13,00 m	8	1,75 m	825 g
10801 133	Set 13 m Cont.	13,00 m	8	1,75 m	825 g
10801 162	Set 16 m UK	16,00 m	10	1,75 m	1385 g
10801 998	Extension 14,5 m	1,75 m	1	1,75 m	260 g
10801 999	Extension 16 m	1,75 m	1	1,75 m	300 g
10801 987	Xitan 17 m Extender Section 1.00m	1,15 m	1	1,15 m	200 g
10801 996	Kit 4/1, 4,5 mm	5,90 m	4	1,59 m	175 g

### +++SET KIT CONFIGURATION+++

Code	Model	Cup. Kit	1/1 piece Kit	Power C	4/1 Kit	2/1 Kit	Pole Prot.	Short C
10801 133	Set 13 m Cont.	1	-	-	2	1	2	-
10801 162	Set 16 m UK	1	-	2	-	9	3	1

## Xitan Z9-2 Advance

Xitan Advance Z9-2 - A famous name reborn using the latest developments in carbon technology

The Xitan Z9-2 pole has been engineered using the very latest and highest grade carbons available to us. When combined with Browning’s long experience of pole design, these “state of the art” materials have allowed us to produce a truly “top-end” pole that is perfectly balanced and remarkably light in weight, but also has the reserves of strength and durability essential for modern pole fishing styles - and for the large fish that are now a part of competition fishing. This is a serious pole for serious match anglers who expect total reliability from their equipment. This pole will not let you down, and will provide top level performance .... all the way to 17 meters and beyond. The pole incorporates the latest advanced Xitan features

Browning’s first Z9 pole became a legend ... the Z9-2 will take the pole’s reputation to a new level!

### Z9-2 Key features

- The first choice for anglers requiring truly “top end”, market leading, performance
- Carefully designed to give the optimum balance between weight, strength and rigidity.
- Very light, ultra stiff, with perfect balance and response at all lengths to 17m plus
- Suitable for professional level competition fishing, including match carp fishing
- Supplied with Browning’s unique and “elbow friendly” Square Pole Protectors (SQPPs)
- Carbon over-wrapped male & female joints on all sections to strengthen and resist wear
- Carbon reinforced “grip” areas on lower sections at the most common breakage area
- Supplied with pre-bushed Single Length Kits fitted with a unique Duo-bush allowing a choice of tip size
- Pulla kits fitted with an innovative directional PTFE bush - ultra-smooth operation without moving parts
- The Xitan Z9-2 has conventional length butt sections of 1.85m
- Fully section compatible with current and previous Xitan Power poles
- Elastic rating 14/20, with a low-cost additional power C/3 section available for more demanding fishing

NEW

### Xitan Power Upgrade Pack

Upgrade pack suitable for all Xitan poles which provides extra strength when needed, and for margin fishing. Comprises 1x extra-strength Xitan C/3 and D/4 sections, plus 4 large bore Xitan SLK Power topkits.

<b>Code</b>	<b>Model</b>
10409 990	Xitan Power Upgrade Pack





Code	Model	Length	Sections	Tr.-Length	Weight
10802 130	Pole	13,00 m	8	1,75 m	891 g
10802 133	Set 13 m Cont.	13,00 m	8	1,75 m	891 g
10802 162	Set 16 m UK	16,00 m	10	1,75 m	1481 g
10802 998	Extension 14,5 m	1,75 m	1	1,75 m	290 g
10802 999	Extension 16 m	1,75 m	1	1,75 m	300 g
10802 996	Kit 4/1, 4,5 mm	5,90 m	4	1,59 m	175 g

### +++SET KIT CONFIGURATION+++

Code	Model	Cup. Kit	1/1 long Kit	Power C	4/1 Kit	2/1 Kit	Pole Prot.	Short C
10802 133	Set 13 m Cont.	1	-	-	2	1	2	-
10802 162	Set 16 m UK	1	-	1	-	7	3	1



## Xitan Z8-2 Advance

Xitan Advance Z8-2 – The ultimate “all-round” pole incorporating our latest innovation & technology

The first generation Xitan Power Z8 was one of Browning's best selling poles with a hard won reputation as a high performing, strong and very reliable “all rounder”. This theme has been developed further with the totally new Xitan Advance Z8-2. Careful use of the latest carbon technology has resulted in a pole which is both lighter and stiffer than its predecessor, but without sacrificing any of the strength the Z8 has always been famous for. Remarkably stiff and light, yet tough and very long-lasting, this pole that will do everything that is asked of it – over many years of hard use. The Z8-2 incorporates all of the same advanced features found on the most expensive Xitans and offers unrivalled quality and performance in its price range.

### Z8-2 Key features

- The perfect choice for anglers requiring a top performing pole with higher levels of strength and durability
- Built to the same quality standards as the top-end Xitan Z14 & Z9, but using different carbon grades
- Light, stiff, well balanced and very responsive at all lengths to a genuine 16 metres.
- Suitable for all styles of pole fishing including more demanding styles of match carp fishing
- Supplied with Browning's unique and “elbow friendly” Square Pole Protectors (SQPPs)
- Carbon over-wrapped male & female joints on all sections to strengthen and minimise wear
- Carbon reinforced “grip” areas on lower sections at the most common breakage area
- Supplied with pre-bushed Single Length Kits fitted with a unique Duo-bush allowing a choice of tip size
- Pulla kits fitted with an innovative directional PTFE bush - ultra-smooth operation without moving parts
- The Xitan Z8-2 has conventional length butt sections of 1.85m
- Elastic rating 14/20. Fully section compatible with current and previous Xitan Power poles



Code	Model	Length	Sections	Tr.-Length	Weight
10409 130	Pole	13,00 m	8	1,75 m	902 g
10409 133	Set 13 m Cont.	13,00 m	8	1,75 m	902 g
10409 162	Set 16 m UK	16,00 m	10	1,75 m	1492 g
10409 998	Extension 14,5 m	1,75 m	1	1,76 m	290 g
10409 999	Extension 16 m	1,75 m	1	1,77 m	300 g
10409 996	4/1 Kit 5,5 mm	5,90 m	4	1,60 m	178 g

### +++SET KIT CONFIGURATION+++

Code	Model	Cup. Kit	1/1 long Kit	C Section	4/1 Kit	2/1 Kit	Pole Prot.
10409 133	Set 13 m Cont.	1	-	-	2	1	2
10409 162	Set 16 m UK	1	-	1	-	7	3

## Xitan Z7-2 Power Special

Xitan Advance Z7-2 Power Special – Strength and durability in excess - without excess weight!

Browning's Xitan Advance Z7-2 has been purpose designed for anglers who need a stronger-than-normal high performance pole, but are only willing to accept minimal extra weight and loss of stiffness. To achieve this the Z7-2 lower and middle sections, which absorb the most pressure when catching big hard fighting fish, have been specially strengthened and reinforced. However, the larger sections and butts still use very high modulus carbon similar to the other Xitan poles. This unique design has had made the Z7-2 much stiffer and lighter than traditional “power” poles. The result is a high performing, very strong, pole without equal in the “power pole” market which is perfect for any situation – lakes or rivers – that needs extra strength.

### Z7-2 Key features

- The first choice for anglers needing a top quality and very strong pole, but with minimal extra weight
- Built to the same quality standards as other Xitan poles, but with special carbon reinforcing to add extra strength
- Lighter and stiffer than traditional “power” poles. Well balanced and easily fishable to a genuine 16 metres.
- Suitable for every style of fishing, the most demanding situations, the biggest fish and most difficult conditions.
- Supplied with Browning's unique and “elbow friendly” Square Pole Protectors (SQPPs)
- Carbon over-wrapped male & female joints on all sections to strengthen and minimise wear
- Carbon reinforced “grip” areas on lower sections at the most common breakage area
- Supplied with large bore, pre-bushed, Single Length Kits which accept the heaviest elastics without cutting.
- The Xitan Z7-2 has conventional length butt sections of 1.85m
- Elastic rating 20+. Fully section compatible with current and previous Xitan Power poles



NEW

### Xitan Pro 17 m Upgrade Pack

Upgrade pack which extends all Xitan poles to 17m (to 18m for Z12 & 14). Comprises a special 1m extension which fits 14.5 & 16m sections, plus 2 x 3.9mm/4.5mm Xitan SLK Duokits.

<b>Code</b>	<b>Model</b>
10801 990	Xitan Pro 17 m Upgrade Pack



## XITAN XTREME MARGIN 9.5m



Code	Model	Length	Sections	Tr.-Length	Weight
1885 950	Pole	9,50 m	6	1,75 m	475 g
1885 952	Set 9,5 m	9,50 m	6	1,75 m	475 g

### +++SET KIT CONFIGURATION+++

Code	Model	2/1 Kit	Pole Prot.
1885 952	Set 9,5 m	2	1

## Xitan Xtreme Margin 9.5 m Revolution

Xitan Xtreme Margin 9.4m – The fully compatible margin pole partner for our Xitan range. Browning's Xitan Xtreme Margin is, as the name suggests, a high quality and very strong pole for margin and "short" fishing. All sections have increased wall strength and visible reinforcing, yet the Xtreme Margin still weighs less than 500gr at 8.5m! – making it probably the lightest margin pole available. Every section of the Xtreme Margin is fully compatible with all current and previous Browning Xitan poles so it is the perfect summer partner other poles in the Xitan range.

### Xtreme Margin Key features

- The first choice for anglers needing a very strong, but remarkable light, margin or "short" pole
- Fully section compatible, so the perfect partner to other Browning Xitan poles
- Built to the same quality standards as other Xitan poles with special carbon reinforcing to add extra strength
- Supplied with a special Pole Protector section which fits the pole at 7 & 8.5m.
- Supplied with large bore, pre-bushed, Single Length Kits which accept the heaviest elastics without cutting.
- Elastic rating 20+. Fully section compatible with current and previous Xitan Power poles

## Champion's Choice SILVERLITE SL 10-12 13



Code	Model	Length	Sections	Tr.-Length	Weight
10201 130	Pole	13,00 m	8	1,80 m	791 g
10201 132	Set 13 m	13,00 m	8	1,80 m	791 g
10201 162	Set 16 m	16,00 m	10	1,80 m	1389 g
10201 998	Extension 14,5 m	1,75 m	1	1,80 m	270 g
10201 999	Extension 16 m	1,75 m	1	1,80 m	328 g
10201 988	Adjusta Section II fits 14.5/16 m	1,00 m	1	1,00 m	170 g
10201 989	Adjusta Section I 10-12 13 m	1,00 m	1	1,00 m	157 g
10201 997	Kit 4/1 3,9 mm	5,70 m	4	1,60 m	153 g
10201 992	Kit 2/1 3,0 mm	2,75 m	2	1,60 m	31 g
10201 993	Kit 2/1 3,9 mm	2,75 m	2	1,60 m	31 g
10201 991	Cupping Kit 2/1 2,70 m	2,75 m	2	1,40 m	33 g

### +++SET KIT CONFIGURATION+++

Code	Model	Top Kits	Cup. Kit	Kit 4/1	Power C	Pole Prot.
10201 132	Set 13 m	-	1	2	-	-
10201 162	Set 16 m	7	1	-	1	2

## CC Silverlite SL 10-12

Silverlite Competition Poles - for when ultimate performance is more important than ultimate strength. In recent years poles have needed to become increasingly strong to cope with the large fish now commonplace in most lakes and rivers. However, extra strength invariably means extra weight, therefore the latest generation of poles are also heavier than their predecessors. Browning has recognised that not all anglers want or need a "power" pole. Many anglers still mainly target "silverfish" & F1s, therefore a light weight, ultra stiff and "fast" pole is more suitable and desirable than ultimate strength. Our Silverlite poles have been purpose designed for this type of fishing and are considerably lighter and stiffer than their "power" pole equivalents. They share many of the advanced features found on our market leading Xitan poles.

### However, the Silverlites have some unique features specifically designed for this type of pole:

- Pre-bushed, 2 piece, topkits available with 3mm and 3.9mm tip diameters to suit light solid and medium hollow elastics
- The complete topkit is 2.75m long so correct for light hollow elastics running through both sections. The 2nd sections have reinforced bands so can be drilled to convert to side pulla kits.
- The topkit tip sections are 1.6m long so perfect for use with light solid elastics running through the tip section only, and a convenient length for breaking down at when fishing in very shallow water.
- The top sections are available separately and provide a low cost way of having a range of light elastic grades available and ready for use.
- The poles are supplied with an "Adjusta" Pole Protector section that can easily be cut to length to make the pole exactly 13m long.
- The Silverlite topkits and 3rd section are compatible (including length) with all Browning Xitan poles. The Silverlites are aimed at experienced pole anglers who want the performance benefits of light weight and increased stiffness, but also understand and are willing to accept some compromise on the pole's strength.





## Champion's Choice SILVERLITE SL 10-08 13



Code	Model	Length	Sections	Tr.-Length	Weight
10200 130	Pole	13,00 m	8	1,80 m	819 g
10200 132	Set 13 m	13,00 m	8	1,80 m	814 g
10200 147	Set 14,5 m	14,50 m	9	1,80 m	814 g
10200 998	Extension 14,5 m	1,75 m	1	1,75 m	280 g
10200 999	Extension 16 m	1,75 m	1	1,75 m	291 g
10200 997	Kit 4/1 3,9 mm	5,70 m	4	1,60 m	155 g

### +++SET KIT CONFIGURATION+++

Code	Model	Kit 2/1	Cup. Kit	Kit 4/1	Uni-C	Pole Prot.
10200 132	Set 13 m	-	1	2	-	-
10200 147	Set 14,50 m	5	1	-	1	2

### CC Silverlite SL 10-08

Silverlite Competition Poles - for when ultimate performance is more important than ultimate strength. In recent years poles have needed to become increasingly strong to cope with the large fish now commonplace in most lakes and rivers. However, extra strength invariably means extra weight, therefore the latest generation of poles are also heavier than their predecessors. Browning has recognised that not all anglers want or need a "power" pole. Many anglers still mainly target "silverfish" & F1s, therefore a light weight, ultra stiff and "fast" pole is more suitable and desirable than ultimate strength. Our Silverlite poles have been purpose designed for this type of fishing and are considerably lighter and stiffer than their "power" pole equivalents. They share many of the advanced features found on our market leading Xitan poles.

However, the Silverlites have some unique features specifically designed for this type of pole:

- Pre-bushed, 2 piece, topkits available with 3mm and 3.9mm tip diameters to suit light solid and medium hollow elastics
- The complete topkit is 2.75m long so correct for light hollow elastics running through both sections. The 2nd sections have reinforced bands so can be drilled to convert to side pulla kits.
- The topkit tip sections are 1.6m long so perfect for use with light solid elastics running through the tip section only, and a convenient length for breaking down at when fishing in very shallow water.
- The top sections are available separately and provide a low cost way of having a range of light elastic grades available and ready for use.
- The poles are supplied with an "Adjusta" Pole Protector section that can easily be cut to length to make the pole exactly 13m long.
- The Silverlite topkits and 3rd section are compatible (including length) with all Browning Xitan poles. The Silverlites are aimed at experienced pole anglers who want the performance benefits of light weight and increased stiffness, but also understand and are willing to accept some compromise on the pole's strength.

## Champion's Choice SILVERLITE SL 10-06 13



Code	Model	Length	Sections	Tr.-Length	Weight
10210 130	Pole	13,00 m	8	1,75 m	819 g
10210 133	Set 13 m Cont.	13,00 m	8	1,80 m	819 g
10210 134	Set 13 m	13,00 m	8	1,80 m	819 g
10210 998	Extension 14,5 m/16 m	1,75 m	1	1,75 m	323 g
10210 904	Sphere/Silverlite Uni C Section	1,51 m	1	1,51 m	48 g
10210 989	Adjusta Section I 10-06 13 m	1,00 m	1	1,00 m	163 g
10210 997	Kit 4/1 3,9 mm	5,70 m	4	1,60 m	147 g

### +++SET KIT CONFIGURATION+++

Code	Model	Top Kits	Cup. Kit	Kit 4/1	Uni-C	Pole Prot.
10210 133	Set 13 m Cont.	-	1	2	-	-
10210 134	Set 13 m	5	1	-	1	1

### CC Silverlite SL 10-06

Our Silverlite 10-12 and 10-08 poles have been a major success due to their incredible rigidity and balance. Therefore we have extended the range to include a lower cost version so more anglers can enjoy the Silverlite "magic". The 10-06 includes all the advanced Silverlite features and technology. Like the more expensive models, it is stiffer and lighter than typical poles in this price range. A side benefit of the slightly lower carbon grades used for the 10-06 is that the pole is a little stronger than its more expensive brothers, so it's a good choice for anglers needing a little extra strength in a "silverfish" pole - perhaps for catching "F1's", or river fishing with big floats. The Silverlite SL 10-06 is sold at 13m with optional extensions to extend the pole up to 16m.





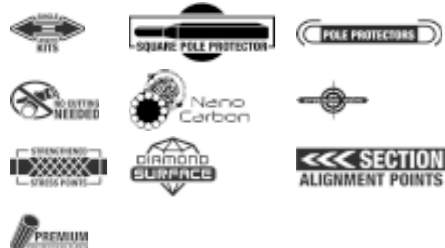

Code	Model	Length	Sections	Tr.-Length	Weight
10203 133	Pole + Pole Protector	13,00 m	8	1,75 m	846 g
10203 134	Set 13 m	13,00 m	8	1,75 m	846 g
10203 162	Set 16 m	16,00 m	10	1,75 m	1436 g
10203 999	Extension 14,5/16 m	1,75 m	1	1,75 m	295 g
10203 996	Kit 4/1 3,9 mm	5,90 m	4	1,60 m	170 g

### +++SET KIT CONFIGURATION+++

Code	Model	Kit 4/1	Top Kits	Cup. Kit	Uni-C	Pole Prot.
10203 134	Set 13 m	2	-	1	-	2
10203 162	Set 16 m	-	5	1	1	1

## 2eX-S 60#1

Top of the 2eX-S range, the 60#1 is designed to provide optimal balance between pole weight and strength so is perfect for all pole fishing styles – big fish or small. High quality carbon ensures the pole is light, stiff and strong all the way to 16 metres. The 60#1 has been benchmarked and compares favourably with many poles of twice the price. Built alongside, and to the same high quality standards, as our top-end Xitan poles. Visibly reinforced at all section stress points, with overwrapped joint areas to resist wear, guaranteeing both strength and long life. 2eX-S poles are “ready to fish” with pre-bushed topkits, so no cutting back and lost length - just add elastic and go fishing! Elastic rating 16. Supplied with our revolutionary Square Pole Protector section for easy and comfortable fishing at long lengths - no more “elbow pain” !

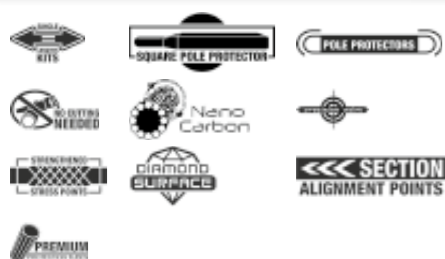

Code	Model	Length	Sections	Tr.-Length	Weight
10204 133	Pole + Pole Protector	13,00 m	8	1,75 m	887 g
10204 134	Set 13 m Cont.	13,00 m	8	1,75 m	887 g
10204 162	Set 16 m	16,00 m	10	1,75 m	1477 g
10204 999	Extension 14,5/16 m	1,75 m	1	1,75 m	295 g

### +++SET KIT CONFIGURATION+++

Code	Model	Kit 4/1	Top Kits	Cup. Kit	Uni-C	Pole Prot.
10204 134	Set 13 m	2	-	1	-	2
10204 162	Set 16 m	-	5	1	1	1

## 2eX-S 50#1

Top performance and value at this popular price point. A careful mix of carbon grades has allowed us to keep the cost down, but very little has been sacrificed in keeping the pole light and stiff when compared to much more expensive poles, especially at lengths less than 16m. The 2eX-S 50#1 will meet the majority of “serious” anglers needs and was a favourite with the test team for the confidence it gave when handling big fish. Built alongside and to the same high quality standards as our top-end Xitan poles. Visibly reinforced at all section stress points, with overwrapped joint areas to resist wear, guaranteeing both strength and long life. 2eX-S poles are “ready to fish” with pre-bushed topkits, so no cutting back and lost length - just add elastic and go fishing! Elastic rating 16. Supplied with our revolutionary Square Pole Protector section for easy and comfortable fishing at long lengths - no more “elbow pain” !



Code	Model	Length	Sections	Tr.-Length	Weight
10205 134	Pole + Pole Protector	13,00 m	8	1,75 m	920 g
10205 135	Set 13 m Cont.	13,00 m	8	1,75 m	920 g
10205 147	Set 14,5 m	14,50 m	9	1,75 m	1220 g
10205 999	Extension 14,5/16 m	1,75 m	1	1,75 m	300 g
10205 996	Kit 4/1 3,9 mm	5,90 m	4	1,60 m	170 g

### +++SET KIT CONFIGURATION+++

Code	Model	Kit 4/1	Top Kits	Cup. Kit	Uni-C	Pole Prot.
10205 135	Set 13 m	1	-	1	-	2
10205 147	Set 14,5 m	-	4	1	1	1

## 2eX-S 40#1

The perfect “allrounder” for anglers who mainly fish at 13m or less, but still easy to use at 14.5m, especially with our amazing square protector section fitted! The 2eX-S 40#1 provides levels of performance and quality never offered before at this price level. It has most of the same advanced features found on our most expensive poles – this really is a “top-end” pole at a “mid-range” price. Built alongside and to the same high quality standards as our top-end Xitan poles. Visibly reinforced at all section stress points and with thickened joints to resist wear, guaranteeing both strength and long life. 2eX-S poles are “ready to fish” with pre-bushed topkits, so no cutting back and lost length - just add elastic and go fishing! Elastic rating 16+. Supplied with our revolutionary Square Pole Protector section for easy and comfortable fishing at long lengths - no more “elbow pain” !

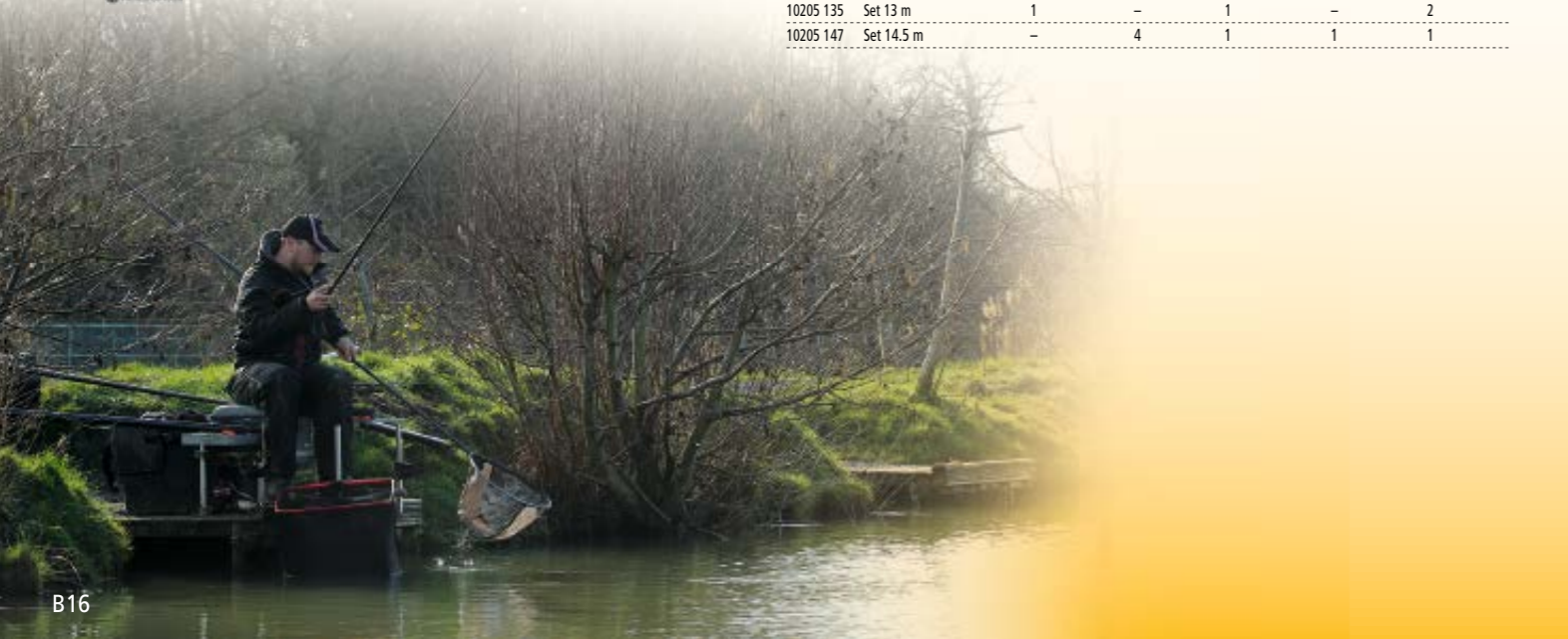



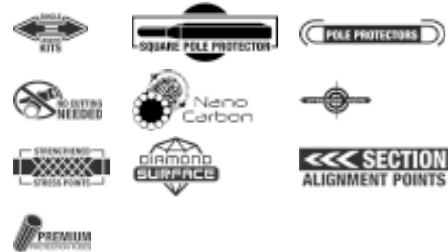

Code	Model	Length	Sections	Tr.-Length	Weight
10206 134	Pole + Pole Protector	13,00 m	8	1,75 m	970 g
10206 135	Set 13 m Cont.	13,00 m	8	1,75 m	970 g
10206 136	Set 13 m	13,00 m	8	1,75 m	970 g
10206 999	Extension 14,5/16 m	1,75 m	1	1,75 m	300 g

+++SET KIT CONFIGURATION+++

Code	Model	Kit 4/1	Top Kits	Cup. Kit	Uni-C	Pole Prot.
10206 135	Set 13 m Cont.	1	-	1	-	2
10206 136	Set 13 m	-	3	1	1	1

### 2eX-S 30#1

An excellent value, very strong and reliable pole with many of the same advanced features found on the most expensive Browning poles. Will comfortably handle any type of pole fishing, for any type of fish – big or small. The 2eX-S 30#1 is a tough pole that will withstand hard use, with the added benefit of low-cost spares and accessories that will keep long term ownership cheap. Built alongside and to the same high quality standards as our top-end Xitan poles. Visibly reinforced at all section stress points and with thickened joints to resist wear, guaranteeing both strength and long life. 2eX-S poles are “ready to fish” with pre-bushed topkits, so no cutting back and lost length - just add elastic and go fishing! Elastic rating 16+. Supplied with our revolutionary Square Pole Protector section for easy and comfortable fishing at long lengths - no more “elbow pain” !



Code	Model	Length	Sections	Tr.-Length	Weight
10403 133	Pole	13,00 m	8	1,75 m	966 g
10403 134	Set 13 m	13,00 m	8	1,75 m	966 g
10403 999	Extension 14,5/16 m	1,75 m	1	1,75 m	345 g
10403 996	Kit 4/1 5,5 mm	5,90 m	4	1,60 m	185 g

+++SET KIT CONFIGURATION+++

Code	Model	Kits 2/1	Cup. Kit	Pole Prot.
10403 134	Set 13 m	4	1	1

### 2eX-S Ultra Carp#1

This is the specialist carp pole of Browning's hugely successful 2eX-S range and has been designed for the angler who wants an extra level of strength and durability from their pole. This is a very strong pole that will easily handle large carp and heavy tackle. The Ultracarp uses the same quality carbon as other 2eX-S poles, but the important middle sections have been externally reinforced with an X weave carbon tape. In addition, the most common breakage areas near the section ends have been overwrapped to resist the cracking and breakages caused by gripping the pole too tightly, or contact damage from seatbox legs, rollers etc. Despite its supreme strength, the Ultracarp is lighter and stiffer than typical power poles in this price range. The pole is supplied with pre-bushed, large bore topkits, ready to take the largest elastics without any need for cutting. Elastic rating 20+. Supplied with one of our revolutionary Square Pole Protectors for easy and comfortable fishing – no more elbow pain!



Code	Model	Length	Sections	Tr.-Length	Weight
10601 800	Set 8 m	8,00 m	5	1,75 m	352 g
10601 989	2eX-S Pole Protector fits 4/5	0,90 m	1	0,90 m	268 g

+++SET KIT CONFIGURATION+++

Code	Model	Kits 2/1	Pole Prot.
10601 800	Set 8 m	1	1

### 2eX-S Margin#1

The 2eX-S margin pole is 8 metres of pure power and will allow you to fish for those huge margin fish with total confidence that whatever takes your bait your 2eX-Se will not let you down! Like the longer 2eX-S Ultracarp, this is a very strong pole that will easily handle the heaviest tackle. The middle sections are externally reinforced with an X weave carbon tape. In addition, the most common breakage areas near the section ends have been overwrapped to resist the cracking and breakages caused by gripping the pole too tightly, or contact damage from seatbox legs, rollers etc. The pole is fully section compatible with all poles in the Browning 2eX-S and Xitan ranges. Incl. 1x 2/1 Kit 5,5mm. Elastic rating 20+.

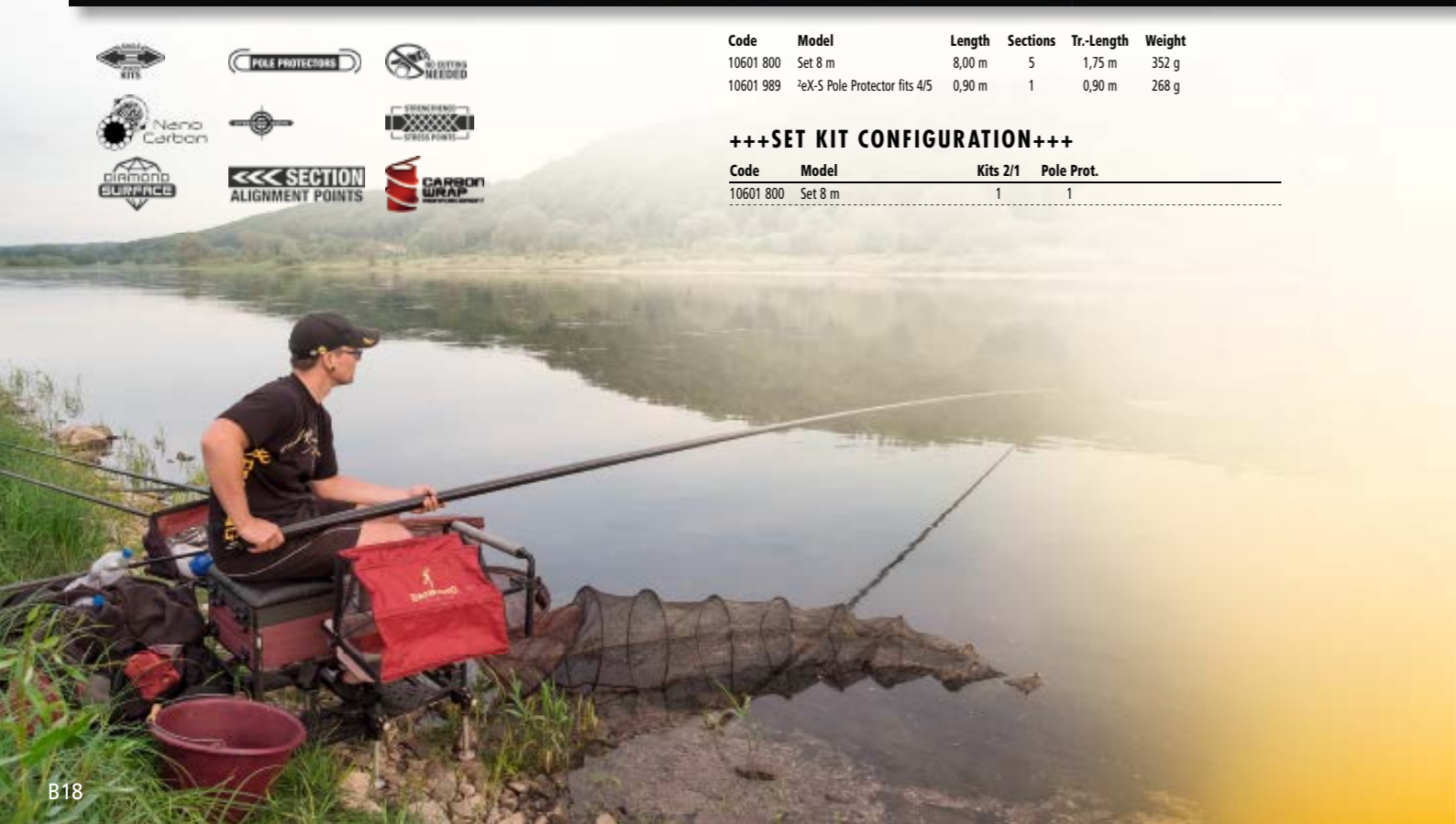



## HYPER CARP COMPETITION 13

### HCC 90

20+



Code	Model	Length	Sections	Tr.-Length	Weight
10407 115	Pole	11,50 m	7	1,85 m	671 g
10407 117	Set 11,5 m	11,50 m	7	1,85 m	671 g
10407 130	Pole	13,00 m	8	1,85 m	972 g
10407 132	Set 13 m	13,00 m	8	1,85 m	972 g
10407 999	Extension 14,5/16 m	1,85 m	1	1,85 m	286 g
10407 904	Topkit Adapter Section	1,50 m	1	1,52 m	68 g
10407 996	Kit 3/1	4,05 m	3	1,52 m	109 g
10407 991	Uni Cupping Kit 2/1	2,60 m	2	1,45 m	30 g
10407 994	Kit 2/1	2,60 m	2	1,45 m	49 g
10407 995	Uni Pulla Kit 2/1, 4,5 mm	2,60 m	2	1,45 m	56 g

#### +++SET KIT CONFIGURATION+++

Code	Model	Kit 2/1	Kit 3/1	Cup. Kit
10407 117	Set 11.5 m	2	-	1
10407 132	Set 13 m	-	4	1

## Hyper Carp Competition HCC 90

Hypercarp Competition HCC 90 - The ultimate carp competition pole

The new Hypercarp Competition range of poles are specifically designed for anglers who competition fish for large carp with very strong tackle, including French "Carpdrome" styles. The strength of these poles also makes them perfect for catching strong fish like barble from big rivers. The HCC 90 is at the top of the range and is specially designed for the carp match angler who wants the best. The pole is much stiffer and responsive than typical power poles of this type. This rigidity provides a very direct contact with the float, and therefore less missed fish! Perfectly balanced at all lengths, the HCC90 is a top quality competition pole that performs and feels like a "normal" match pole – but with incredible reserves of strength.

#### HCC 90 Key features

- The first choice for the serious competition anglers targeting larger carp or other hard fighting fish
- A true 13m (and 16m) pole "ready to fish" – no cutting back or adjustment needed Highest quality carbon with special internal reinforcing which adds strength but minimal extra weight
- External carbon cross-wrap on all female joints to strengthen the section walls and resist joint damage
- Supplied with large bore, pre-bushed, Single Length Kits which accept the heaviest elastics.
- Topkits pre-fitted with a new large sized Browning angled pulla bush to accept 4mm+ elastics
- HCC poles are topkit compatible with all Browning Xitan poles, and some other older model poles
- Elastic rating 20+.

## HYPER CARP COMPETITION 11.5

### HCC 70

20+



Code	Model	Length	Sections	Tr.-Length	Weight
10408 115	Pole	11,50 m	7	1,85 m	727 g
10408 117	Set 11,5 m	11,50 m	7	1,85 m	727 g
10408 130	Pole	13,00 m	8	1,85 m	1026 g
10408 132	Set 13 m	13,00 m	8	1,85 m	1026 g
10408 999	Extension 14,5/16 m	1,85 m	1	1,85 m	307 g
10408 996	Kit 3/1	4,05 m	3	1,52 m	109 g

#### +++SET KIT CONFIGURATION+++

Code	Model	Kit 2/1	Kit 3/1	Cup. Kit
10408 117	Set 11.5 m	1	-	1
10408 132	Set 13 m	-	3	1

## Hyper Carp Competition HCC 70

Hypercarp Competition HCC 70 – Top performance and quality from a carp match pole

The new Hypercarp Competition range of poles are specifically designed for anglers who competition fish for large carp with very strong tackle, including French "Carpdrome" styles. The strength of these poles also makes them perfect for catching strong fish like barble from big rivers. The HCC 70 offers the same build quality and advanced features found on the range topping HCC90 pole, but at a lower price to suit more budgets. The 70 uses slightly different grades of carbon, but careful design means that it still delivers very impressive response and balance for a power pole of this type, especially at the popular 11.5m length. The revised carbon grades also means the HCC70 is slightly stronger than the 90 model, so it is also good choice for anglers who prioritise power and strength over the pole's weight.

#### HCC70 Key features

- A perfect choice for competition angler targeting larger carp or other hard fighting fish
- A true 11.5 or 13m pole "ready to fish" – no cutting back or adjustment needed
- Extensions available to 14.5 and 16m
- Top quality carbon with special internal reinforcing which adds strength but minimal extra weight
- External carbon cross-wrap on all female joints to strengthen the section walls and resist joint damage
- Supplied with large bore, pre-bushed, Single Length Kits which accept the heaviest elastics.
- Topkits pre-fitted with a new large sized Browning angled pulla bush to accept 4mm+ elastics
- HCC poles are topkit compatible with all Browning Xitan poles, and some other older model poles
- Elastic rating 20+.







Code	Model	Length	Sections	Tr.-Length	Weight
1958 130	Pole	13,00 m	8	1,85 m	1145 g
1958 133	Set 13 m	13,00 m	8	1,85 m	1145 g
1958 999	Extension 14,5 m	1,85 m	1	1,85 m	310 g
1958 998	Mini Extension	0,75 m	1	0,75 m	216 g
1958 991	Uni Cupping Kit	2,45 m	2	1,45 m	48 g
1958 994	Puller Kit	2,45 m	2	1,45 m	50 g
1958 996	4/1 Kit	5,30 m	4	1,75 m	214 g
W195 823	Pulla C Section HC-60-130	1,50 m	1	1,50 m	69 g

### +++SET KIT CONFIGURATION+++

Code	Model	Length	Puller Kit	Cupping Kit	Mini Extension
1958 133	Set 13 m	13,00 m	2	1	1

## Hyper Carp HC 60-130

Hypercarp HC60-130 - Hypercarp poles are extreme poles for extreme situations! All poles in the Hypercarp range are specialist poles specifically designed for catching the largest carp on the strongest tackle. These pole take over where normal "power poles" are found to be too weak. They are constructed using high quality carbon – essential to keep the pole stiff – however the section walls and joint areas have been significantly thickened and strengthened to eliminate weakspots. The Hypercarps are slightly heavier than conventional poles, but are well balanced to easily useable at full length. Whatever size of fish – a Hypercarp will not let you down! The HC60-130 is top of the Hypercarp range and is remarkably light and stiff for a pole with so much power and strength. Perfect balance means that the pole retains its responsiveness and rigidity all the way to 13m and beyond. This is a high performance, top quality pole for specialist fishing – do not confuse with the typical crude and "soft" strong poles.

### HC60-130 Key features

- A pole specifically designed to catch the largest carp on the strongest tackle
- The pole "ready to fish" with no cutting back needed, extensions available to 14.5m
- Built using high quality carbon to keep the pole stiff and responsive without sacrificing strength
- Increased wall strength and joint thickness on all sections to eliminate potential stress points
- Supplied with large bore, pre-bushed, Single Length Kits which accept the heaviest elastics.
- Adapter section available which allows Browning Xitan and HCC topkits to be used
- Elastic rating unlimited .... Fish size unlimited!



Code	Model	Length	Sections	Tr.-Length	Weight
1959 115	Pole	11,50 m	7	1,85 m	990 g
1959 118	Set 11,5 m	11,50 m	7	1,85 m	990 g
1959 994	2/1 Multi Purpose Kit	2,45 m	2	1,45 m	49 g
1959 995	Puller Kit	2,45 m	2	1,45 m	52 g
1959 996	4/1 Kit	5,30 m	4	1,75 m	230 g
1959 998	Mini Extension	0,90 m	1	0,95 m	248 g
W195 923	Pulla C Section HC-40-115	1,50 m	1	1,50 m	71 g

### +++SET KIT CONFIGURATION+++

Code	Model	Length	Puller Kit	Cupping Kit	Mini Extension
1959 118	Set 11,5 m	11,50 m	1	1	1

## Hyper Carp HC 40-115

Hypercarp HC40-115 - Hypercarp poles are extreme poles for extreme situations! All poles in the Hypercarp range are specialist poles specifically designed for catching the largest carp on the strongest tackle. These pole take over where normal "power poles" are found to be too weak. They are constructed using high quality carbon – essential to keep the pole stiff – however the section walls and joint areas have been significantly thickened and strengthened to eliminate weakspots. The Hypercarps are slightly heavier than conventional poles, but are well balanced to easily useable at full length. Whatever size of fish – a Hypercarp will not let you down! The HC40-115 is the mid point of the Hypercarp range. By carefully balancing the section weights we have been able to keep the HC40 acceptably light and stiff for a pole with so much power and strength. Easily fishable at full length, but absolutely devastating when used shorter for "hit and hold" fishing.

### HC40-115 Key features

- A pole specifically designed to catch the largest carp on the strongest tackle
- The pole "ready to fish" with no cutting back needed, extensions available to 13m
- Built using high quality carbon to keep the pole stiff and responsive without sacrificing strength
- Increased wall strength and joint thickness on all sections to eliminate potential stress points
- Supplied with large bore, pre-bushed, Single Length Kits which accept the heaviest elastics.
- Adapter section available which allows Browning Xitan and HCC topkits to be used
- Elastic rating unlimited .... Fish size unlimited!







Code	Model	Length	Sections	Tr.-Length	Weight
10404 950	Pole	9,50 m	6	1,85 m	811 g
10404 952	Set 9,5 m	9,50 m	6	1,85 m	811 g
10404 999	Extension 11 m	1,85 m	1	1,85 m	276 g
10404 996	Kit 3/1	3,90 m	3	1,53 m	118 g

+++SET KIT CONFIGURATION+++

Code	Model	Kit 3/1	Cup. Kit
10404 952	Set 9,5 m	1	1

### Hyper Carp HC 20

Hypercarp HC20-950 - Hypercarp poles are extreme poles for extreme situations! All poles in the Hypercarp range are specialist poles specifically designed for catching the largest carp on the strongest tackle. These pole take over where normal "power poles" are found to be too weak. They are constructed using high quality carbon – essential to keep the pole stiff – however the section walls and joint areas have been significantly thickened and strengthened to eliminate weakspots. The Hypercarps are slightly heavier than conventional poles, but are well balanced to easily useable at full length. Whatever size of fish – a Hypercarp will not let you down!

The HC20-950 is the entry point of the Hypercarp range and is perfect for anglers who do not need a longer pole. Has all the same features found on the more expensive HC40 and 60 models and is absolutely devastating when used for short range "hit and hold" when fishing close to snags.

- HC20-950 Key features
- A pole specifically designed to catch the largest carp on the strongest tackle
  - The pole "ready to fish" with no cutting back needed, extensions available to 13m
  - Increased wall strength and joint thickness on all sections to eliminate potential stress points
  - Supplied with large bore, pre-bushed, Single Length Kits which accept the heaviest elastics.
  - Adapter section available which allows Browning Xitan and HCC topkits to be used
  - Elastic rating unlimited .... Fish size unlimited!



Code	Model	Length	Sections	Tr.-Length	Weight
10405 600	Pole	6,00 m	4	1,80 m	285 g

### Hyper Carp Brutale

Hypercarp Brutale 6m Margin Pole – "Take no prisoners !!!" As its name suggests, the Brutale is the strongest margin pole available and is capable of taming the largest carp, on the strongest tackle, in any conditions or from any swim. Fish for those huge margin fish with total confidence that whatever takes your bait the Brutale will not let you down.

- HC Brutale 6m Key features
- Ultra strong and "ready to fish" with no cutting back needed
  - Fully section compatible with the longer Hypercarp poles so a useful second pole
  - Supplied with large bore, pre-bushed, Single Length Kits which accept the heaviest elastics.
  - Elastic rating unlimited .... Fish size unlimited!







Sphere and Silverlite poles use a shared mandrel so all parts and accessories listed can be used on both ranges. Xitan topkits can also be used on these poles. All parts are made to the same high quality as the poles they were designed for.

## Sphere/Silverlite Pole Protectors

Our unique Square protector sections to fit the 13m and 14.5/16m sections, as supplied with the Sphere pole, plus a round reversible version for 9/11m.

Code	Model	Length	Weight	Sections	Tr.-Length
10211 985	Ergonomic Pole Protector II	1,00 m	230 g	1	1,00 m
10211 986	Ergonomic Pole Protector III	1,00 m	230 g	1	1,00 m
10211 987	Pole Protector 6/7	1,00 m	155 g	1	1,00 m



## Sphere/Silverlite C-Sections

Short and full length universal C sections for all poles in range.

Code	Model	Length	Weight	Sections	Tr.-Length
10211 905	Sphere/Silverlite Short C	1,00 m	36 g	1	1,00 m
10210 904	Sphere/Silverlite Uni C Section	1,51 m	48 g	1	1,51 m



## Sphere/Silverlite Extender & Adjusta Sections

1m extension to take poles to 17m, plus Adjusta sections that can be cut to make pole an exact length.

Code	Model	Length	Weight	Sections	Tr.-Length
10211 989	17 m Extender Section 1 m	1,00 m	225 g	1	1,00 m
10210 989	Adjusta Section I 10-06 13 m	1,00 m	163 g	1	1,00 m
10201 988	Adjusta Section II fits 14.5/16 m	1,00 m	170 g	1	1,00 m
10201 989	Adjusta Section I 10-12 13 m	1,00 m	157 g	1	1,00 m



## Xitan Pole Protectors

Purpose designed short butt sections. Pole Protectors are reversible and fit every middle section. Built-in skid bungs protect sections from chipping and cracking. Also give useful pole length options. These Pole Protectors are fully compatible with previous Xitan poles like the Z9.

Code	Model	Length	Weight	Sections	Tr.-Length
1883 988	Xitan Pole Protector 5/6	0,75 m	113 g	1	0,75 m
10205 989	Xitan Pole Protector 6/7	0,80 m	275 g	1	0,80 m
10601 989	²eX-S Pole Protector fits 4/5	0,90 m	268 g	1	0,90 m



Xitan and ²eX-S poles use a shared mandrel so most parts and accessories listed can be used on both ranges. Silverlite and Sphere topkits can also be used on these poles. All parts are made to the same high quality as the poles they were designed for.

## Xitan / ²eX-S Square Pole Protectors

Our unique square section Pole Protectors as supplied with Advance & ²eX-Spoles. Fit 11, 13 and 14.5/16m sections. Plus round, reversible sections to fit from the 5th to the 11m section. Help protect poles from end damage and give useful length options.

Code	Model	Length	Weight	Sections	Tr.-Length
1896 987	Xitan Advance Square Pole Protector I	0,85 m	216 g	1	0,85 m
1896 988	Xitan Advance Square Pole Protector II	0,85 m	220 g	1	0,85 m
1896 989	Xitan Advance Square Pole Protector III	0,85 m	225 g	1	0,85 m
10203 989	²eX-S Square Pole Protector II	0,85 m	215 g	1	0,85 m



## Xitan Advance Topkits

Top quality kits as supplied with our Advance pole range. Puller bush and stud versions (with drilling bands). Special PTFE internal bush allows tip size to be chosen.

Code	Model	Length	Weight	Sections	Tr.-Length
10801 982	SLKa Match Kit 2/1 3,0 mm	2,60 m	40 g	2	1,40 m
10801 983	SLKa Duo Kit 2/1 3.9/4.5mm	2,60 m	40 g	2	1,40 m
10801 993	SLKa Duo Pulla Kit 2/1 3.9/4.5mm	2,60 m	46 g	2	1,40 m
10801 994	SLKa Pulla Kit 2/1 5.5mm	2,60 m	46 g	2	1,40 m
1896 991	SLKs 1 Piece Kit 4.5mm	1,90 m	40 g	1	1,90 m



## Xitan/²eX-S Power Topkits

Extra strength pre-bushed kits supplied with out ²eX-S pole range and Xitan Margin pole. Available in 2 lengths with 3 tip diameters. All have drilling bands.

Code	Model	Length	Weight	Sections	Tr.-Length
10205 994	SLKe-P Kit 2/1, 3,9mm	2,60 m	55 g	2	1,45 m
10205 995	SLKe-P Kit 2/1, 4,5 mm	2,60 m	55 g	2	1,45 m
10205 997	SLKe-P Kit 2/1, 5,5 mm	2,60 m	55 g	2	1,45 m
10203 993	SLKe-L Kit 2/1, 3,0mm	3,00 m	52 g	2	1,60 m
10203 984	SLKe-L Kit 2/1, 3,9mm	3,00 m	52 g	2	1,60 m
10203 985	SLKe-L Kit 2/1, 4,5 mm	3,00 m	52 g	2	1,60 m



## Xitan / ²eX-S Power Sections

Low cost, short and full length, power C sections for all poles. Power C is light so does not unbalance the pole. Useful when some extra strength is required.

Code	Model	Length	Weight	Sections	Tr.-Length
10203 904	Power Uni-C Section	1,50 m	53 g	1	1,50 m
10203 905	Short Uni-SC Section	0,75 m	33 g	1	0,75 m



## Xitan / ²eX-S Cupping Kits

3 lengths to match the topkit options. Pre-fitted with standard screw fitting to suit Browning and some other brand cups.

Code	Model	Length	Weight	Sections	Tr.-Length
10203 991	SLKe-P Cupping Kit 2/1 2,60 m	2,60 m	49 g	2	1,45 m
10203 992	SLKe-L Cupping Kit 2/1 3,0 m	3,00 m	52 g	2	1,60 m
1896 992	SLKs 1 Piece cupping kit	1,90 m	40 g	1	1,90 m



## Browning Topkit Adapter Section

Special short "D" topkit adapter section. Allows topkits from some other leading pole brands to be used on all Browning poles. Takes topkits with an 18mm joint size.

Code	Model	Length	Weight	Sections
10211 904	Topkit Adapter Section D 18 > 22m	22 cm	5,8 g	1



## Xitan Extender & Adjusta sections

1m extension to take Advance poles to 17m, plus a 13m Adjusta section that can be cut to make the pole an exact length.

Code	Model	Length	Weight	Sections	Tr.-Length
10801 987	Xitan 17 m Extender Section 1.00m	1,15 m	200 g	1	1,15 m
1883 987	Xitan 13m Length Adjusta Section	1,10 m	230 g	1	1,10 m





### +++SET KIT CONFIGURATION+++

Code	Model	Length	Kit 3/1	Pole Prot.
10002 112	Set 11,00 m	11,00 m	1	1

## Black Magic® Classic

The return of a true legend amongst poles! Our original Black Magic 1, 2 & 3 put-in poles built an un-rivalled reputation for strength and durability and were the first choice for long line "to-hand" fishing, or for anglers wanting ultimate strength in a pole. Many are still giving excellent service - but are getting a little old! Therefore, and by popular demand, we have re-introduced the famous Black Magic under the "Classic" name for 2016. The new pole is made on the same mandrel as the originals, using the same carbon quality and manufacturing standards.

Code	Model	Length	Sections	Tr-Length	Weight
10002 110	Pole	11,00 m	9	1,52 m	650 g
10002 112	Set 11 m	11,00 m	9	1,52 m	650 g
10002 989	Pole Protector II	0,70 m	1	0,70 m	83 g
10002 999	Extension 12,5 m	1,52 m	1	1,52 m	185 g
10002 994	Kit 3/1	2,24 m	3	0,96 m	26 g



### +++SET KIT CONFIGURATION+++

Code	Model	Kit 4/1	Cupping Kit	Kit 2/1	Pole Prot.
10209 113	Set 11 m	1	1	-	-
10209 114	Set 11,00 m	-	1	2	1
10209 127	Set 12,50 m	-	1	3	1

## Black Magic® II Gold

The new Black Magic Gold is effectively a "short" top-end pole. It has been specifically designed for anglers who want a top quality, very light, slim and stiff pole - but do not want or need a very "long" pole for their fishing. The Gold is made of top quality carbon and built alongside, and to the same quality standards, as our most expensive Xitan poles. The pole is "ready-to-fish" with pre-bushed topkits (no cutting back needed) and is supplied with one of our short Pole Protector mini sections, plus a full sized holdall.

Code	Model	Length	Sections	Tr-Length	Weight
10209 110	Pole	11,00 m	7	1,75 m	760 g
10209 113	Set 11 m Cont.	11,00 m	7	1,75 m	760 g
10209 114	Set 11 m	11,00 m	7	1,75 m	760 g
10209 127	Set 12,5 m	12,50 m	8	1,75 m	1015 g
10209 999	Extension 11/12,5 m	1,75 m	1	1,75 m	315 g
10209 989	Pole Protector	0,85 m	1	0,85 m	158 g
10209 994	Uni Kit 2/1	2,60 m	2	1,50 m	60 g
10209 995	Cupping Kit 2/1	2,60 m	2	1,50 m	60 g
10209 996	Kit 4/1 4,5 mm	5,50 m	4	1,49 m	178 g







### +++SET KIT CONFIGURATION+++

Code	Model	Length	Kit 2/1
10401 113	Set 11,00 m	11,00 m	1



### +++SET KIT CONFIGURATION+++

Code	Model	Length	Kit 2/1
10600 802	Set 8,00 m	8,00 m	2



### +++SET KIT CONFIGURATION+++

Code	Model	Kit 2/1
10400 102	Set 10 m	2

## Black Magic® Carp

A power pole built in the Black Magic tradition of strong and tough poles that will take everything asked of them! Slim, stiff and excellent value, the Black Magic Carp will give years of reliable service. Big carp, big tench, big barbel ... no problem! Rated for elastics to 20+.

Code	Model	Length	Sections	Tr.-Length	Weight
10401 110	Pole	11,00 m	7	1,82 m	958 g
10401 113	Set 11 m	11,00 m	7	1,82 m	958 g
10401 994	Power Kit 2/1	3,00 m	2	1,59 m	70 g
10401 996	Kit 4/1	6,00 m	4	1,61 m	240 g

## Black Magic® Margin

A very strong margin pole built in the Black Magic tradition. Very stiff and remarkably light in weight considering its power and strength. Strong enough for any size of pole elastic and any size of fish. Has a very large diameter tip so does not need any cutting back for even the largest elastics so no lost pole length. Pure Black Magic !

Code	Model	Length	Sections	Tr.-Length	Weight
10600 800	Pole	8,00 m	6	1,55 m	790 g
10600 802	Set 8 m	8,00 / 1,55 m	6		790 g
10600 993	Kit 2/1	2,40 m	2	1,30 m	72 g

## Battle Carp 1000

Ultra strong and excellent value pole that is perfect for "battling" carp, but can also be used for all types of fishing.

Code	Model	Length	Sections	Tr.-Length	Weight
10400 100	Pole	10,00 m	6	1,80 m	919 g
10400 102	Set 10 m	10,00 m	6	1,80 m	919 g
10400 992	2/1 Kit	2,90 m	2	1,51 m	86 g







SECTION ALIGNMENT POINTS



NO CUTTING NEEDED SECTION ALIGNMENT POINTS



Supplied with elastic fitted so are "ready to use".

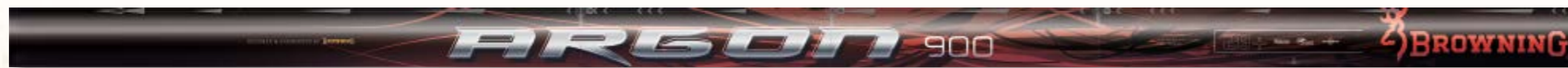

## Aggressor Pro Canal

The Aggressor Pro Canal is a fantastic addition to our range of entry-level, carbon-fibre poles.

Code	Model	Length	Sections	Tr.-Length	Weight
10207 110	Pole	11,00 m	8	1,70 m	954 g
10207 950	Pole	9,50 m	7	1,70 m	624 g
10207 993	Kit 3/1	1,90 m	2	1,50 m	75 g

## Aggressor Carp II

A new and improved version of Browning's Aggressor Carp pole. A strong and reliable pole that can be used for any size of fish. The carbon grade used as been selected to give the best balance of weight and pole strength.

Code	Model	Length	Sections	Tr.-Length	Weight
10406 950	Pole	9,50 m	8	1,60 m	870 g
10406 993	Kit 3/1	2,90 m	3	1,22 m	50 g
10406 999	Extension 11 m	1,60 m	1	1,60 m	355 g

## Pit Bull

"Ready to go" strong poles – just attach a pole rig and you're ready to fish! Available at 4 & 6 meters, both poles are strong but not too heavy. The 4m Pit Bull is fitted with elastic suitable for 4 to 8lb line and hard-fighting fish like carp and tench. The 6m version includes an extra top-kit with lighter elastic, suitable for smaller fish like perch and bream. Both poles come in a rigid protective carry tube.

Code	Model	Length	Sections	Tr.-Length	Weight
1871 400	Pole + 2/1 Kit	4,00 m	4	1,17 m	240 g
1871 600	Pole + 2/1 Kit	6,00 m	6	1,17 m	550 g
1871 994	Top 2 Kit not elasticated	2,00 m	2	1,00 m	64 g

## Argon

A new range of shorter poles that are suitable for all styles of fishing. Slim, very strong and easy to use, the Argon poles are perfect for anglers who do not want or need a longer pole. All have hollow tips so fitting elastics is easy and quick, with no cutting needed. A reliable pole for all purposes.

Code	Model	Length	Sections	Tr.-Length	Weight
10001 600	Argon	6,00 m	5	1,67 m	425 g
10001 750	Argon	7,50 m	6	1,72 m	664 g
10001 900	Argon	9,00 m	7	1,72 m	930 g







## Margin Mauler II

Our totally unique "hit 'n hold" margin pole that has gained the reputation as being the strongest margin pole on the market. Any size of fish and any size of elastic – the Mauler will handle it! The Mauler has a parallel middle section which can be added or removed to allow the handle section, which has slip-proof EVA grips, to be used at 2 different lengths. The tip section has a big diameter and needs no cutting back for the strongest elastics on the market.

Code	Model	Length	Sections	Tr.-Length	Weight
10605 500	Pole	5,00 m	4	1,34 m	395 g
10605 993	Puller Kit 2/1	2,45 m	2	1,34 m	85 g

## Aggressor Margin

Margin pole with noticeably strengthened sections. With a drilling band on the B-section for using Pulla Bushes. The blank is particularly sturdy and pressure-resistant in the lower B and C sections, allowing you to handle even big carp safely.

Code	Model	Length	Sections	Tr.-Length	Weight
10604 700	Pole	7,00 m	6	1,45 m	578 g
10604 993	Kit 2/1	2,20 m	2	1,15 m	49 g

## Exciter

An "Exciting" multi-purpose pole suitable for any type of pole fishing. Strong, good looking, reliable and excellent value for money. A perfect starter pole or for those on a limited budget.

Code	Model	Length	Sections	Tr.-Length	Weight
1497 650	Pole	6,50 m	5	1,55 m	590 g
1497 800	Pole	8,00 m	6	1,55 m	870 g
1497 993	Kit 2/1	2,15 m	2	1,40 m	24 g

## Black Magic® SLF Tele

A perfect rod series for fishing to hand. The Black Magic SLF sits lightly in the hand and has an ultra-rapid action. The rod allows even larger fish to be tamed with ease during a fight. The lengths of 5, 6, 7, 8 and 9 m cover all requirements in long-range fishing.

Code	Model	Length	Sections	Tr.-Length	Weight
10007 100	Black Magic® SLF Tele	10,00 m	9	1,40 m	530 g
10007 500	Black Magic® SLF Tele	5,00 m	5	1,40 m	150 g
10007 600	Black Magic® SLF Tele	6,00 m	6	1,40 m	200 g
10007 700	Black Magic® SLF Tele	7,00 m	7	1,40 m	260 g
10007 800	Black Magic® SLF Tele	8,00 m	7	1,40 m	330 g
10007 900	Black Magic® SLF Tele	9,00 m	8	1,40 m	420 g





### Argon Tele

Incredible telescopic pole at an amazing low price. An ace up your sleeve when it comes to catching small fish quickly near the bank.

Code	Model	Length	Sections	Tr.-Length	Weight
10006 500	500 F	5,00 m	5	1,14 m	212 g
10006 600	600 F	6,00 m	6	1,14 m	298 g
10006 700	700 F	7,00 m	7	1,14 m	379 g



### Exciter Tele

The value alternative for the occasional pole angler. With a higher fibreglass content in the rear sections the model is a price-crusher and, thanks to the combination of materials, can withstand the occasional mishandling by the inexperienced angler.

Code	Model	Length	Sections	Tr.-Length	Weight
10000 500	Exciter Tele	5,00 m	5	1,15 m	341 g
10000 600	Exciter Tele	6,00 m	6	1,15 m	494 g



### Exciter Power Tele

Strong and durable telescopic carbon rods in a range of the most popular lengths. The Exciter Power Tele has an action and power enough to comfortably land even large and hard-fighting fish.

Code	Model	Length	Sections	Tr.-Length	Weight
10003 500	Exciter Power Tele	5,00 m	5	1,14 m	295 g
10003 600	Exciter Power Tele	6,00 m	6	1,14 m	395 g
10003 700	Exciter Power Tele	7,00 m	7	1,14 m	519 g



Ideal starter pole as virtually unbreakable in normal use.

### Basalt Ultra Tele

An ultra-strong range of telescopic poles made of a new composite material that provides incredible rigidity compared to traditional materials.

Code	Model	Length	Sections	Tr.-Length	Weight
1884 400	Basalt Ultra Tele	4,00 m	4	1,15 m	185 g
1884 500	Basalt Ultra Tele	5,00 m	5	1,15 m	330 g
1884 600	Basalt Ultra Tele	6,00 m	6	1,15 m	480 g
1884 700	Basalt Ultra Tele	7,00 m	7	1,15 m	660 g
1884 800	Basalt Ultra Tele	8,00 m	8	1,15 m	880 g







## Silverlite Bolo 10-14

When you make first-class poles like Browning you should also be able to prove your expertise in terms of Bolo rods. The Silverlight Bolo 10-14 is the flagship: Super-light, fast and stiff, and with a high quality finish throughout – from the reel holder to the whipping and the slide rings of the top two sections which sit on carbon sleeves.

Code	Model	Length	Sections	C.W.	Tr-Length	Weight
1998 600	Silverlite Bolo 10-14	6,00 m	6	30 g	1,40 m	268 g
1998 700	Silverlite Bolo 10-14	7,00 m	7	30 g	1,40 m	362 g
1998 800	Silverlite Bolo 10-14	8,00 m	8	30 g	1,40 m	485 g

## Silverlite Bolo 10-08

The affordable sibling of the Silverlight Bolo 10-14: the 10-08 version is a Bolognese rod that has a somewhat more powerful action yet is still incredibly light to hold. Equipped with SIC rings and finished in the latest high modulus carbon fibre. All ring joints are sealed with epoxy resin.

Code	Model	Length	Sections	C.W.	Tr-Length	Weight
1979 600	Silverlite Bolo 10-08	6,00 m	6	30 g	1,45 m	272 g
1979 700	Silverlite Bolo 10-08	7,00 m	7	30 g	1,45 m	387 g
1979 800	Silverlite Bolo 10-08	8,00 m	8	30 g	1,45 m	513 g

## Black Magic® SLF Bolo

This rod combines the benefits of an ultra-rapid and light bolo rod with substantial power for fighting. Can be used both in rapid currents with heavy float weights and on canals, where striking quickly is of the essence.

Code	Model	Length	Sections	C.W.	Tr-Length	Weight
12700 500	Black Magic® SLF Bolo	5,00 m	5	25 g	1,30 m	240 g
12700 600	Black Magic® SLF Bolo	6,00 m	6	25 g	1,30 m	310 g
12700 700	Black Magic® SLF Bolo	7,00 m	7	25 g	1,30 m	470 g
12700 800	Black Magic® SLF Bolo	8,00 m	7	25 g	1,40 m	530 g





The SPHERE rods are truly from a different world. The rods have been developed using the highest quality carbon available and every other aspect of their design has been engineered to produce a product that is as "perfect" as we can possibly make it.

All SPHERE rods feature:-

- The slimmest, lightest, high-modulus carbon blanks available
  - A unique ergonomic and weight reducing handle which transmits more "feel" to the angler.
- SPHERE rods look and feel like no other rod on the market. We believe that these are the most advanced match style fishing rods available.



## Sphere Spliced-Tip River

Specialist match float rods from the Sphere range developed specifically for river fishing. Both rods feature a 50cm solid carbon tip carefully spliced into the top section. This creates the ultra-fast and stiff action needed to pick up line and connect with bites in flowing water, but with the soft and forgiving tip needed for fine lines and small hooks. These are the ultimate in river rods and the 15'6" / 4.72m version performs much better than traditional "Bolognese" type rods. Like all Sphere rods, we use the highest quality carbon blank and fittings available. Every aspect of the rod has been carefully engineered to be as perfect as possible. Ultra light, ultra slim and fitted with a unique ergonomic weight reducing handle which transmits "feel" to the angler.

Code	Model	Length	Sections	C.W.	Tr.-Length	Weight
12005 410	Sphere Spliced-Tip River	4,11 m / 13,6"	3	30 g	1,41 m	150 g
12005 470	Sphere Spliced-Tip River	4,72 m / 15,6"	3	30 g	1,61 m	175 g

## Sphere Match

The Sphere Match rods, like all rods in the Sphere range, have been developed using the highest quality carbon blank and fittings available. Every aspect of the rods has been carefully engineered to produce a product that is as perfect as possible. The rods are ultra light, ultra slim and are fitted with a unique ergonomic weight reducing handle which transmits more "feel" to the angler. They feature special ultra low friction SIC guides – the best and lightest available. The rods have classic medium-through actions, however the carbon quality and blank design allows these rod to be used for a wide range of float fishing styles - from casting big wagglers on lakes, to fishing small floats at close range. These are the ultimate all-round match rods, and are truly from a "different world"!

Code	Model	Length	Sections	C.W.	Tr.-Length	Weight
1499 390	Sphere Match	3,90 m / 13'	3	30 g	1,37 m	149 g
1499 420	Sphere Match	4,20 m / 14'	3	30 g	1,48 m	157 g





### Sphere Pellet Waggler

By popular request, we have extended the Sphere float rod range to include an 11'3.3m, 2 piece Pellet Waggler rod. This rod is ultra slim and unbelievably light - weighing in at less than 5oz/150gr - which makes the constant casting that is usually need for this technique much less tiring and easier to sustain. The blank has the classic Pellet Waggler parabolic action, but is fast to pick up line due to the inherent stiffness of the ultra high modulus carbon used in its construction. The rod was carefully tested to ensure it has the perfect power for match sized carp. As with all Browning Sphere rods, the Pellet Waggler is finished to the highest standards and features the unique Sphere ergonomic handle.

Code	Model	Length	Sections	C.W.	Tr.-Length	Line Class	Weight
12002 330	Sphere Pellet Waggler	3,30 m / 11'	2	25 g	1,68 m	3 - 6+ lbs	134,18 g

### Sphere Hot Rod Silver Edition

A specialist rod carefully designed for catching small silverfish on light tackle, light lines and small hooks. The rod is extremely light in weight and features a very fine solid carbon tip which has been spliced into the rod main blank. This creates a very fast actioned rod, but with a very soft tip which minimizes hook pulls and lost fish. This rod is so sensitive it can be safely used with lines down to 0.07mm. The rod is a product of the successful Browning Hotrods team who are experts at this type of fishing and have used this type of rod with great effect on drains and small rivers in the east of the UK. The rods has been called "Silver Edition" to commemorate Hotrod's 25 year association with the Browning brand.

Code	Model	Length	Sections	C.W.	Tr.-Length	Line Class	Weight
12000 345	Hot Rod Silver Edition	3,45 m / 11,3"	2	12 oz / 0 - 5 g	1,79 m	-2 lbs	127 g





## Sphere Feeder Quiver Tip

Code	Model	Length	Testcurve
1498 001	Glass fibre	60,00 cm	0,50 oz
1498 002	Glass fibre	60,00 cm	0,75 oz
1498 003	Glass fibre	60,00 cm	1,00 oz
1498 004	Glass fibre	60,00 cm	1,50 oz
1498 005	Carbon	60,00 cm	1,00 oz
1498 006	Carbon	60,00 cm	1,50 oz
1498 007	Carbon	60,00 cm	2,00 oz
1498 008	Carbon	60,00 cm	3,00 oz
1498 009	Carbon	60,00 cm	4,00 oz
1498 010	Carbon	60,00 cm	5,00 oz
1498 011	Carbon	60,00 cm	0,75 oz
1498 012	Carbon	60,00 cm	0,50 oz

## Sphere Braid Special

A specialist feeder rod from the Sphere range developed specifically for fishing with braid or pre-stretched lines. The rod's action has been softened towards the middle and top to eliminate hook-pulls when catching soft mouthed fish like skimmers/bream. However, the lower section retains the "backbone" needed to cast medium sized feeders good distances. The low-friction "skeletal" guides fitted make braid fishing silent and without the normal but irritating "grating" of the braid in the guide on the retrieve. Like all Sphere rods, we use the highest quality carbon blank and fittings available. Every aspect of the rod has been carefully engineered to be as perfect as possible. Ultra light, ultra slim and fitted with a unique ergonomic weight reducing handle which transmits "feel" to the angler. Supplied with 4 carbon tips to suit the action and purpose of the rod.

Code	Model	Length	Sections	C.W.	Tr-Length	Weight
12004 360	Sphere Braid Special	3,60 m / 12'	3	50 g	1,29 m	145 g

Code	Model	provided Feeder Tips
12004 360	Sphere Braid Special	0,5oz, 0,75oz, 1oz, 1,5oz

## Sphere Feeder

The Sphere Feeder rods, like all rods in the Sphere range, have been developed using the highest quality carbon blank and fittings available. Every aspect of the rods has been carefully engineered to produce a product that is as perfect as possible. The rods are ultra light, ultra slim and are fitted with a unique ergonomic weight reducing handle which transmits more "feel" to the angler. They feature special ultra low friction "skeletal" SIC guides – the best and lightest available. The ultimate feeder rods. The superb quality of the SPHERE blanks has allowed us to produce a small range of rods to cover a wide range of feeder fishing situations. The carbon quality of the blank adds meters to a cast and improves casting accuracy by minimising sideways flex when the rod under load. However, the blanks are responsive enough to safely play soft mouthed fish like skimmers without fear of hook-pulls. Supplied with 4 tips to give both sensitivity for bite indication and durability when casting.

Code	Model	Length	Sections	C.W.	Tr-Length	Weight
1498 330	L	3,30 m / 11'	2	70 g	1,74 m	149 g
1498 361	M	3,60 m / 12'	3	80 g	1,29 m	160 g
1498 390	M	3,90 m / 13'	3	80 g	1,38 m	189 g
1498 391	MH	3,90 m / 13'	3	100 g	1,38 m	210 g
1498 420	MH	4,20 m / 14'	3	100 g	1,48 m	258 g
1498 421	H	4,20 m / 14'	3	145 g	1,48 m	278 g

Code	Model	provided Feeder Tips
1498 330	L	0,75 oz, 1 oz, 1,5 oz, 2 oz,
1498 361	M	0,75 oz, 1 oz, 1,5 oz, 2 oz,
1498 390	M	0,75 oz, 1 oz, 1,5 oz, 2 oz,
1498 391	MH	1 oz, 1,5 oz, 2 oz, 3 oz
1498 420	MH	1,5 oz, 2 oz, 3 oz, 4 oz
1498 421	H	2 oz, 3 oz, 4 oz, 5 oz





## Sphere Bomb

The Sphere bomb rod, like all rods in the Sphere range, has been developed using the highest quality carbon blank and fittings available. Every aspect of the rod has been carefully engineered to produce a product that is as perfect as possible. The rod is ultra light, ultra slim and are fitted with a unique ergonomic weight reducing handle which transmits more "feel" to the angler. They feature special ultra low friction "skeletal" SIC guides – the best and lightest available. A soft actioned rod optimised for fishing at ranges to 30m with bomb, or light method and conventional feeders. The top-quality blank is soft enough to be safely used with light lines and small hooks, but has reserves of power in the butt section to tame bigger and hard fighting fish when necessary. Supplied with 4 glass tips to give both sensitivity for bite indication and durability to withstand the demands of carp fishing.

Code	Model	Length	Sections	C.W.	Tr.-Length	Weight
1498 300	Sphere Bomb	3,00 m / 10'	2	25 g / 3 - 6 lbs	1,60 m	133 g
1498 301	+10% Power	3,00 m / 10'	2	35 g / 3 - 6 lbs	1,60 m	133 g

Code	Model	provided Feeder Tips
1498 300	Sphere Bomb	0,50 oz, 0,75 oz, 1 oz, 1,5 oz
1498 301	+10% Power	0,50 oz, 0,75 oz, 1 oz, 1,5 oz



## Champion's Choice Silverlite Pro Quiver Tip

Code	Model	Length	Testcurve
12214 001	Carbon	63,00 cm	0,5 oz
12214 002	Carbon	63,00 cm	0,75 oz
12214 003	Carbon	63,00 cm	1 oz
12214 004	Carbon	63,00 cm	1,5 oz
12214 005	Carbon	63,00 cm	2 oz
12214 006	Carbon	63,00 cm	3 oz

## Champion's Choice Silverlite Feeder Pro

A rod series developed by professionals for professionals or those that aspire to become one. In view of the high demands of international events, the "Silverlite Pro" covers all the special requirements of professionals in a single rod series. Competitions are often decided by the fish that were not lost. Ultra-soft in the fight yet with sufficient power to control fish perfectly. And light yet extremely robust. The "skeletal" SIC guides have been borrowed from the Sphere series and arranged perfectly to create an ideal symbiosis between the blank and rings. As light as a match rod, as powerful as a feeder rod – this rod series combines all of the positive characteristics of variety of rod models. The ultra-light Alps Rapid MVT carbon reel holder uses state of the art technology while the precise vibration transfer from the blank enables optimal reaction speed. The reel is held securely in two places via two screw threads. The rod sits perfectly in the hand and enables effortless, fatigue-free fishing for several hours. The tips have a diameter of just 2.2 mm, meaning that they are ultra-sensitive and indicate even the finest bites perfectly.

Code	Model	Length	Sections	C.W.	Tr.-Length	Weight
12214 330	Champion's Choice Silverlite Pro 3-3	3,30 m / 11'	2	55 g	1,68 m	151 g
12214 360	Champion's Choice Silverlite Pro 3-6	3,60 m / 12'	3	60 g	1,25 m	162 g
12214 390	Champion's Choice Silverlite Pro 3-9	3,90 m / 13'	3	80 g	1,35 m	189 g

Code	Model	provided Feeder Tips
12214 330	Champion's Choice Silverlite Pro 3-3	0,5 oz, 0,75 oz, 1 oz
12214 360	Champion's Choice Silverlite Pro 3-6	0,5 oz, 0,75 oz, 1 oz
12214 390	Champion's Choice Silverlite Pro 3-9	1 oz, 1,5 oz, 3 oz







## BLACK VIPER 2



### Black Viper II Spare Tip

Code	Model	Length	Testcurve
12204 001	Glass fibre	0,60 m	0,5 oz
12204 002	Glass fibre	0,60 m	0,75 oz
12204 003	Glass fibre	0,60 m	1 oz
12204 004	Carbon	0,60 m	1,5 oz
12204 005	Carbon	0,70 m	1 oz
12204 006	Carbon	0,70 m	1,5 oz
12204 007	Carbon	0,70 m	2 oz
12204 008	Carbon	0,70 m	3 oz
12204 009	Carbon	0,70 m	4 oz
12204 010	Carbon	0,70 m	5 oz
12204 011	Carbon	0,70 m	6 oz
12204 012	Carbon	0,70 m	7 oz



### Black Viper II MK12

Perfect for anglers needing a slightly "stepped-up" feeder rod, this deceptively powerful 12' / 3.6m rod is designed for fishing medium feeders at ranges to around 60m on lakes, rivers or the big continental canals. The slim high-modulus blank has power in the middle and lower sections allowing feeders to be "punched" out with high accuracy. However it retains a forgiving top section for playing fish at close range. Slim, light and good looking with top quality fittings.

Code	Model	Length	Sections	C.W.	Tr.-Length	Weight
12204 360	Black Viper II MK12	3,60 m / 12'	3	80 g	1,26 m	276 g

Code	Model	provided Feeder Tips
12204 360	Black Viper II MK12	0,75, 1,0, 1,5 oz

### Black Viper II MK13

We offer two different versions of the 13' Black Viper rod. The standard MK13 has an average action typical of 13' rods and is perfectly suited to slow-flowing rivers and lakes with typical casting ranges of 30 to 80 metres. The mellow action allows light hook-lengths to be used with confidence. The Black Viper MK13 "S" is a fast actioned, more specialist version, which provides the power for casts up to around 100m without sacrificing its fish playing action. The dynamic design of the blank does all the work on the cast - meaning less effort is required from the angler. Long casts can be achieved even by anglers less experienced at long distance casting. Both rods are balanced for their length and feel as good as they look. Top quality fittings throughout.

Code	Model	Length	Sections	C.W.	Tr.-Length	Weight
12204 390	Black Viper II MK13	3,90 m / 13'	3	100 g	1,35 m	315 g
12204 391	Black Viper II MK13 S	3,90 m / 13'	3	140 g	1,35 m	340 g

Code	Model	provided Feeder Tips
12204 390	Black Viper II MK13	1,5, 2,0, 3,0 oz
12204 391	Black Viper II MK13 S	2,0, 3,0, 4,0 oz

### Black Viper II MK14

Like the Black Viper MK13, the 14' version is also available in two types. The standard Black Viper MK14 is the ultimate casting tool. Far, further ... furthest - you will never be out-distanced ! The high-modulus blank is powerful and designed for comfortable casting to distances of 70 to 120 m. Our dynamic blank designs throughout the range eliminate the need for violent, aggressive casts. Accurate casting to over 100m is both realistic and easily achievable with these rods. The Black Viper MK14 "S" version is the ultimate powerhouse, with the same attributes as the standard MK14 rod, but with even more power for when big heavily loaded feeders are needed.

Code	Model	Length	Sections	C.W.	Tr.-Length	Weight
12204 420	Black Viper II MK14	4,20 m / 14'	3	120 g	1,45 m	355 g
12204 421	Black Viper II MK14 S	4,20 m / 14'	3	160 g	1,45 m	375 g

Code	Model	provided Feeder Tips
12204 420	Black Viper II MK14	2,0, 4,0, 5,0 oz
12204 421	Black Viper II MK14 S	3,0, 4,0, 5,0 oz

### Black Viper II MK15

For extreme feeder situations, the Black Viper MK15 comes into its own: Despite its light weight and astounding slim blank, this rod has so much power that no feeder is too heavy! Feeders of over 250 g are handled with ease. This makes the Black Viper MK15 ideal for large continental rivers such as the Danube, Rhine and Main.

Code	Model	Length	Sections	C.W.	Tr.-Length	Weight
12204 450	Black Viper II MK15	4,50 m / 15'	3	250 g	1,56 m	429 g

Code	Model	provided Feeder Tips
12204 450	Black Viper II MK15	3,0, 4,0, 5,0 oz





# KING Feeder



## King Feeder Quiver Tip

Code	Model	Length	Testcurve
12201 001	Carbon	0,70 m	1 oz
12201 002	Carbon	0,70 m	1,5 oz
12201 003	Carbon	0,70 m	2 oz
12201 004	Carbon	0,70 m	2,5 oz
12201 005	Carbon	0,70 m	3 oz
12201 006	Carbon	0,70 m	4 oz
12201 007	Carbon	0,70 m	5 oz



## King Feeder Ultralight/Braid

These rods have been specifically designed for fishing with non-stretch braided lines - which need soft action rods to prevent hooks pulling from fish. The high-carbon blanks retain enough "backbone" for casting feeders, but have a forgiving through-action, which is equally useful for fishing with fine hooklengths for soft mouthed bream. Available in two lengths.

Code	Model	Length	Sections	C.W.	Tr.-Length	Weight
12201 331	King Feeder Ultralight/Braid	3,30 m / 11'	2	30 - 60 g / 3 - 6 lbs	1,68 m	213 g
12201 360	King Feeder Ultralight/Braid	3,60 m / 12'	2	30 - 60 g / 3 - 6 lbs	1,25 m	230 g

Code	Model	provided Feeder Tips
12201 331	King Feeder Ultralight/Braid	0,75 oz, 1,0 oz, 1,5 oz
12201 360	King Feeder Ultralight/Braid	1 oz, 1,5 oz, 2 oz

## King Feeder Multi-Length

These slim and light rods have classic soft & medium actions for typical medium distance feeder fishing on lakes and slow flowing rivers. The light rod is perfect for skimmers on light tackle. The medium version has more power in the lower sections for longer casting and/or bigger feeders. These are good "do everything" rod for anglers looking for a general purpose feeder rods. Range includes a practical 11'/13' multi-length rod. The base 11' / 3.30m rod is perfect for close to mid range fishing, including for match sized carp. The rod's "medium" action is maintained at both lengths, making it the perfect all-round feeder rod.

Code	Model	Length	Sections	C.W.	Tr.-Length	Weight
12201 330	King Feeder Multi-Length	3,30 - 3,90 m	2	60 g / 3 - 6 lbs	1,35 m	250 g
12201 361	King Feeder Light/Stillwater	3,60 m / 12'	3	80 g / 3 - 6 lbs	1,25 m	252 g
12201 362	King Feeder Medium/River	3,60 m / 12'	3	100 g / 3 - 8 lbs	1,25 m	249 g
12201 363	King Feeder Power/River	3,60 m / 12'	3	140 g / 5 - 10 lbs	1,25 m	265 g

Code	Model	provided Feeder Tips
12201 330	King Feeder Multi-Length	1 oz, 1,5 oz, 2 oz
12201 361	King Feeder Light/Stillwater	1 oz, 1,5 oz, 2 oz
12201 362	King Feeder Medium/River	1,0 oz, 1,5 oz, 2,0 oz
12201 363	King Feeder Power/River	2oz, 3oz, 4oz

## King Feeder Distance/River

These are the "stepped up" members of the King Feeder rod family. Still very light and slim, they have medium to heavy actions for when extra power is needed for more powerful rivers or casting heavier feeders longer distances. However, the blank has been carefully designed so that they are still forgiving enough to be used for bream etc. There are two 13' / 3.9m versions for when extra length is needed for longer casts and/or use on wider rivers.

Code	Model	Length	Sections	C.W.	Tr.-Length	Weight
12201 390	King Feeder Distance/River	3,90 m / 13'	3	100 g / 3 - 8 lbs	1,36 m	289 g
12201 391	King Feeder Distance/Power	3,90 m / 13'	3	140 g / 3 - 8 lbs	1,36 m	314 g

Code	Model	provided Feeder Tips
12201 390	King Feeder Distance/River	1,5 oz, 2,0 oz, 3,0 oz
12201 391	King Feeder Distance/Power	2 oz, 3 oz, 4 oz

## King Feeder Ultra Distance

The "Kings" of long casting. Two powerful 14'/4.2m rods that will cast feeders to the horizon ! Both rods are also perfect for very large and powerful rivers where the extra length helps keep the line off the water and helps control hard fighting fish in strong currents. Designed for situations or anglers that need a long and very powerful feeder rod that will cope with the biggest cast with the biggest feeder on the biggest lake or river. The "Big Daddies" of powerful feeder rods!

Code	Model	Length	Sections	C.W.	Tr.-Length	Weight
12201 420	King Feeder Ultra Distance	4,20 m / 14'	3	120 g / 3 - 8 lbs	1,46 m	370 g
12201 421	King Feeder Ultra Distance Power	4,20 m / 14'	3	160 g / 3 - 8 lbs	1,46 m	399 g

Code	Model	provided Feeder Tips
12201 420	King Feeder Ultra Distance	1 oz, 1,5 oz, 2 oz
12201 421	King Feeder Ultra Distance Power	1 oz, 1,5 oz, 2 oz

kompletný cenník na [www.SPORTS.sk](http://www.SPORTS.sk), výhradný distribútor pre SR: SPORTS s.r.o.





## Black Magic® SLF Stillwater Feeder M

Excellent feeder rod set with an optimal price-performance ratio. The slimline, weight-saving SIC rings are particularly attractive. They also make the slender blanks with mortise and tenon joints extraordinarily sensitive and sprightly. With Fuji reel holder. Feeder rods in this price segment have never been better. The stillwater models are ideally suited to fishing on lakes and canals.

Code	Model	Length	Sections	C.W.	Tr.-Length	Weight
12208 330	Black Magic® SLF Stillwater Feeder M	3,30 m / 11'	2	80 g	1,71 m	219 g
12208 360	Black Magic® SLF Stillwater Feeder M	3,60 m / 12'	3	90 g	1,26 m	262 g

Code	Model	provided Feeder Tips
12208 330	Black Magic® SLF Stillwater Feeder M	0.5oz 60cm, 0.75cm 60cm, 1.0oz 60cm
12208 360	Black Magic® SLF Stillwater Feeder M	0.75oz 60cm, 1.0cm 60cm, 1.5oz 60cm



## Black Magic® SLF Quivertip

Code	Model	Length	Testcurve
12208 001	Carbon	70,00 cm	0,5 oz
12208 002	Carbon	70,00 cm	0,75 oz
12208 003	Carbon	70,00 cm	1 oz
12208 004	Carbon	70,00 cm	1,5 oz
12208 005	Carbon	70,00 cm	2 oz
12208 006	Carbon	70,00 cm	3 oz
12208 007	Carbon	70,00 cm	4 oz
12208 008	Carbon	60,00 cm	0,5 oz
12208 009	Carbon	60,00 cm	0,75 oz
12208 010	Carbon	60,00 cm	1,00 oz
12208 011	Carbon	60,00 cm	1,50 oz

## Black Magic® SLF River Feeder MH

Excellent feeder rod set with an optimal price-performance ratio. The slimline, weight-saving SIC rings are particularly attractive. They also make the slender blanks with mortise and tenon joints extraordinarily sensitive and sprightly. With Fuji reel holder. Feeder rods in this price segment have never been better. The river models are ideally suited to fishing on medium to fast-flowing waters.

Code	Model	Length	Sections	C.W.	Tr.-Length	Weight
12209 360	Black Magic® SLF River Feeder MH	3,60 m / 12'	3	120 g	1,26 m	288 g
12209 390	Black Magic® SLF River Feeder MH	3,90 m / 13'	3	120 g	1,35 m	310 g
12209 420	Black Magic® SLF River Feeder MH	4,20 m / 14'	3	120 g	1,46 m	335 g

Code	Model	provided Feeder Tips
12209 360	Black Magic® SLF River Feeder MH	0.75oz 60cm, 1.0cm 60cm, 1.5oz 60cm
12209 390	Black Magic® SLF River Feeder MH	1.5oz 70cm, 2.0cm 70cm, 3.0oz 70cm
12209 420	Black Magic® SLF River Feeder MH	1.5oz 70cm, 2.0cm 70cm, 3.0oz 70cm



## Black Magic® SLF Feeder Distance

Excellent feeder rod set with an optimal price-performance ratio. The slimline, weight-saving SIC rings are particularly attractive. They also make the slender blanks with mortise and tenon joints extraordinarily sensitive and sprightly. With Fuji reel holder. Feeder rods in this price segment have never been better. The Distance feeder models are ideally suited to fishing at long range when swimfeeders have to be catapulted over maximum distances.

Code	Model	Length	Sections	C.W.	Tr.-Length	Weight
12210 390	Black Magic® SLF Feeder Distance	3,90 m / 13'	3	150 g	1,65 m	326 g
12210 420	Black Magic® SLF Feeder Distance XT	4,20 m / 14'	3	160 g	1,46 m	383 g

Code	Model	provided Feeder Tips
12210 390	Black Magic® SLF Feeder Distance	2.0oz 70cm, 3.0cm 70cm, 4.0oz 70cm
12210 420	Black Magic® SLF Feeder Distance XT	2.0oz 70cm, 3.0cm 70cm, 4.0oz 70cm





## Jens Koschnick World Champion Feeder Spare Tip

Code	Model	Length	Testcurve
12211 001	Carbon	60,00 cm	0,75 oz
12211 002	Carbon	60,00 cm	1,00 oz



## Hyper Carp Method Quiver Tip

Code	Model	Length	Testcurve
12216 002	Carbon	59,00 cm	1,00 oz
12216 001	Carbon	59,00 cm	0,75 oz
12216 003	Carbon	59,00 cm	1,50 oz



## Jens Koschnick World Champion Feeder

Browning angler Jens Koschnick became team world champion and pairs winner with this rod series. The extremely robust blank is slender, light and offers the angler an incredible parabolic action! Jens considers it the most versatile rod in our range. Whether fishing with the lightest feeders for bream and roach with ultra-soft tips, using heavy feeders for hybrids in Ireland or Method fishing on commercial waters – this rod will not let you down! With its cushioning action, the World Champion Feeder can also be used with braided line throughout. The perfect rod for casting distances up to 50 m and casting weights up to 50 g! Available in lengths of 3.30 m (11') and 3.60 m (12').

Code	Model	Length	Sections	C.W.	Tr.-Length	Weight
12211 330	Jens Koschnick World Champion Feeder	3,30 m / 11'	2	50 g	1,69 m	165 g
12211 360	Jens Koschnick World Champion Feeder	3,60 m / 12'	2	50 g	1,84 m	180 g

Code	Model	provided Feeder Tips
12211 330	Jens Koschnick World Champion Feeder	0,75 oz, 1,0 oz
12211 360	Jens Koschnick World Champion Feeder	0,75 oz, 1,0 oz

## Hyper Carp Method

Perfectly suited to fishing the "Method", this rod series is sure to find many passionate fans in no time. The slender, rapid blank of the Hyper Carp Method series was deliberately divided into three sections during development to allow targeted optimisation. The top section impresses via the use of thin yet solid carbon tips that indicate even the most sensitive bites reliably, giving even the most cautious fish no grounds for suspicion. The lower section featuring the handle provides captivating power that enables precise casting with relatively little effort and controlled fighting even with the largest carp. Finally, the middle section with its harmonious transitions, creates the perfect link and skilfully prevents unwanted pull-outs during a fight. As an added bonus, all tips in this series are also compatible with World Champion series rods.

Code	Model	Length	Sections	C.W.	Tr.-Length	Weight
12216 300	Hyper Carp Method	3,00 m / 10'	2	60 g	1,52 m	180 g
12216 330	Hyper Carp Method	3,30 m / 11'	2	60 g	1,68 m	200 g
12216 360	Hyper Carp Method	3,60 m / 12'	3	80 g	1,24 m	240 g
12216 361	Hyper Carp Method Distance	3,60 m / 12'	3	100 g	1,24 m	250 g

Code	Model	provided Feeder Tips
12216 300	Hyper Carp Method	0,75 oz, 1,0 oz, 1,5 oz
12216 330	Hyper Carp Method	0,75 oz, 1,0 oz, 1,5 oz
12216 360	Hyper Carp Method	0,75 oz, 1,0 oz, 1,5 oz
12216 361	Hyper Carp Method Distance	0,75 oz, 1,0 oz, 1,5 oz





## Argon Quivertip

Code	Model	Length	Testcurve
12215 001	Glass fibre	54,00 cm	0,75 oz
12215 002	Glass fibre	54,00 cm	1 oz
12215 003	Glass fibre	54,00 cm	1,5 oz
12215 004	Carbon	54,00 cm	1 oz
12215 005	Carbon	54,00 cm	1,5 oz
12215 006	Carbon	54,00 cm	2 oz
12215 007	Carbon	54,00 cm	3 oz
12215 008	Carbon	60,00 m	4 oz

## Argon Feeder

The 3 m (10') Argon Method Feeder is the perfect rod for the highly popular modern Method fishing techniques. The rod sets itself apart with highly sensitive fibreglass tips that guarantee reliable bite detection yet has sufficient backbone to handle big carp above the 10 kg mark with effortless ease. At the same time, the rod has a highly harmonious action that makes hook pull-outs almost impossible. Never has there been such a high quality Method rod at such an affordable price!

Code	Model	Length	Sections	C.W.	Tr.-Length	Weight
12215 300	MT	3,00 m / 10'	2	10 - 50 g	1,54 m	230 g

Code	Model	provided Feeder Tips
12215 300	MT	0,75 oz, 1,0 oz, 1,5 oz

## Argon Feeder

Argon Stillwater Feeder rods are available in two lengths (3.30 m and 3.60 m). With their harmonious yet very rapid action, they are perfectly suited to feeder fishing on lakes and canals. The equipment of the Argon feeder rods leaves nothing to be desired. SIC rings and a high-quality reel holder come as standard, as do cork and Duplon handles optimised for the rods.

Code	Model	Length	Sections	C.W.	Tr.-Length	Weight
12215 330	ST	3,30 m / 11'	2	25 - 75 g	1,70 m	279 g
12215 360	ST/R	3,60 m / 12'	3	20 - 60 g	1,25 m	290 g

Code	Model	provided Feeder Tips
12215 330	ST	0,75 oz, 1,0 oz, 1,5 oz
12215 360	ST/R	1,0 oz, 1,5 oz, 2,0 oz

## Argon Feeder

The four models in the Argon River Feeder series offer the ideal rod for every situation on rivers, whether fishing for roach on smaller rivers or targeting barbel in rapid currents. With the Argon River Feeder, you are always well prepared. The Argon River LD rod allows even the heaviest swimfeeders to be punched out reliably over long distances while the reliable blank offers sufficient reserves to tame even large barbel with effortless ease. The equipment of the Argon feeder rods leaves nothing to be desired. SIC rings and a high-quality reel holder come as standard, as do cork and Duplon handles optimised for the rods.

Code	Model	Length	Sections	C.W.	Tr.-Length	Weight
12215 361	R	3,60 m / 12'	3	30 - 90 g	1,26 m	288 g
12215 362	R/D	3,60 m / 12'	3	40 - 120 g	1,27 m	268 g
12215 390	R/D	3,90 m / 13'	3	30 - 90 g	1,36 m	329 g
12215 391	R/LD	3,90 m / 13'	3	50 - 150 g	1,36 m	336 g

Code	Model	provided Feeder Tips
12215 361	R	1,0 oz, 1,5 oz, 2,0 oz
12215 362	R/D	1,0 oz, 2,0 oz, 3,0 oz
12215 390	R/D	1 oz, 2 oz, 3 oz
12215 391	R/LD	2 oz, 3 oz, 4 oz



In 2010 Browning were amongst the very first to offer new styles of short rod which challenged the need for traditional length rods on commercial fisheries. Our Force 8' Wand and 9' Micro Wagglers were big sellers and soon copied. We have refined our designs further to stay „ahead of the game“. The result is our range of 13 Commercial King rods. These rods are based around ultra slim and light high modulus full carbon blanks. We have carefully considered every aspect of the rod, not just the action. They are absolutely perfect and look superb! These rods are typically HALF the cost of similar quality rods from other suppliers. We challenge anybody to find an equal performing rod at these prices. The Commercial King range has been further improved and refined.

## COMMERCIAL KING<sup>2</sup>



### Commercial King<sup>2</sup> Wand

Try one of these and you will never use a long rod again! The ultimate rods for close range tip fishing. The 8' length dramatically improves accuracy and lands fish incredibly quickly. Forgiving through actions but power in the butt so can be a real „bagging“ rod. The F1 version is around 20% softer and is perfect for winter carp fishing with light lines and small hooks. Both supplied with 3 glass tips (0,5 oz, 1 oz, 1,5 oz).

Code	Model	Length	Sections	C.W.	Tr-Length	Weight
1877 245	Commercial King <sup>2</sup> Wand	2,45 m / 8,1"	2	3 - 8 lbs	1,28 m	170 g
1877 246	Commercial King <sup>2</sup> Wand F1	2,45 m / 8,1"	2	2 - 4 lbs	1,28 m	155 g
1877 270	Commercial King <sup>2</sup> Wand XL	2,70 m / 9'	2	3 - 8 lbs	1,41 m	190 g

Code	Model	provided Feeder Tips
1877 245	Commercial King <sup>2</sup> Wand	0.5 oz, 1 oz, 1.5 oz
1877 246	Commercial King <sup>2</sup> Wand F1	0.5 oz, 1 oz, 1.5 oz
1877 270	Commercial King <sup>2</sup> Wand XL	0.5 oz, 1 oz, 1.5 oz

### Commercial King<sup>2</sup> Bomb

The classic 10', 2 piece „bomb“ rod. A rod that can be used for just about anything – feeder, bomb, method, winter scratching or big summer catches. Powerful enough for carp but forgiving enough for skimmers, light lines and small hooks. Short handle length for ease of use. Supplied with 3 glass tips (1,0 oz, 1,5 oz, 2,0 oz).

Code	Model	Length	Sections	C.W.	Tr-Length	Weight
1878 300	Commercial King <sup>2</sup> Bomb	3,00 m / 10'	2	3 - 6 lbs	1,55 m	220 g

Code	Model	provided Feeder Tips
1878 300	Commercial King <sup>2</sup> Bomb	1.0 oz, 1.5 oz, 2 oz

### Commercial King<sup>2</sup> Carp Feeder

Classic through actioned rod for fishing at medium range. The 2 piece rod has power in the butt section for casting and landing fish quickly, but retains a softer action in the middle essential to eliminate hook-pulls when playing hard fighting carp at close range. Suitable for feeders to around 40gr, hook-lengths to 0.22mm and is supplied with 3 glass tips (1,0 oz, 1,5 oz, 2,0 oz).

Code	Model	Length	Sections	C.W.	Tr-Length	Weight
1878 330	Commercial King <sup>2</sup> Carp Feeder	3,30 m / 11'	2	3 - 8 lbs	1,70 m	255 g

Code	Model	provided Feeder Tips
1878 330	Commercial King <sup>2</sup> Carp Feeder	1.0 oz, 1.5 oz, 2 oz

kompletný cenník na [www.SPORTS.sk](http://www.SPORTS.sk), výhradný distribútor pre SR: SPORTS s.r.o.





## Commercial King² Micro Wagglers

Long rods – who needs them? The „must have“ for commercial anglers: Short handles and feather light weight make these short rods unbelievably fast and accurate to fish with. They are simply unbeatable for short to medium distances. The 9' rod is deceptively powerful and tames even big fish very quickly. The 10' F1 version is around 20% softer and perfect for smaller floats, lighter lines and smaller hooks. These rods are natural partners for our Wand tip rods.

Code	Model	Length	Sections	C.W.	Tr.-Length	Weight
1879 270	Wagglers	2,70 m / 9'	2	20 g	1,40 m	160 g
1879 300	Wagglers F1	3,00 m / 10'	2	10 g	1,55 m	170 g

## Commercial King² Pellet Waggler

2 piece, 11' rods with perfect, parabolic, „non-lock“ actions. Shorter than normal handles allow the rods to be moved around quickly for „feed-cast-feed“ techniques. The medium rod has a standard action for wagglers to 12gr. The Power version is around 15% stiffer for situations involving bigger floats, bigger fish or bigger weights!

Code	Model	Length	Sections	C.W.	Tr.-Length	Weight
1879 330	Medium	3,30 m / 11'	2	20 g	1,70 m	190 g
1879 331	Power	3,30 m / 11'	2	30 g	1,70 m	205 g

## Commercial King² Carp Tickler

A revolutionary new rod design that takes "short" commercial rods to the next level. The Tickler rods effectively a one piece 7' rod which is "folded" for carrying by just pulling out the quivertip, placing the hook in a special keeper tube and winding the line tight. Everything is held in place without the need for any rod bands or sleeves. The rods can be set up and "ready to fish" in less than 10 seconds - and put away just as quickly - without the irritating tangles and damaged quivertips always suffered with transporting a made-up conventional 2 piece rod. As the main rod is in one piece and has no joints the action is absolutely perfect. The 7' length further improves casting accuracy compared to even 8's rods, and brings even big fish to you feet and ready to net very quickly. Even if you are already a "short rod convert", just try one of these and you will never go back to your difficult to assemble "long" 8 or 9' rod. Two versions to suit Carp/F1, or summer/winter, fishing.

Code	Model	Length	Sections	C.W.	Tr.-Length	Testcurve	Weight
12206 220	Carp	2,20 m / 7'	1+1	50 g / 3 - 8 lbs	1,70 m		140 g
12206 221	F1	2,20 m / 7'	1+1	35 g / 2 - 4 lbs	1,70 m		135 g
12206 001	Commercial King Tickler Quiver Tip	53,00 cm				0,5 oz	
12206 002	Commercial King Tickler Quiver Tip	53,00 cm				1,0 oz	

Code	Model	provided Feeder Tips
12206 220	Carp	0.50 oz, 1 oz
12206 221	F1	0.50 oz, 1 oz
12206 001	Commercial King Tickler Quiver Tip	
12206 002	Commercial King Tickler Quiver Tip	





## Commercial King² Quickfish

A totally new design concept which allows a rod to be assembled and "ready to fish" in less than 15 seconds. Completely eliminates the irritating tangles and damaged quivertips suffered when carrying and assembling a conventional 2 or 3 piece rod. Just push in the quivertip, extend the lower telescopic section and you are fishing! The unique mix of a long top section and extending butt section provides a perfect parabolic rod action with absolutely no flatspots. A unique hook storage tube is fitted which protects and prevents the hook snagging the bag and keeps the end tackle tidy. The CK Quickfish rods are available in 2 lengths, a 10'3m Bomb rod and a 11'3.3m Carp Feeder rod, both perfect for method feeder techniques. Like all CK rods, they have perfect actions, quality fittings and a stunning finish.

Code	Model	Length	Sections	C.W.	Tr.-Length	Weight
12205 300	Bomb	3,00 m / 10'	3	3 - 6 lbs	1,70 m	150 g
12205 330	Feeder	3,30 m / 11'	4	20 - 60 g	1,56 m	184 g

Code	Model	provided Feeder Tips
12205 300	Bomb	1,0oz, 1,5oz
12205 330	Feeder	1,0oz, 1,5oz



## Black Magic® Competition Float

New, beautifully light actioned float rods designed for mixed fishing. Perfect for waggler fishing. This slim and very light rod has a faultless progressive action, which allows even bigger fish to be landed on light lines. The perfect all-rounder for light tackle fishing on rivers and lakes.

Code	Model	Length	Sections	C.W.	Tr.-Length	Weight
12001 390	Black Magic® Competition Float	3,90 m / 13'	3	20 g	1,36 m	190 g
12001 420	Black Magic® Competition Float	4,20 m / 14'	3	20 g	1,45 m	216 g



## Black Magic® Competition Pellet Waggler

A beautifully light and slim 2 piece rod with the classic "all-through action" needed for this type of fishing for carp or bigger fish. Built using top quality fittings and fitted with a short handle. Of course, Black Magic strength come as standard! Also makes a perfect rod for general fishing on small rivers and lakes.

Code	Model	Length	Sections	C.W.	Tr.-Length	Weight
12003 330	Black Magic® Competition Pellet Waggler	3,30 m / 11'	2	20 g / 3 - 8 lbs	1,56 m	295 g



## Black Magic® C-Distance II

The longer version of the Black Magic Competition feeder rods for fishing at extreme distances or on fast-flowing rivers. Hard on the take and does not shy away from difficult situations.

Code	Model	Length	Sections	C.W.	Tr.-Length	Weight
12222 390	Black Magic® C-Distance II	3,90 m / 13'	1+1	120 g	1,37 m	447 g

Code	Model	provided Feeder Tips
12222 390	Black Magic® C-Distance II	3oz, 4oz





## Black Magic® C-Picker II

A range of three quality carbon rods mainly designed for match-sized carp, but also good for small rivers. The 8' / 2.5m "Picker" makes accurate casting to around 25m easier and fish can be landed very quickly. The classic 10'3.0m "Bomb" and 11'3.3m Light Feeder are adaptable rods suitable for the method or conventional feeder fishing for a wide range of fish, winter or summer, due to their forgiving "all-through" actions. These rods are really enjoyable to use as they are so sensitive and light when playing fish. All are supplied with 2 quivertips.

Code	Model	Length	Sections	C.W.	Tr.-Length	Weight
12220 250	Picker	2,50 m / 8,2"	2	50 g	1,30 m	210 g
12220 300	Bomb	3,00 m / 10'	2	80 g	1,54 m	262 g
12220 330	Bomb	3,30 m / 11'	2	80 g	1,70 m	297 g

Code	Model	provided Feeder Tips
12220 250	Picker	1oz, 2oz
12220 300	Bomb	1oz, 2oz
12220 330	Bomb	1oz, 2oz



## Black Magic® C-II Feeder Tip

Code	Model	Length	Testcurve
12220 001	Glass fibre	62,00 cm	1 oz
12220 002	Glass fibre	62,00 cm	2 oz
12220 003	Glass fibre	62,00 cm	3 oz
12220 004	Carbon	62,00 cm	4 oz

## Black Magic® C-Stillwater L II

These are general purpose, "do anything", carbon feeder rods that will handle every form of feeder fishing. If you only want one rod for all your feeder fishing, rivers and lakes, then choose one of these! Capable of casting larger feeders over good distances, but still soft enough for use at close distances with light lines for smaller fish. Supplied with 2 quivertips.

Code	Model	Length	Sections	C.W.	Tr.-Length	Weight
12221 360	Black Magic® C-Stillwater L II	3,60 m / 12'	3	80 g	1,25 m	340 g

Code	Model	provided Feeder Tips
12221 360	Black Magic® C-Stillwater L II	1oz, 2oz



## Black Magic® C-River M II

These are general purpose, "do anything", carbon feeder rods that will handle every form of feeder fishing. If you only want one rod for all your feeder fishing, rivers and lakes, then choose one of these! Capable of casting larger feeders over good distances, but still soft enough for use at close distances with light lines for smaller fish. The River Feeder version is designed for bigger feeders, bigger fish and, if needed, longer casts so is good if using large method feeders, or on powerful rivers where the rod needs to have some "backbone" and take some abuse! Supplied with 2 quivertips.

Code	Model	Length	Sections	C.W.	Tr.-Length	Weight
12222 360	Black Magic® C-River M II	3,60 m / 12'	3	100 g	1,28 m	398 g

Code	Model	provided Feeder Tips
12222 360	Black Magic® C-River M II	1oz, 3oz





OUT OF THIS WORLD!

## Sphere MgTi

Fantastic match and feeder reel series with ultra-light magnesium body! The rotor is reinforced with carbon fibre, the titanium axle is indestructible and the line guide has been coated with titanium for durability and optimal line protection. This series offers the right size reel for every application in modern coarse angling.

### Standard Technical Equipment:

- Rotor in C4LF™ Carbon
- Ultra-light magnesium housing
- Front drag with Magnum carbon drag discs
- Slimline handle
- Titanium-nitride-coated line roller with anti-twist system
- Thick bail arm for optimal balance
- Extra-strong stainless steel main shaft
- Duraluminium spool with anodized front edge and anti-slip spool core
- Spare spool with special Anti-Slip-Core for braids
- Two-speed oscillation system
- Rapid line retrieval
- Continuous anti-reverse
- Outstanding line protection line clip



Code	Model	m / mm	Gear Ratio	Retrieve	BB	Drag F.	Weight
0317 020	920	100 / 0,15	5,0:1	82 cm	9	6,4 kg / 14 lbs	240 g
0317 030	930	100 / 0,20	5,0:1	92 cm	9	6,4 kg / 14 lbs	250 g
0317 040	940	110 / 0,20	4,6:1	89 cm	9	7,7 kg / 17 lbs	338 g
0317 050	950	140 / 0,20	4,6:1	95 cm	9	7,7 kg / 17 lbs	343 g

Spare Spool	Model	Material
0988 126	Sp. Spool Sphere MgTi 920	Alu
0988 127	Sp. Spool Sphere MgTi 930	Alu
0988 128	Sp. Spool Sphere MgTi 940	Alu
0988 129	Sp. Spool Sphere MgTi 950	Alu



## King WS FD

The reel series impresses with optimal line distribution thanks to the worm-shaft gears. The metal body makes the reel incredibly robust, ensuring a long service life. The Triple Gear Drive increases power transfer tremendously and makes this reel series a reliable partner for feeder anglers.

### Standard Technical Equipment:

- Electronically balanced lightweight rotor (LWR)
- Aluminium body and sidecovers
- Large-surface multi-disc front drag system
- CNC stainless steel handle
- Anti-twist line roller
- Thick bail arm for optimal balance
- Robust worm shaft power gears
- Shallow aluminium spare spool
- Wormshaft oscillation system
- Continuous anti-reverse



Code	Model	m / mm	Gear Ratio	Retrieve	BB	Drag F.	Weight
0336 030	730	180 / 0,16	5,0:1	71 cm	7	5,0 kg / 11 lbs	270 g
0336 040	740	240 / 0,16	5,0:1	91 cm	7	5,9 kg / 13 lbs	390 g

Spare Spool	Model	Material
0988 130	Sp. Spool King WS 730	Alu
0988 131	Sp. Spool King WS 740	Alu



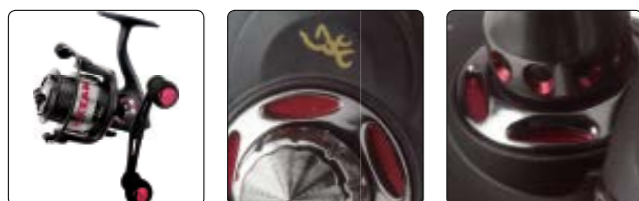

Double Handle included.



## Xitan MF

Impressive reel with large spool diameter for match angling. The ultra-smooth and progressive carbon drag system and carbon handle, with an additional double handle supplied, will satisfy even the most demanding match angler. The specially designed line clip has a protective coating to prevent line damage. The line roller runs on ball bearings making the reel incredibly smooth and powerful.

### Standard Technical Equipment:

- Finely adjustable front drag
- Non-twist line roller supported by ball bearings
- Shallow aluminium spool
- Shallow aluminium spare spool
- Continuous anti-reverse



Code	Model	m / mm	Gear Ratio	Retrieve	BB	Drag F.	Weight
0287 030	930	150 / 0,18	6.0:1	105 cm	9	5,9 kg / 13 lbs	289 g
0287 040	940	150 / 0,23	6.0:1	110 cm	9	5,9 kg / 13 lbs	305 g

Spare Spool	Model	Material
0988 115	match	Alu
0988 116	match	Alu

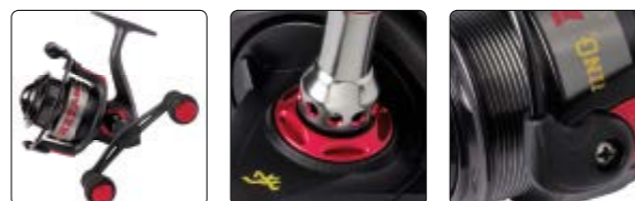

## Xitan MF Slow Gear

Impressive reel with large spool diameter for match angling. The ultra-smooth and progressive carbon drag system and carbon handle with an additional double handle supplied will satisfy even the most demanding match angler. The specially designed line clip has a protective coating to prevent line damage. The line roller runs on ball bearings making the reel incredibly smooth and powerful.

### Standard Technical Equipment:

- Balanced rotor, producing silky smooth action
- Finely adjustable front drag
- Non-twist line roller supported by ball bearings
- Thick bail arm for optimal balance
- Smooth gears with even line distribution
- Shallow aluminium spool
- Shallow aluminium spare spool
- Continuous anti-reverse



Code	Model	m / mm	Gear Ratio	Retrieve	BB	Drag F.	Weight
0287 130	930 SG	150 / 0,18	5,0:1	86 cm	9	5,9 kg / 13 lbs	286 g
0287 140	940 SG	150 / 0,23	5,0:1	89 cm	9	5,9 kg / 13 lbs	302 g

Spare Spool	Model	Material
0988 115	match	Alu
0988 116	match	Alu





## Black Viper Long Ranger

The Monster Feeder Reel: When it comes to feeder fishing at ultra-long distances, you need a large enough feeder reel with a sufficient retrieve speed for checking the bait and re-filling the feeder. At the same time, the gears have been produced in sufficient size to withstand the huge stresses created by constantly reeling in with a load. The ultimate weapon for long-range feeder anglers.

### Standard Technical Equipment:

- Balanced rotor, producing silky smooth action
- Large-surface multi-disc front drag system
- CNC stainless steel handle
- Anti-twist line roller
- Robust worm shaft power gears
- Ultra-light skeleton spool
- Continuous anti-reverse



Code	Model	m / mm	Gear Ratio	Retrieve	BB	Drag F.	Weight
0311 055	855	300 / 0,16	4,6:1	94 cm	8	8,2 kg / 18 lbs	558 g

Spare Spool	Model	m / mm	Material
0988 132	Sp.Spool Black Viper LR 855	300 / 0,16	Alu



## Black Viper MK FD

Browning have a lot of expertise in producing specialist tackle purpose designed for the long-distance feeder fishing which is common in mainland Europe. The Black Viper MK 850 FD is an example of a specialist reel packed with features specifically for medium to long-range feeder fishing. Sophisticated wormshaft gears have been used to ensure effortless retrieve and perfect line lay - particularly important for long-distance casting and when using braided lines. This is further enhanced by the large, wide and shallow spool design which can be perfectly filled without resorting to lots of backing. In summary, a purpose designed product that will out-perform conventional reels for this style of fishing.

### Standard Technical Equipment:

- Electronically balanced lightweight rotor (LWR)
- Large-surface multi-disc front drag system
- CNC stainless steel handle
- Non-twist line roller supported by ball bearings
- Robust worm shaft power gears
- Aluminium Long Stroke™ spool
- Aluminium spare spool
- Wormshaft oscillation system
- Continuous anti-reverse



Code	Model	m / mm	Gear Ratio	Retrieve	BB	Drag F.	Weight
0308 050	850	300 / 0,16	5,5:1	105 cm	8	5,9 kg / 13 lbs	430 g

Spare Spool	Model	m / mm	Material
0988 124	Sp.Spool Black Viper MK FD850	300 / 0,16	Alu





## Black Viper MK BF

Another member of the Black Viper MK 850 BF family of over-sized reels, with same specialist design, features and wormshaft gearing as the other two reels in the range, but incorporating a run control facility. An alternative to conventional carp-oriented run control reels. Perfect for long-distance fishing with finer lines or braid for species like bream and tench.

### Standard Technical Equipment:

- Electronically balanced lightweight rotor (LWR)
- Large-surface multi-disc front drag system
- Finely adjustable run control system
- CNC stainless steel handle
- Non-twist line roller supported by ball bearings
- Robust worm shaft power gears
- Aluminium Long Stroke™ spool
- Aluminium spare spool
- Wormshaft oscillation system
- Continuous anti-reverse



Code	Model	m / mm	Gear Ratio	Retrieve	BB	Drag F.	Weight
0309 050	850	300 / 0,16	5,5:1	105 cm	8	5,9 kg / 13 lbs	470 g

Spare Spool	Model	Material
0988 125	Sp.Spool Black Viper BF850	Alu

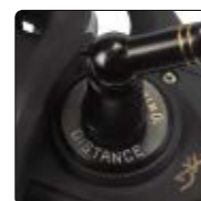

## Black Magic® Max Distance

Feeder fishing at 100 meters distance? Unthinkable some years ago, now a standard distance for many pros. However, rather than resorting to a traditional surf reel, they should really take a closer look at the Black Magic Distance. Never has there been a more uncompromising feeder reel for extreme casting distances. Gear ratio, line capacity, spool design, transmission power: all have been optimized for this precise purpose. Test anglers were immediately impressed.

### Standard Technical Equipment:

- Balanced rotor, producing silky smooth action
- Oversized multi-stack drag system
- CNC stainless steel handle
- Anti-twist line roller
- Thick bail arm for optimal balance
- Aluminium Long Stroke™ spool
- Wormshaft oscillation system
- Continuous anti-reverse



Code	Model	m / mm	Gear Ratio	Retrieve	BB	Drag F.	Weight
0344 060	760	230 / 0,30	4,9:1	94 cm	7	7,0 kg / 15 lbs	565 g

Spare Spool	Model	m / mm
0988 136	Sp.Spool BM Distance 760	230 / 0,30



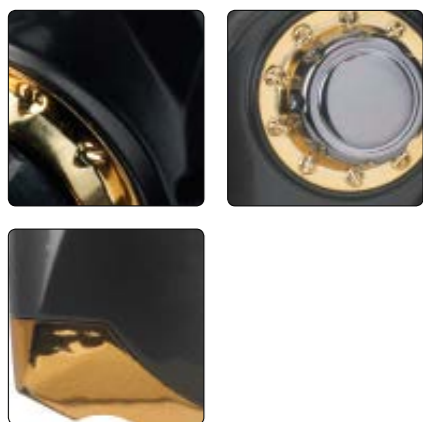

## Backfire II FD

A slick yet functional edition of the most successful Browning match reel in recent years. Its outstanding feature is the large diameter shallow spool which minimises the irritating and tangle causing coiling which often occurs when using thicker lines on small spools. The large spool also adds to casting distances. A compact and perfect reel for pellet waggler, bomb or small method feeder fishing.

### Standard Technical Equipment:

- Robust nylon housing
- Powerful multi-disc front drag system
- CNC stainless steel handle
- Deep aluminium spool
- Shallow aluminium spare spool
- S-curve line distribution
- Continuous anti-reverse



Code	Model	m / mm	Gear Ratio	Retrieve	BB	Drag F.	Weight
0285 030	830	180 / 0,20	5.1:1	95 cm	8	6,8 kg / 15 lbs	285 g
0285 040	840	130 / 0,30	5.1:1	97 cm	8	11,3 kg / 25 lbs	360 g

Spare Spool	Model	m / mm	Material
0988 109	Sp.Spool Backfire II FD830	180 / 0,20	Alu
0988 110	Sp.Spool Backfire II FD840	130 / 0,30	Alu

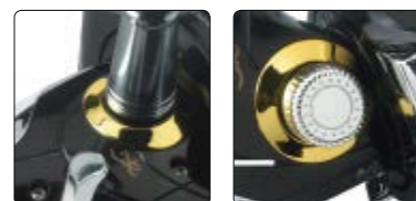

## Backfire II BF

All features of our Backfire FD reel but with the added benefit of a reliable run control system. Fans of run control reels have a choice of two sizes of Backfire, the larger size being perfect for heavy feeder, method and big waggler fishing. The big spool adds meters to casting distances with thick lines.

### Standard Technical Equipment:

- Robust nylon housing
- Powerful multi-disc front drag system
- Finely adjustable run control system
- CNC stainless steel handle
- Deep aluminium spool
- Shallow aluminium spare spool
- S-curve line distribution
- Continuous anti-reverse



Code	Model	m / mm	Gear Ratio	Retrieve	BB	Drag F.	Spare Spool	Weight
0286 030	830	190 / 0,25	5.1:1	95 cm	8	4,5 kg / 10 lbs	0988 111 / 0988 112	381 g
0286 040	840	180 / 0,30	5.1:1	97 cm	8	4,5 kg / 10 lbs	0988 113 / 0988 114	390 g

Spare Spool	Model	m / mm	Material
0988 111	deep	190 / 0,25	Alu
0988 112	match	100 / 0,20	Alu
0988 113	deep	180 / 0,30	Alu
0988 114	match	140 / 0,20	Alu





## Black Magic® FD

A good quality and durable front drag reel with all the advanced features needed when targeting quality fish. The ultra smooth and strong gear set is reliable when the pressure is on – these reels won't let you down. These reels look good with a classy, subdued finish that matches our superb Hybrid rods.

### Standard Technical Equipment:

- Graphite body
- Finely adjustable front drag
- CNC stainless steel handle
- Anti-twist line roller
- Thick bail arm for optimal balance
- Powerful gears
- Aluminium spool with hardened front edge for longer casting distances
- Spare spool
- S-curve line distribution
- Continuous anti-reverse



Code	Model	m / mm	Gear Ratio	Retrieve	BB	Drag F.	Weight
0342 020	420	155 / 0,16	5,1:1	59 cm	4	4,5 kg / 10 lbs	260 g
0342 030	430	120 / 0,22	5,1:1	62 cm	4	4,5 kg / 10 lbs	275 g
0342 040	440	120 / 0,28	4,8:1	64 cm	4	6,4 kg / 14 lbs	355 g

Spare Spool	Model
0988 133	Sp.Spool Black Magic® FD 420
0988 134	Sp.Spool Black Magic® FD 430
0988 135	Sp.Spool Black Magic® FD 440



## Black Magic® BF

The smoothness of the gears and free spool facility of the Black Magic BF is practically unbeatable. The ideal reel for feeder fishing on carp lakes that call for high-performance reels capable of withstanding heavy loads effortlessly. Highly versatile thanks to the free-spool system.

### Standard Technical Equipment:

- Finely adjustable front drag
- Finely adjustable run control system
- CNC stainless steel handle
- Anti-twist line roller
- Powerful gears
- Aluminium Long Stroke™ spool
- Spare spool
- S-curve line distribution
- Continuous anti-reverse



Code	Model	m / mm	Gear Ratio	Retrieve	BB	Drag F.	Weight
0353 030	630	180 / 0,20	5,0:1	71 cm	6	6,0 kg / 13 lbs	338 g
0353 040	640	200 / 0,25	4,6:1	90 cm	6	7,5 kg / 17 lbs	428 g

Spare Spool	Model	Material
0987 078	Sp.Spool Black Magic® BF 630	Nylon
0987 079	Sp.Spool Black Magic® BF 640	Nylon



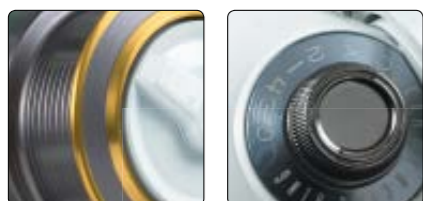

## Commercial King

Very compact but powerful reels designed for use with our Commercial King rods. The smaller size does not unbalance the light and short rods. Shallow spool, one-touch folding handle. sensitive "click-stop" vernier front drag, safe nylon line clip in a lined recess.

### Standard Technical Equipment:

- CarbonGraphite rotor
- Graphite body
- Finely adjustable front drag
- Folding aluminium handle
- Thick bail arm for optimal balance
- Powerful gears
- Aluminium Long Stroke™ spool
- Spare spool
- S-curve line distribution
- Continuous anti-reverse



Code	Model	m / mm	Gear Ratio	Retrieve	BB	Drag F.	Weight
0356 030	CK 2-430	180 / 0,16	5,2:1	75 cm	4	5,0 kg / 11 lbs	245 g
0356 040	CK 2-440	220 / 0,16	5,2:1	81 cm	4	5,0 kg / 11 lbs	303 g

Spare Spool	Model
0988 139	Sp.Spool CK2-430
0988 140	Sp.Spool CK2-440



## Argon FD

The perfect reel for our entry-level match and feeder rods. They may be economic but they work seamlessly! And they look great too! We are confident that these reels will break sales records.



Code	Model	m / mm	Gear Ratio	Retrieve	BB	Drag F.	Weight
0347 030	330	150 / 0,20	5,2:1	69 cm	3	4,5 kg / 10 lbs	290 g
0347 040	340	180 / 0,25	5,2:1	72 cm	3	4,5 kg / 10 lbs	408 g

### Standard Technical Equipment:

- Finely adjustable front drag
- Non-twist line roller
- Aluminium Long Stroke™ spool
- Spare spool
- S-curve line distribution

Spare Spool	Model
0988 137	Sp.Spool Argon 330 FD
0988 138	Sp.Spool Argon 340 FD



Screw fitting compatible with other popular brands



**Pole Cup Set**

Pole cups are now allowed in matches under CIPS rules making them indispensable in all forms of fishing. Available in a set containing the most common sizes. Marked with mil-litre measures to enable precise measuring of feed. Pole cups are fitted using the supplied adapters or with the special cupping kits (or power kits). Set includes 100ml, 150ml, 250ml.

**Code**  
6789 003  
Trade Pack 5 Pieces



**Multi Cupper**

Innovative cup variant allowing groundbait balls (top) and loose particles or baits (bottom) to be delivered to the swim. The lip of the cup has been designed to ensure the risk of bait tipping out is minimal.

**Code**    **Contents**  
6789 004    250 ml  
Trade Pack 5 Pieces



**Mini Cups**

Light weight, simple and very practical mini pole-cups with removable caps and wide slot size to fit large diameter tip sections up to 6.5mm. Pack contains 2 cups.

**Code**    **Model**  
6789 010    Small & Medium  
6789 011    Large  
Trade Pack 5 Pieces



**Xitan Pole Protector Bung**

Large EVA bungs which protect the ends of larger pole sections from chipping and other damage. Available in 3 primary sizes, however the joint area of the bung is slightly tapered so the EVA can be compressed to fit a wider range of section sizes.

**Code**    **Ø**  
6704 001    42 mm / 45 mm  
6704 002    45 mm / 47 mm  
6704 003    47 mm / 50 mm  
Trade Pack 5 Pieces



**Xitan Joint Protectors**

A range of medium grade EVA joint protectors. Fit into the male joints to prevent end damage and also keep female sections clear if grit etc. Sizes to fit Browning and most other popular poles. Should be secured with glue.

**Code**    **Ø**  
6704 005    16,5 mm  
6704 006    18 mm  
6704 007    21 mm  
6704 008    25 mm  
6704 009    30 mm  
6704 010    36 mm  
6704 011    39 mm  
6704 012    41 mm  
Trade Pack 5 Pieces



**Pole Caps**

You can simply never have enough of these for sealing poles, top kits and extensions.

**Code**    **Length**    **Ø**  
6787 001    20,5 mm    20,5 mm  
6787 002    24,5 mm    24,5 mm  
6787 003    27,0 mm    27,0 mm  
6787 004    32,0 mm    32,0 mm  
6787 005    35,0 mm    35,0 mm  
6787 006    38,5 mm    38,5 mm  
6787 007    40,0 mm    40,0 mm  
6787 008    41,0 mm    41,0 mm  
6787 009    42,5 mm    42,5 mm  
6787 010    44,0 mm    44,0 mm  
6787 011    46,5 mm    46,5 mm  
Trade Pack 10 Pieces



**Hollow Carbon Tips**

Supplied in packs of 10 or as a complete range in a wall display unit.

**Code**    **Model**    **Length**    **Ø**    **Ø**  
1680 006            80 cm    4,6 mm    2,20 - 4,60 mm  
1680 007            80 cm    5,0 mm    2,20 - 4,90 mm  
1680 008            100 cm    5,3 mm    2,40 - 5,30 mm  
1680 009            110 cm    6,0 mm    2,80 - 5,60 mm  
1680 005    Set



**Feeder Tip Bag**

Practical storage bag for spare quivertips. Finished in hard material for optimal protection of delicate tips. With zip fastener. Material: 100% Nylon

**Code**    **Length**  
8518 026    80 cm  
Trade Pack 5 Pieces



**Xitan Pole Cleaning Brush Set**

A set of 3 brushes on long stiff wires that can be use to keep the inside of pole sections clean. 3 sizes of brush included for different section diameters.

**Code**  
6625 999  
Trade Pack 5 Pieces





## Groundbait No. 1

The most versatile groundbait in the Champions Choice line. No. 1 can be used as a base mix with all of our other groundbaits. It is suited for very dry use as an explosive feeder mix or watered down for use on lakes and rivers. This mix has been used successfully for years by the Browning Team, which is a testament to its quality. The dark colour comes solely from the use of natural flours. The slightly bitter aroma of this groundbait holds fish in the swim for long periods. Grain size: medium – fine.

**Code Contents**  
3970 001 1 kg

Supplied as: 6 x 1 kg bags  
Trade Pack 6 Pieces



## Groundbait Grand Slam

Brown groundbait for enticing shoals of bream. A sweet groundbait which is both intensively attractive and highly adhesive, making it perfectly suited to mixing with large volumes of bait and/or particles. Grand Slam is particularly successful when used in conjunction with chopped worms and casters. Even large specimen bream are held in the swim for long periods. Grain size: large. Adhesion: strong.

**Code Contents**  
3970 015 1 kg

Supplied as: 6 x 1 kg bags  
Trade Pack 6 Pieces



## Groundbait M7

Legendary Dutch feeder groundbait for use on lakes and rivers. For stillwaters, M7 is soaked an hour before fishing and passed through a medium sized sieve to retain its explosiveness. For rivers, M7 should be soaked the evening before fishing to ensure that it sinks properly without floating particles being carried away. Moisten again slightly before fishing and pass through a medium sized sieve. With M7, even the smallest quantities of groundbait can hold large groups of fish in the swim for long periods. The groundbait is very filling and has a sweet scent and flavour. Grain size: large.

**Code Contents**  
3970 002 1 kg

Supplied as: 6 x 1 kg bags  
Trade Pack 6 Pieces



## Groundbait River

A match fishing groundbait with very strong binding properties and long lasting effect, suitable for large whiting. River is perfect for use on large flowing rivers with plenty of boat traffic. This groundbait can be combined with large quantities of particles to keep fish searching throughout your match. Its unique blend of aromas attracts fish quickly and over long distances. Grain size: medium

**Code Contents**  
3970 003 1 kg

Supplied as: 6 x 1 kg bags  
Trade Pack 6 Pieces



## Groundbait Etang

This groundbait is perfectly suited for attracting large fish in lakes and slow running waters. The high percentage of ground hemp seeds and use of high quality flavourings attracts fish over long distances. The addition water allows for maggots, casters or bloodworms to be added. Grain size: fine

**Code Contents**  
3970 004 1 kg

Supplied as: 6 x 1 kg bags  
Trade Pack 6 Pieces



## Groundbait Canal

Canal has a distinctly aromatic scent which is irresistible to large roach, bream and silver bream. The groundbait is made from the finest toasted breadcrumbs with roasted flavour and ground hemp. Canal is perfect for use with bloodworm as there are no salty ingredients to damage the bait. This brown coloured groundbait is well suited to all types of running water.

**Code Contents**  
3970 005 1 kg

Supplied as: 6 x 1 kg bags  
Trade Pack 6 Pieces



Improved formula!

## Groundbait Big Fish

A heavy, bright yellow groundbait for large fish such as bream, tench and carp. The strong binding properties and long lasting effect ensures that large volumes of particles such as casters, worms and gravel can be mixed with the bait. The sweet scent of almond, vanilla and marzipan is irresistible to huge specimens. Big Fish is suitable for use on large rivers and lakes. Grain size: large.

**Code Contents**  
3970 006 1 kg

Supplied as: 6 x 1 kg bags  
Trade Pack 6 Pieces



## Groundbait Black Magic®

Groundbait for the most difficult conditions! The very dark, almost black colour makes this groundbait perfect for fishing in clear water. The special colouration makes Black Magic® perfectly suited to the lake or river bed, leading the fish straight to the feeding site and keeping them there. Black Magic® has highly active ingredients which roach especially find irresistible. The selected combination of attractors makes the scent and flavour attractive to all types of silver fish. Grain size: medium.

**Code Contents**  
3970 007 1 kg

Supplied as: 6 x 1 kg bags  
Trade Pack 6 Pieces





## Groundbait Gardons

Specifically developed for targeting larger roach on canals and rivers, Gardons has just the right properties to attract and hold specimen fish in your swim and to keep them feeding. With few active ingredients the fish will concentrate directly on the feeding area. The distinctive aroma of ground spices is irresistible to large roach and bream. Grain size: large. Adhesion: medium.

**Code Contents**  
3970 011 1 kg

Supplied as: 6 x 1 kg bags  
Trade Pack 6 Pieces



## Groundbait Red Roach

A roach groundbait without an equal. The rich red colour of the groundbait provides an unbeatable advantage on coloured waters and in spring. Only the best high quality ingredients are used for Red Roach. The distinctive scent of roasted hemp combined with a special mixture of additives is irresistible to large roach and skimmer bream. Red Roach can be used on slow flowing canals and stillwaters and is perfect for use with bloodworm. Grain size: medium. Adhesion: medium.

**Code Contents**  
3970 012 1 kg

Supplied as: 6 x 1 kg bags  
Trade Pack 6 Pieces



## Groundbait Tench

This unique Tench mixture from the 'Champions Choice' groundbait range, has been specially designed to attract tench, but also holds a magical appeal for huge bream and carp. The binding strength has been formulated to maximise catch rate in lakes and slow flowing rivers. The groundbait receives its dark colouration from the finest fish meal. The fishy aroma with a subtle hint of sweet biscuit attracts large specimens quickly and holds them in the swim for long periods. During test development, our angling consultant managed to land monster tench over 9.5 lb as well as double figure bream. Grain size: medium, Binding strength: medium.

**Code Contents**  
3970 020 1 kg

Supplied as: 6 x 1 kg bags  
Trade Pack 6 Pieces



## Groundbait All Seasons

An excellent, versatile groundbait in the Champions-Choice bait range. The intensive aroma of this combination of spices particularly draws roach, bream and silver bream to the swim. The slightly dark colour comes solely from the use of natural feed and spices. These ingredients achieve a successful balance between the needs of winter angling, when the fish are somewhat choosy, and fishing at warmer times of year when they are filling their hungry mouths. A true all-round blend for all types of water. Grain size: medium-fine

**Code Contents**  
3970 064 1 kg

Supplied as: 6 x 1 kg bags  
Trade Pack 6 Pieces



## Groundbait Easy Cheesy

Developed for barbel fishing on large rivers, the distinctive parmesan cheese scent is irresistible to barbel. Easy Cheesy contains large red food particles which are slowly released from the balls of groundbait into the current, attracting fish from large distances. The strong binding properties of the groundbait provide a long lasting effect, holding fish in the feeding area. The groundbait can also carry large quantities of live bait and particles. Grain size: large. Adhesion: very strong.

**Code Contents**  
3970 013 1 kg

Supplied as: 6 x 1 kg bags  
Trade Pack 6 Pieces



## Groundbait Sweet Breams

A light-coloured groundbait for attracting shoals of specimen bream. Sweet Breams has a unique almond scent which bream simply cannot resist. Principally for use in the summer months the groundbait has good binding properties making it perfectly suited to attracting and holding large shoals on lakes and large rivers. Grain size: large. Adhesion: strong.

**Code Contents**  
3970 014 1 kg

Supplied as: 6 x 1 kg bags  
Trade Pack 6 Pieces



## Groundbait Crispy Carp

When it comes to selectively attracting big fish such as carp and bream, and then holding them in the swim for long periods, a very coarse groundbait with plenty of particles is ideal. Crispy Carp binds well and therefore allows large amounts of additional loose feed to be included in the mix. With its light colour and intensive fruity aroma, the groundbait is perfect when large numbers of big fish are expected. As is traditional from Browning, we only use the highest quality ingredients for our Crispy Carp. The special feature is the cornflakes which give the groundbait an unmistakable appearance.

**Code Contents**  
3970 040 1 kg

Supplied as: 6 x 1 kg bags  
Trade Pack 6 Pieces







### BBQ Black Halibut Method Mix

A dark feed with a strikingly natural smell of fish. This comes from the feed's high content of finely ground fish meal, enhanced with an extra portion of fish oil. It attracts carp to your swim magically. Just add water, press into the Method feeder cage and start fishing!

Code	Colour	Contents	Flavour
3970 076	dark brown	1 kg	Black Halibut

Supplied as: 6 x 1 kg bags  
Trade Pack 6 Pieces



### BBQ Red Krill Method Mix

Thanks to high-quality krill, this feed takes on a striking red colour, which alone attracts the fish to your swim. In testing, Red Krill convinced us by its quick attraction!

Code	Colour	Contents	Flavour
3970 077	red	1 kg	Red Krill

Supplied as: 6 x 1 kg bags  
Trade Pack 6 Pieces



### BBQ Sweet Magnum Method Mix

Sweet, yellow, corn! That is the right formula for an exceptional feed. Thanks to its special meals, it separates easily from the Method feeder cage and creates a nice and highly attractive cloud. Ideal for large silver fish and carp!

Code	Colour	Contents	Flavour
3970 078	yellow	1 kg	Sweet Magnum

Supplied as: 6 x 1 kg bags  
Trade Pack 6 Pieces



### BBQ Green Mussel Method Mix

If a feed is enriched with a generous portion of mussel meal and fish meal, it is certain to catch you fish! It separates easily from the feeder cage, creates a nice cloud in the swim and attracts carp even from a large distance. Just add water, mix, and start catching!

Code	Colour	Contents	Flavour
3970 079	green	1 kg	Green Mussel

Supplied as: 6 x 1 kg bags  
Trade Pack 6 Pieces



### Groundbait Black Monster

A coarse, black groundbait with a hint of vanilla. Ideal on flowing waters when the big fish are being cautious and will not entertain a bright feeding ground. In extraordinary situations, this groundbait yields the special fish.

Code	Contents
3970 070	1 kg

Supplied as: 6 x 1 kg bags  
Trade Pack 6 Pieces



### Groundbait Spicy Thunder

A dark groundbait with a strong spicy vanilla note which, combined with the ground hemp, drives the fish crazy. The dark brown colour ensures that even cautious fish are not spooked. Suitable for light flowing water or canals and yields fish when all other groundbait varieties fail.

Code	Contents
3970 071	1 kg

Supplied as: 6 x 1 kg bags  
Trade Pack 6 Pieces



### Groundbait Wild Black River

Dark groundbait with a quite special aroma thanks to the use of Copra Melasse and PV 1. When the groundbait is wet, the colourful particles give it a quite unique appearance creating an unmissable feed carpet for the fish. This ensures the fish remain in the swim even after several hours. With no additional aromas, allowing the angler to add his own favourite scents to the groundbait.

Code	Contents
3970 072	1 kg

Supplied as: 6 x 1 kg bags  
Trade Pack 6 Pieces



### Groundbait Boombastic Bream

Sweet, yellow and extremely attractive! An ideal groundbait when bream, silver bream and orfe are on the menu and you want your keepnet filled to bursting. The pleasant aroma is created by the flours used, without the use of any additives. This leaves the angler free to add his own favourite scents. The use of sweet biscuit makes the groundbait particularly suited to flowing water.

Code	Contents
3970 073	1 kg

Supplied as: 6 x 1 kg bags  
Trade Pack 6 Pieces





### Groundbait Stillwater Surprise

A groundbait with an extraordinary consistency, fantastic yellow colour and an abundance of particles. Releases particularly quickly from the feeder to create a highly attractive carpet, keeping larger numbers of fish in the swim for long periods. With no additives, allowing the angler to give free reign to his imagination.

Code	Contents
3970 074	1 kg

Supplied as: 6 x 1 kg bags  
Trade Pack 6 Pieces



### Groundbait Mad Roach

A black groundbait, particularly suited to catching roach on stillwaters. Are the fish being cautious and refusing to stay in a bright feeding ground? These are the situations in which our Mad Roach comes into its own. The light lacto aroma gives the groundbait a sweet note while the ground hemp acts like a magnet for roach.

Code	Contents
3970 075	1 kg

Supplied as: 6 x 1 kg bags  
Trade Pack 6 Pieces



### BBQ Extreme Halibut Method Mix

A highly concentrated powder comprising ground halibut pellets to give your groundbait an additional kick of aromas and protein. Simply add one to two spoonfuls to 1 kg of groundbait and you're done. Attracts fish to your swim when all else fails.

Code	Colour	Contents	Flavour
3803 001	black	300 g	Halibut

Trade Pack 6 Pieces



### BBQ Extreme Krill Method Mix

A highly concentrated powder comprising ground krill pellets to give your groundbait an additional kick of aromas and protein. Simply add one to two spoonfuls to 1 kg of groundbait and you're done. Also suitable for giving an added boost to sweet groundbait.

Code	Colour	Contents	Flavour
3803 002	red	300 g	Krill

Trade Pack 6 Pieces



### Groundbait Display, Browning

Easy to assemble shop display made from robust, printed cardboard for up to 8 bags of groundbait from the attractive Browning range. Improves sales enormously. Groundbait not included.

Code	9963 010
------	----------



### Krazy Sweetener

'Krazy Sweetener' is the ideal solution for sweetening groundbait. Carp, bream, tench and other silver fish love a sweet flavour. Krazy Sweetener is many times sweeter than ordinary sugar and is made from sodium-saccharin (around 300 times sweeter than sugar), NHDC (around 1,500 times sweeter) and purely natural, intensively sweetening plant extracts. In contrast with other sweeteners Krazy Sweetener lacks the customary bitter after taste. Recommended dosage: 1 teaspoon per approx. 1-3 liters of groundbait.

Code	Contents
3935 015	400 ml

Trade Pack 6 Pieces



### Krazy Glue

'Krazy Glue' is perfect for forming handfuls of maggots into small balls. Simply remove any sawdust from the maggots and to achieve maximum results preferably clean with Browning Champions Choice 'Krazy Clean'. Then add a little water but do not get the maggots too wet. Then sprinkle Krazy Glue over the top. Slowly mould the maggots together to form the desired ball size. You may want to add in some grit previously to make the balls heavier. Once completed the balls will break up quickly in the water.

Code	Contents
3935 010	400 ml

Trade Pack 6 Pieces



### BBQ Extreme GLM Method Mix

A highly concentrated powder comprising ground mussels to give your groundbait an additional kick of aromas and protein. Simply add one or two spoonfuls to 1 kg of groundbait and you're done. If bites start to tail off after a while, this powder will turn a session around!

Code	Colour	Contents	Flavour
3803 003	green	300 g	Green Lip Mussel

Trade Pack 6 Pieces



### BBQ Extreme Sweet Corn Method Mix

The maize extract makes this powder simply beyond compare. Simply add one to two spoonfuls to 1 kg of groundbait and you're ready. Attracts all kinds of fish magically to your feeding ground.

Code	Colour	Contents	Flavour
3803 004	yellow	300 g	Sweet Corn

Trade Pack 6 Pieces





Bitter almond      Toffee Caramel      Spicy Gardon      Super Vanilla



Strawberry      Brasem Orange      Lacto      Sweet Appetizer

## Champion's Choice Power Additive

Attractors in powder form have become indispensable for match angling. These allow groundbait to be quickly adapted to changing water conditions. A new scent on the scene can send fish with closed mouths back into a feeding frenzy. The CC Power Additive range is the result of years of experience of our test anglers, who have worked meticulously on the recipes. Take advantage of their experience and bumper catches are guaranteed.

Contents	Bitter almond	Toffee Caramel	Spicy Gardon	Super Vanilla	Strawberry	Brasem Orange	Lacto	Sweet Appetizer
250 g	3927 001	3927 002	3927 003	3927 004	3927 005	3927 006	3927 007	3927 008

Trade Pack 6 Pieces



Liver Extreme / brown      Bubble Gum / orange      Sweet Vanilla / clear      Marzipan / yellow/brown



Cheese/Kingcrab / red      Monster Mussel / green



## Match & Feeder Dip

A new range of dips with attractive aromas. Relatively thin, as per the current trend, to enable rapid wetting and quick release of the active ingredients under water.

Contents	Liver Extreme brown	Bubble Gum orange	Sweet Vanilla clear	Marzipan yellow/brown	Cheese/Kingcrab red	Monster Mussel green
30 ml	3900 001	3900 002	3900 003	3900 004	3900 005	3900 006

Trade Pack 6 Pieces



Chicken Liver      Pineapple      Bubble Gum



Green Mussel      Monster Crab      Garlic

## Soft Hook Pellets

Our Soft Pellets are perfectly suited for use as hook baits for any kind of silver fish and carp. Highest catch rate and very easy to use!

Ø	Contents	Chicken Liver	Pineapple	Bubble Gum	Green Mussel	Monster Crab	Garlic
6 mm	80 g	3903 001	3903 002	3903 003	3903 004	3903 005	3903 006
8 mm	80 g	3903 101	3903 102	3903 103	3903 104	3903 105	3903 106

Trade Pack 6 Pieces



Cheese      Spicy      Mussel      Strawberry

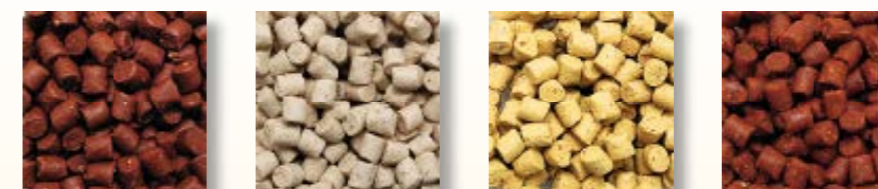

Halibut      White Chocolate      Cream Vanilla      Monster Crab



## Hybrid Chewies

Soft Pellets have proven to be a real „killer“ bait, and not only for carp as bream, tench and even big roach have developed a real taste for them. Hybrid Chewies are 8 mm in size and come in eight flavour- colour combinations and have been thoroughly tested to be just the right texture and firmness for the hooking or hair rigging. Packed in re-sealable, space saving and stackable boxes of 100g – perfect when the angler wants to have a selection of different baits handy.

Ø	Contents	Cheese	Spicy	Mussel	Strawberry	Halibut	White Chocolate	Cream Vanilla	Monster Crab
8 mm	100 g	3974 001	3974 002	3974 003	3974 004	3974 005	3974 006	3974 007	3974 008

Trade Pack 10 Pieces





Bitter almond      Garlic      Super Vanilla



Bloody Liver      Monster Crab      Halibut

### Marble Dust

Flavours in a spray bottle. Ideal for giving mini-boilies that extra attraction particularly with our unflavoured Neon Pop Up Marbles. In 6 tried, trusted and very popular flavours.

Contents	Bitter almond	Garlic	Super Vanilla	Bloody Liver	Monster Crab	Halibut
100 ml	3928 025	3928 026	3928 027	3928 028	3928 029	3928 030

Trade Pack 10 Pieces



Chicken Liver / brown      Pineapple / yellow      Bubble Gum / orange



Mussel / green      Monster Crab / red      Garlic / white/nature

### Mini Pop-up Boilie, pre-drilled

Mini-Pop-Up-Boilies, perfect for method angling. Large bream, barbel and tench simply cannot resist them. Also pre-drilled!

Ø	Contents	Action	Chicken Liver brown	Pineapple yellow	Bubble Gum orange	Mussel green	Monster Crab red	Garlic white/nature
8 mm	30 g	floating	3902 101	3902 102	3902 103	3902 104	3902 105	3902 106
10 mm	30 g	floating	3902 201	3902 202	3902 203	3902 204	3902 205	3902 206

Trade Pack 6 Pieces



Chicken Liver / brown      Pineapple / yellow      Bubble Gum / orange



Mussel / green      Monster Crab / red      Garlic / white/nature

### Mini Boilie, pre-drilled

Mini-boilies have become indispensable in modern coarse fishing. A must when fishing "the method", whether for carp, tench, bream or barbel. The new Browning Mini Boilies are available in two diameters (8 and 10 mm) and are conveniently pre-drilled.

Ø	Contents	Action	Chicken Liver brown	Pineapple yellow	Bubble Gum orange	Mussel green	Monster Crab red	Garlic white/nature
8 mm	60 g	sinking	3901 101	3901 102	3901 103	3901 104	3901 105	3901 106
10 mm	60 g	sinking	3901 201	3901 202	3901 203	3901 204	3901 205	3901 206

Trade Pack 6 Pieces



Chicken Liver / brown      Pineapple / yellow      Bubble Gum / orange



Mussel / green      Monster Crab / red      Garlic / white

### Mini Boilie Neon, pre-drilled

When bright colours are needed for Method fishing, our pre-drilled Neon Minis really come into their own. The six selected flavour and colour combinations make even cautious fish curious and tempted to bite.

Ø	Contents	Chicken Liver brown	Pineapple yellow	Bubble Gum orange	Mussel green	Monster Crab red	Garlic white
10 mm	60 g	3905 001	3905 002	3905 003	3905 004	3905 005	3905 006

Trade Pack 6 Pieces





Natural / natural

Sweet Vanilla / yellow

Chili / red

Garlic / natural

## Hemp Seed

Every angler knows the magical attraction of hemp to a variety of silver fish species. Whether as an addition to groundbait or as a hookbait, hemp is simply unbeatable. Our flavoured varieties contain a high-quality combination of flavours, doubling their powers of temptation. In a resealable tub for optimal storage.

Contents	Natural	Sweet Vanilla	Chili	Garlic
	natural	yellow	red	natural
300 g	3800 001	3800 002	3800 003	3800 004

Trade Pack 6 Pieces



## Silicone Bait Holder

Practical fastener with a silicone tab for holding the hook and a pre-attached boilie needle.

Code	Content
6608 003	5 pcs

Trade Pack 10 Pieces



## Band Aid Forceps

No more fumbling around trying to push pellets onto pellet bands. Take the strain away from this task fishing is more fun this way. Incl. 10 of each size S, M, L super stretch pellet band.

Code

6325 010

Trade Pack 5 Pieces



## Boilie Pin

Small metal needle for baiting mini boilies on the hair. For a bait that sticks like glue. The fastest way to bait.

Code	Content
6602 010	20 pcs

Trade Pack 10 Pieces

## Bait Bands

100% pure latex, natural coloured, thin walled and high stretch pellet bands in the 3 popular most popular sizes.

Code	Ø	Content
3968 010	4 mm	30 pcs
3968 011	7 mm	30 pcs
3968 012	10 mm	30 pcs

Trade Pack 10 Pieces



## Black Magic® Gold Mono

Black Magic quality, multi-purpose monofilament line on convenient bulk spools. A good value reliable line that is suitable for every style of fishing, float or feeder.

Code	Ø	Length	BS	Colour
2220 017	0,17 mm	680 m	2,05 kg / 4,50 lbs	dark brown
2220 019	0,19 mm	680 m	3,00 kg / 6,60 lbs	dark brown
2220 021	0,21 mm	640 m	3,65 kg / 8,00 lbs	dark brown
2220 023	0,23 mm	610 m	4,35 kg / 9,60 lbs	dark brown
2220 027	0,27 mm	490 m	5,70 kg / 12,60 lbs	dark brown

Trade Pack 10 Pieces



## Black Magic® Gold Braid

Black Magic quality, multi-strand braided line for feeder fishing. Excellent value, reliable and very long lasting. Aids casting and greatly improves bite detection.

Code	Ø	Length	BS	Colour
2337 008	0,08 mm	150 m	3,3 kg / 7,5 lbs	black
2337 010	0,10 mm	150 m	3,6 kg / 8 lbs	black
2337 012	0,12 mm	150 m	4,5 kg / 10 lbs	black

Trade Pack 5 Pieces



## Cenex Feeder Gum

High quality shock absorbing gum. Versatile and kind to line.

Code	Ø	Length
6235 108	0,80 mm	10 m

Trade Pack 5 Pieces



## Pellet Pump

Gone are the days when it took an eternity for pellets to be ready for use. With the Browning Pellet Pump, it takes literally seconds for floating, hard pellets to be saturated with water and become soft and pliable. Simply put pellets and water in the container, close the lid and expel the air from the container with the pump plunger. Then press the valve on the lid and allow the air back in, the pellets are now ready and the lid can be removed. An indispensable tool for all coarse anglers.

Code	Contents
8062 001	0,50 l

Trade Pack 6 Pieces





### Cenex Low Stretch Mono

A specialist pre-stretched reel line for feeder fishing. The ultra-low stretch formulation of this line boosts bite detection when fishing at distance so is an easier-to-use alternative to braided lines. Abrasion resistant with a smooth surface finish.

Code	Ø	Length	BS	Colour
2231 014	0,14 mm	150 m	2,10 kg / 4,60 lbs	black
2231 016	0,16 mm	150 m	2,65 kg / 5,80 lbs	black
2231 018	0,18 mm	150 m	3,15 kg / 6,90 lbs	black
2231 020	0,20 mm	150 m	3,85 kg / 8,50 lbs	black
2231 022	0,22 mm	150 m	4,85 kg / 10,70 lbs	black
2231 024	0,24 mm	150 m	6,10 kg / 13,40 lbs	black
2231 026	0,26 mm	150 m	7,15 kg / 15,70 lbs	black

Trade Pack 10 Pieces



### Cenex Classic Mono

Our well proven and popular Cenex line is ultra supple and provides perfect bait presentation guaranteed to help catch more fish. However, it's also recognised as one on the strongest fine diameter lines available. The choice of serious competition anglers.

Code	Ø	Length	BS	Colour
2238 006	0,06 mm	50 m	0,45 kg / 1,00 lbs	brown
2238 007	0,07 mm	50 m	0,55 kg / 1,20 lbs	brown
2238 008	0,08 mm	50 m	0,75 kg / 1,60 lbs	brown
2238 010	0,10 mm	100 m	1,00 kg / 2,20 lbs	brown
2238 012	0,12 mm	100 m	1,55 kg / 3,40 lbs	brown
2238 014	0,14 mm	100 m	2,05 kg / 4,50 lbs	brown
2238 016	0,16 mm	100 m	2,60 kg / 5,70 lbs	brown

Trade Pack 10 Pieces



### Cenex Feeder Braid, Sinking

Round profile, zero stretch, braided line for feeder fishing. Incorporates a Teflon strand which makes the braid exceptionally fast and easy to sink in all conditions.

Code	Ø	Length	BS	Colour
2225 008	0,08 mm	150 m	4,55 kg / 10,00 lbs	grey/green
2225 010	0,10 mm	150 m	5,45 kg / 12,00 lbs	grey/green
2225 012	0,12 mm	150 m	6,80 kg / 15,00 lbs	grey/green

Trade Pack 10 Pieces



### Cenex Method Mono

Camou-coloured line (three colours) with high durability. Ideal for method feeder fishing, whether in competition or when specimen hunting. In fact, whenever you need a reliable, inconspicuous line. Very fast sinking like a plummet!

Code	Ø	Length	BS	Colour
2241 020	0,20 mm	150 m	3,65 kg / 8,10 lbs	camou
2241 022	0,22 mm	150 m	4,70 kg / 10,40 lbs	camou
2241 024	0,24 mm	150 m	5,80 kg / 12,80 lbs	camou
2241 026	0,26 mm	150 m	6,80 kg / 15,00 lbs	camou

Trade Pack 10 Pieces



### Cenex Hybrid Power Mono

Primarily designed for hook-lengths and pole rigs, This superb high-tech and high-quality co-polymer line specially formulated for demanding big-fish situations. The line offers brilliant abrasion resistance, knot strength and breaking strains but is remarkably supple to allow perfect bait presentation. Superstrong, supertough and supersupple.

Code	Ø	Length	BS	Colour
2240 012	0,12 mm	100 m	1,70 kg / 3,70 lbs	transparent
2240 014	0,14 mm	100 m	2,55 kg / 5,60 lbs	transparent
2240 016	0,16 mm	100 m	3,00 kg / 6,60 lbs	transparent
2240 018	0,18 mm	100 m	3,90 kg / 8,50 lbs	transparent
2240 020	0,20 mm	100 m	4,20 kg / 9,20 lbs	transparent

Trade Pack 10 Pieces



### Cenex Feeder Mono

A quality reel line with a special smooth surface seal which increases casting distance, improves retrieve and makes the line highly abrasion resistant. This medium-stretch sinking line is very supple so it is also very good choice for float fishing, particularly at medium to long distance.

Code	Ø	Length	BS	Colour
2226 014	0,14 mm	150 m	1,80 kg / 4,00 lbs	black
2226 016	0,16 mm	150 m	2,25 kg / 5,00 lbs	black
2226 018	0,18 mm	150 m	2,70 kg / 6,00 lbs	black
2226 020	0,20 mm	150 m	3,35 kg / 7,40 lbs	black
2226 022	0,22 mm	150 m	4,40 kg / 9,70 lbs	black
2226 024	0,24 mm	150 m	5,35 kg / 11,80 lbs	black
2226 026	0,26 mm	150 m	5,80 kg / 12,80 lbs	black
2226 028	0,28 mm	150 m	6,20 kg / 13,70 lbs	black

Trade Pack 10 Pieces



### Cenex Fluoro Carbon Hook Line

Top quality Fluorocarbon line for hooklengths / leaders as it is invisible in water! Carefully formulated to be supple and deliver a high breaking strain and knot strength.

Code	Ø	Length	BS	Colour
2230 011	0,11 mm	50 m	1,25 kg / 2,70 lbs	transparent
2230 013	0,13 mm	50 m	1,60 kg / 3,50 lbs	transparent
2230 015	0,15 mm	50 m	2,10 kg / 4,60 lbs	transparent
2230 017	0,17 mm	50 m	2,95 kg / 6,50 lbs	transparent

Trade Pack 10 Pieces





### Feeder Big Fish hook-to-nylon

All-round feeder hooklengths with robust Mustad hooks and trusted Cenex monofilament. Ideal for bream and other feisty coarse fish. Hook: Mustad 60345NP-BR.

Code	Ø	Hook Size	Hooklength	BS	Content	Colour
4705 008	0,22 mm	8	60 cm	10 lbs / 4,5 kg	8 pcs	bronze
4705 010	0,22 mm	10	60 cm	7,5 lbs / 3,5 kg	8 pcs	bronze
4705 012	0,20 mm	12	60 cm	6 lbs / 2,8 kg	8 pcs	bronze
4705 014	0,18 mm	14	60 cm	5 lbs / 2,3 kg	8 pcs	bronze
4705 016	0,16 mm	16	60 cm	4 lbs / 1,9 kg	8 pcs	bronze
4705 108	0,22 mm	8	100 cm	10 lbs / 4,5 kg	8 pcs	bronze
4705 110	0,22 mm	10	100 cm	7,5 lbs / 3,5 kg	8 pcs	bronze
4705 112	0,20 mm	12	100 cm	6 lbs / 2,8 kg	8 pcs	bronze
4705 114	0,18 mm	14	100 cm	5 lbs / 2,3 kg	8 pcs	bronze
4705 116	0,16 mm	16	100 cm	4 lbs / 1,9 kg	8 pcs	bronze

Trade Pack 10 Pieces



### Feeder Master hook-to-nylon

Versatile feeder hooklengths with ultra-sharp Mustad hooks and trusted Cenex monofilament. Hook: Mustad 60332NP-BR.

Code	Ø	Hook Size	Hooklength	BS	Content	Colour
4709 010	0,16 mm	10	60 cm	5 lbs / 2,3 kg	8 pcs	bronze
4709 012	0,14 mm	12	60 cm	4 lbs / 1,9 kg	8 pcs	bronze
4709 014	0,14 mm	14	60 cm	4 lbs / 1,9 kg	8 pcs	bronze
4709 016	0,14 mm	16	60 cm	3 lbs / 1,5 kg	8 pcs	bronze
4709 018	0,12 mm	18	60 cm	3 lbs / 1,5 kg	8 pcs	bronze
4709 020	0,12 mm	20	60 cm	2 lbs / 1 kg	8 pcs	bronze
4709 110	0,16 mm	10	100 cm	5 lbs / 2,3 kg	8 pcs	bronze
4709 112	0,14 mm	12	100 cm	4 lbs / 1,9 kg	8 pcs	bronze
4709 114	0,14 mm	14	100 cm	4 lbs / 1,9 kg	8 pcs	bronze
4709 116	0,14 mm	16	100 cm	3 lbs / 1,5 kg	8 pcs	bronze
4709 118	0,12 mm	18	100 cm	3 lbs / 1,5 kg	8 pcs	bronze
4709 120	0,12 mm	20	100 cm	2 lbs / 1 kg	8 pcs	bronze

Trade Pack 10 Pieces



### Feeder Method hook-to-nylon with pellet band

Short method hooklengths in Cenex monofilament. The robust Mustad hook will even stand up to carp during a fight. With pellet band on the hair. Hook: Mustad 60342NP-BR.

Code	Ø	Hook Size	Hooklength	BS	Content	Colour
4706 010	0,22 mm	10	10 cm	10 lbs / 4,5 kg	8 pcs	bronze
4706 012	0,20 mm	12	10 cm	7,5 lbs / 3,5 kg	8 pcs	bronze
4706 014	0,18 mm	14	10 cm	6 lbs / 2,8 kg	8 pcs	bronze
4706 016	0,18 mm	16	10 cm	6 lbs / 2,8 kg	8 pcs	bronze
4706 018	0,16 mm	18	10 cm	5 lbs / 2,3 kg	8 pcs	bronze

Trade Pack 10 Pieces



### Feeder Method hook-to-nylon with boilie needle

Short method hooklengths in Cenex monofilament. The robust Mustad hook will even stand up to carp during a fight. With boilie needle on the hair. Hook: Mustad 60342NP-BR.

Code	Ø	Hook Size	Hooklength	BS	Content	Colour
4706 110	0,22 mm	10	10 cm	10 lbs / 4,5 kg	8 pcs	bronze
4706 112	0,20 mm	12	10 cm	7,5 lbs / 3,5 kg	8 pcs	bronze
4706 114	0,18 mm	14	10 cm	6 lbs / 2,8 kg	8 pcs	bronze
4706 116	0,18 mm	16	10 cm	6 lbs / 2,8 kg	8 pcs	bronze
4706 118	0,16 mm	18	10 cm	5 lbs / 2,3 kg	8 pcs	bronze

Trade Pack 10 Pieces



### Feeder Sensitive hook-to-nylon

Light feeder hooks from Mustad on trusted Cenex monofilament. Can even be used with pinkies or bloodworm when the fish are being finicky. Hook: Mustad 60005NP-RB.

Code	Ø	Hook Size	Hooklength	BS	Content	Colour
4710 014	0,14 mm	14	60 cm	4 lbs / 1,9 kg	8 pcs	red
4710 016	0,12 mm	16	60 cm	3 lbs / 1,5 kg	8 pcs	red
4710 018	0,12 mm	18	60 cm	2 lbs / 1 kg	8 pcs	red
4710 020	0,12 mm	20	60 cm	2 lbs / 1 kg	8 pcs	red
4710 022	0,10 mm	22	60 cm	2 lbs / 1 kg	8 pcs	red
4710 114	0,14 mm	14	100 cm	4 lbs / 1,9 kg	8 pcs	red
4710 116	0,12 mm	16	100 cm	3 lbs / 1,5 kg	8 pcs	red
4710 118	0,12 mm	18	100 cm	2 lbs / 1 kg	8 pcs	red
4710 120	0,12 mm	20	100 cm	2 lbs / 1 kg	8 pcs	red
4710 122	0,10 mm	22	100 cm	2 lbs / 1 kg	8 pcs	red

Trade Pack 10 Pieces



### Feeder Trophy Fish hook-to-nylon

When you have to go large while feeder fishing, this Mustad hook with attached maggot clip is always the first choice. Hook: Mustad 60346NP-BR.

Code	Ø	Hook Size	Hooklength	BS	Content	Colour
4711 010	0,25 mm	10	75 cm	12 lbs / 5,6 kg	6 pcs	bronze
4711 012	0,22 mm	12	75 cm	12 lbs / 5,6 kg	6 pcs	bronze
4711 014	0,22 mm	14	75 cm	12 lbs / 5,6 kg	6 pcs	bronze

Trade Pack 10 Pieces



### Feeder Leader Method Push Stop

Short method hooklengths in Cenex monofilament. With push stop on the hair for simple bait attachment. Barbless. Includes push-stop needle.

Code	Ø	Hook Size	Hooklength	BS	Content	Colour
4704 012	0,22 mm	12	10 cm	10 lbs / 4,5 kg	8 pcs	bronze
4704 014	0,22 mm	14	10 cm	10 lbs / 4,5 kg	8 pcs	bronze
4704 016	0,22 mm	16	10 cm	10 lbs / 4,5 kg	8 pcs	bronze
4704 018	0,22 mm	18	10 cm	10 lbs / 4,5 kg	8 pcs	bronze

Trade Pack 10 Pieces



### Feeder Leader Method Push Stop

Short method hooklengths in Cenex monofilament. With push stop on the hair for simple bait attachment. Barbed. Includes push-stop needle.

Code	Ø	Hook Size	Hooklength	BS	Content	Colour
4707 010	0,22 mm	10	10 cm	10 lbs / 4,5 kg	6 pcs	bronze
4707 012	0,20 mm	12	10 cm	7,5 lbs / 3,40 kg	6 pcs	bronze
4707 014	0,18 mm	14	10 cm	6 lbs / 3,0 kg	6 pcs	bronze
4707 016	0,18 mm	16	10 cm	6 lbs / 3,0 kg	6 pcs	bronze
4707 018	0,16 mm	18	10 cm	5 lbs / 2,30 kg	6 pcs	bronze

Trade Pack 10 Pieces





### Feeder Leader Method Power Pellet Band

Short method hooklengths in Cenex monofilament. With pellet band on the hair for simple bait attachment and particularly robust Mustad hook.

Code	Ø	Hook Size	Hooklength	BS	Content	Colour
4708 010	0,25 mm	10	10 cm	12 lbs / 5,00 kg	6 pcs	bronze
4708 012	0,22 mm	12	10 cm	10 lbs / 4,5 kg	6 pcs	bronze
4708 014	0,22 mm	14	10 cm	10 lbs / 4,5 kg	6 pcs	bronze
4708 016	0,20 mm	16	10 cm	7,5 lbs / 3,40 kg	6 pcs	bronze

Trade Pack 10 Pieces



### Feeder Leader Sensitive FC

Light feeder hooks from Mustad on invisible fluorocarbon monofilament. Can even be used with pinkies or bloodworm when the fish are being finicky. Hooks: Mustad 60005NP-RB.

Code	Ø	Hook Size	Hooklength	BS	Content	Colour
4710 216	0,12 mm	16	60 cm	1,10 kg / 2,5 lbs	5 pcs	red
4710 218	0,12 mm	18	60 cm	1,10 kg / 2,5 lbs	5 pcs	red
4710 220	0,12 mm	20	60 cm	1,10 kg / 2,5 lbs	5 pcs	red

Trade Pack 10 Pieces



### Feeder Leader Waggle/Feeder Pellet Band

All-round hooklengths in Cenex monofilament. With pellet band on the hair for simple bait attachment. Ideal for feeder and float fishing. Barbless.

Code	Ø	Hook Size	Hooklength	BS	Content	Colour
4713 012	0,18 mm	12	30 cm	6,5 lbs / 3,00 kg	8 pcs	bronze
4713 014	0,18 mm	14	30 cm	6,5 lbs / 3,00 kg	8 pcs	bronze
4713 016	0,18 mm	16	30 cm	6,5 lbs / 3,00 kg	8 pcs	bronze
4713 018	0,18 mm	18	30 cm	6,5 lbs / 3,00 kg	8 pcs	bronze

Trade Pack 10 Pieces



### Braid Feeder Leader Method Push Stop

Short Method hooklengths on ultra-soft braided line. With push stop on the hair for simple bait attachment. Barbless.

Code	Hook Size	Leader L. Ø	Hooklength	BS	Content	Colour
4720 012	6	0,12 mm	10 cm	6,4 kg / 14 lbs	3 pcs	bronze
4720 014	4	0,14 mm	10 cm	7,3 kg / 16 lbs	3 pcs	bronze
4720 112	8	0,12 mm	10 cm	6,4 kg / 14 lbs	3 pcs	bronze

Trade Pack 10 Pieces



### Feeder Leader Big Fish FC

All-round feeder hooklengths with robust Mustad hooks and invisible fluorocarbon leader material. Ideal for bream and other feisty coarse fish. Hooks: Mustad 60345NP-BR.

Code	Ø	Hook Size	Hooklength	BS	Content	Colour
4705 212	0,19 mm	12	60 cm	2,7 kg / 6,0 lbs	5 pcs	bronze
4705 214	0,16 mm	14	60 cm	1,90 kg / 4,0 lbs	5 pcs	bronze
4705 216	0,14 mm	16	60 cm	1,45 kg / 3,0 lbs	5 pcs	bronze

Trade Pack 10 Pieces



### Braid Feeder Leader Method Boilie Needle

Short Method hooklengths on ultra-soft braided line. With a boilie needle on the hair for simple bait attachment with particularly robust Mustad hook.

Code	Hook Size	Leader L. Ø	Hooklength	BS	Content	Colour
4721 012	6	0,12 mm	10 cm	6,4 kg / 14 lbs	3 pcs	bronze
4721 014	4	0,14 mm	10 cm	7,3 kg / 16 lbs	3 pcs	bronze
4721 112	8	0,12 mm	10 cm	6,4 kg / 14 lbs	3 pcs	bronze

Trade Pack 10 Pieces



### Feeder Leader Master FC

Versatile feeder hooklengths with ultra-sharp Mustad hooks and invisible fluorocarbon monofilament. Hooks: Mustad 60332NP-BR.

Code	Ø	Hook Size	Hooklength	BS	Content	Colour
4709 212	0,16 mm	12	60 cm	1,90 kg / 4,0 lbs	5 pcs	bronze
4709 214	0,14 mm	14	60 cm	1,45 kg / 3,0 lbs	5 pcs	bronze
4709 216	0,12 mm	16	60 cm	1,10 kg / 2,5 lbs	5 pcs	bronze
4709 218	0,12 mm	18	60 cm	1,10 kg / 2,5 lbs	5 pcs	bronze
4709 220	0,12 mm	20	60 cm	1,10 kg / 2,5 lbs	5 pcs	bronze

Trade Pack 10 Pieces



### Braid Feeder Leader Method Pellet Band

Short Method hooklengths on ultra-soft braided line. With pellet band on the hair for simple bait attachment with particularly robust Mustad hook.

Code	Hook Size	Leader L. Ø	Hooklength	BS	Content	Colour
4722 012	6	0,12 mm	10 cm	6,4 kg / 14 lbs	3 pcs	bronze
4722 014	4	0,14 mm	10 cm	7,3 kg / 16 lbs	3 pcs	bronze
4722 112	8	0,12 mm	10 cm	6,4 kg / 14 lbs	3 pcs	bronze

Trade Pack 10 Pieces



**NEW**



### Black Magic® Method Feeder

Method feeders in value-for-money design in weights of 20, 30 or 50 g. New design with larger contact surface.

Code	Weight	Content
6680 020	20 g	20 pcs
6680 030	30 g	20 pcs
6680 050	50 g	20 pcs

Trade Pack 20 Pieces

**NEW**



### Black Magic® Method Feeder Set

In-line, free-running, method feeder set comprising 2 x 20g and 2 x 30g flat feeders plus a matching mould suitable for groundbait or pellets. Reverse of pack has pictures and instructions for use.

Code	Content
6680 999	4 pcs

Trade Pack 10 Pieces

**NEW**



### Xenos Feeder

This plastic speed-feeder can be cast out very far and gives you added flexibility at the water's edge. The aerodynamically shaped lead weight can be replaced within seconds. Its innovative design allows you to fill many coarse particles and baits into the Xenos Feeder without them falling out during the cast. Special slots at the bottom of the cage help to release the feed quickly.

Code	Length	Weight
6679 030	4,0 cm	30 g
6679 040	4,0 cm	40 g
6679 050	4,0 cm	50 g
6679 060	4,0 cm	60 g
6679 080	4,0 cm	80 g

Trade Pack 20 Pieces

**NEW**



### Xenos Slow Sinking Feeder

Same design as the Xenos Feeder, but with an absolute innovation: you can control the cage's sinking speed to catch fish also near the surface or in mid-water. This is not feasible with conventional cage feeders. The Xenos Slow Sinking Feeder allows you to catch fish regardless of the depth they are at! This method is extremely effective for modern carp fishing at commercial fisheries. A floating device attached to the bottom of the cage replaces the lead weight. It features a small opening closed by a plug, by which you can balance the body with shot so that it will sink slowly or quickly. The cage floats if no lead is added.

Code	Length	Weight
6679 010	4,0 cm	12,5 g

Trade Pack 20 Pieces



### Hydrus Method Feeder

Innovative design of „open“ method feeder which holds bait firmly for casting, but has no bars to trap or mask the hookbait. Perfect presentation every time.

Code	Length	Width	Weight
6607 020	6,0 cm	3 cm	20 g
6607 030	6,0 cm	3 cm	30 g
6607 050	6,0 cm	3 cm	50 g
6607 080	6,0 cm	3 cm	80 g

Trade Pack 5 Pieces



### Hydrus Method Feeder

Matching groundbait moulder for the Browning Method Feeder. Flexible silicone design.

Code	Content
6607 999	4 pcs

Trade Pack 5 Pieces



### Coated Feeder L

Strong cage feeders coated in a textured and coloured finish to be invisible to fish in clear water. In a range of colours, sizes and weights.

Code	Length	Ø	Size	Weight	Colour
6656 020	3,5 cm	2,8 cm	L	20 g	brown
6656 030	3,5 cm	2,8 cm	L	30 g	brown
6656 040	3,5 cm	3,0 cm	L	40 g	brown
6656 060	4,0 cm	3,0 cm	L	60 g	brown
6656 080	4,0 cm	3,0 cm	L	80 g	brown
6656 100	4,0 cm	3,0 cm	L	100 g	brown

Trade Pack 10 Pieces



### Coated Feeder M

Strong cage feeders coated in a textured and coloured finish to be invisible to fish in clear water. In a range of colours, sizes and weights.

Code	Length	Ø	Size	Weight	Colour
6657 020	2,5 cm	2,4 cm	M	20 g	brown
6657 030	2,5 cm	2,4 cm	M	30 g	brown
6657 040	2,5 cm	2,4 cm	M	40 g	brown
6657 060	2,5 cm	2,4 cm	M	60 g	brown

Trade Pack 10 Pieces





### Big Pit Inline Feeder

Swimfeeder with large holes. Internal ridges ensure the groundbait is held securely. With internal line guide.

Code	Length	Ø	Size	Weight	Content
6621 220	3 cm	2,5 cm	M	20 g	1 pcs
6621 225	3 cm	2,5 cm	M	25 g	1 pcs
6621 230	3 cm	2,5 cm	M	30 g	1 pcs
6621 240	3 cm	2,5 cm	M	40 g	1 pcs

Trade Pack 20 Pieces



### Big Pit Standard Feeder

Particularly large swimfeeder with large holes. Internal ridges ensure the groundbait is held securely. Material: Plastic

Code	Length	Ø	Size	Weight	Content
6621 020	3 cm	2,5 cm	M	20 g	1 pcs
6621 025	3 cm	2,5 cm	M	25 g	1 pcs
6621 030	3 cm	2,5 cm	M	30 g	1 pcs
6621 040	3 cm	2,5 cm	M	40 g	1 pcs
6621 050	3 cm	2,5 cm	M	50 g	1 pcs

Trade Pack 20 Pieces



Indestructible stainless steel design!



### Speed Baiter

A variant on the classic speed feeder with a larger wire mesh that releases the bait extremely quickly. Designed for days when bites come quickly!

Code	Length	Ø	Weight
6636 030	3,4 cm	2,6 cm	30 g
6636 040	3,4 cm	2,6 cm	40 g
6636 050	3,4 cm	2,6 cm	50 g
6636 060	3,4 cm	2,6 cm	60 g
6636 070	3,4 cm	2,6 cm	70 g
6636 080	3,4 cm	2,6 cm	80 g
6636 100	3,4 cm	2,6 cm	100 g

Trade Pack 10 Pieces



### Jet Feeder

Innovative swimfeeder with jet-like design. Residual groundbait is rapidly rinsed out during the retrieve. Outstanding casting properties.

Code	Length	Ø	Size	Weight
6606 020	2,5 cm	3 cm	S	20 g
6606 030	2,5 cm	3 cm	S	30 g
6606 040	2,5 cm	3 cm	S	40 g
6606 060	2,5 cm	3 cm	S	60 g
6606 080	2,5 cm	3 cm	S	80 g
6606 120	4 cm	3 cm	L	20 g
6606 130	4 cm	3 cm	L	30 g
6606 140	4 cm	3 cm	L	40 g
6606 160	4 cm	3 cm	L	60 g
6606 180	4 cm	3 cm	L	80 g

Trade Pack 10 Pieces



### Big Pit Large Feeder

Particularly large swimfeeder with large holes. Internal ridges ensure the groundbait is held securely. Material: Plastic

Code	Length	Ø	Size	Weight	Content
6621 120	4 cm	3 cm	XL	20 g	1 pcs
6621 125	4 cm	3 cm	XL	25 g	1 pcs
6621 130	4 cm	3 cm	XL	30 g	1 pcs
6621 150	4 cm	3 cm	XL	50 g	1 pcs
6621 160	4 cm	3 cm	XL	60 g	1 pcs

Trade Pack 20 Pieces



**NEW**

### Big Pit Mini Feeder

The smaller version of the big brother: first-class plastic swimfeeder with large holes. Internal ridges ensure the groundbait is held securely.

Code	Length	Weight
6621 315	2,4 cm	15 g
6621 320	2,4 cm	20 g
6621 325	2,4 cm	25 g
6621 330	2,4 cm	30 g
6621 340	2,4 cm	40 g

Trade Pack 20 Pieces



New smaller sizes added!

### Window Feeder UKWF

An update of our unique and famous Window Feeder. Fill with maggots, close the window and you're ready to cast! End weighted design means easy and accurate casting and allows the maggots to escape quickly when on the bottom.

Code	Length	Ø	Size	Weight	Content
6628 020	5,0 cm	2,6 cm	L	20 g	1 pcs
6628 035	5,0 cm	2,6 cm	L	35 g	1 pcs
6628 050	5,0 cm	2,6 cm	L	50 g	1 pcs
<b>NEW</b> 6628 135	3,8 cm	2,2 cm	M	35 g	1 pcs
<b>NEW</b> 6628 145	3,8 cm	2,2 cm	M	45 g	1 pcs

Trade Pack 10 Pieces



### Window Feeder CWF

A second, multi-purpose, version of our Window feeder with a permanently open window. Fill with any bait, close window with groundbait and cast. Tube has a second window that can be opened if faster emptying is needed.

Code	Length	Ø	Weight	Content
6629 020	5,0 cm	2,6 cm	20 g	1 pcs
6629 035	5,0 cm	2,6 cm	35 g	1 pcs
6629 050	5,0 cm	2,6 cm	50 g	1 pcs
6629 070	5,0 cm	2,6 cm	70 g	1 pcs

Trade Pack 10 Pieces



Available in counter display boxes – see next pages.



**Window Feeder Classic**

Improved re-make of our classic and patented Window Feeder. Can be used 2 ways - fill with maggots and turn the sleeve to close the window or fill with any particle bait and closing the window with a smear of ground bait for rapid emptying. Casts long and straight due to the end weight design. Material: Plastic

Code	Length	Weight	Colour
6622 020	4,4 cm	20 g	green
6623 035	5,3 cm	35 g	green
6623 050	5,3 cm	50 g	green
6624 035	5,8 cm	35 g	green
6624 050	5,8 cm	50 g	green

Trade Pack 20 Pieces



**Window Feeder Set**

Containing: each 20x 6622 020, 6623 035, 6623 050, 6624 035, 6624 050

Code	Material	Colour
6624 999	Plastic	green

Indestructible stainless steel design!



**Specialist Feeder**

Special feeder for use in flowing water, with a flat design enables the lead to hold the bottom particularly well. This allows the angler to use smaller weights than usual.

Code	Length	Ø	Weight
6667 020	3,0 cm	3,0 cm	20 g
6667 030	3,0 cm	3,0 cm	30 g
6667 040	3,0 cm	3,0 cm	40 g
6667 041	5,0 cm	5,0 cm	40 g
6667 050	3,0 cm	3,0 cm	50 g
6667 051	5,0 cm	5,0 cm	50 g
6667 060	3,0 cm	3,0 cm	60 g
6667 061	5,0 cm	5,0 cm	60 g

Trade Pack 10 Pieces

Indestructible stainless steel design!



**Specialist Feeder**

Special feeder for use in flowing water, with a flat design enables the lead to hold the bottom particularly well. This allows the angler to use smaller weights than usual.

Code	Length	Ø	Weight
6667 080	3,0 cm	3,0 cm	80 g
6667 081	5,0 cm	5,0 cm	80 g
6667 101	5,0 cm	5,0 cm	100 g
6667 121	5,0 cm	5,0 cm	120 g
6667 141	5,0 cm	5,0 cm	140 g
6667 161	5,0 cm	5,0 cm	160 g
6667 181	5,0 cm	5,0 cm	180 g

Trade Pack 10 Pieces

Extremely robust due to infused lead



**Wire Match Feeder**

These wire cage feeders are virtually indestructible. The wire and loop are moulded into the lead giving a one piece feeder that can not come apart - perfect for repeated casting or snaggy conditions.

Code	Length	Ø	Weight
6662 010	4,0 cm	4,0 cm	10 g
6662 020	4,0 cm	4,0 cm	20 g
6662 021	4,5 cm	4,5 cm	20 g
6662 030	4,0 cm	4,0 cm	30 g
6662 031	4,5 cm	4,5 cm	30 g
6662 040	4,0 cm	4,0 cm	40 g
6662 041	4,5 cm	4,5 cm	40 g
6662 042	6,0 cm	6,0 cm	40 g
6662 051	4,5 cm	4,5 cm	50 g
6662 061	4,5 cm	3,0 cm	60 g
6662 062	6,0 cm	6,0 cm	60 g
6662 082	6,0 cm	6,0 cm	80 g
6662 102	6,0 cm	6,0 cm	100 g

Trade Pack 10 Pieces

Indestructible stainless steel design!

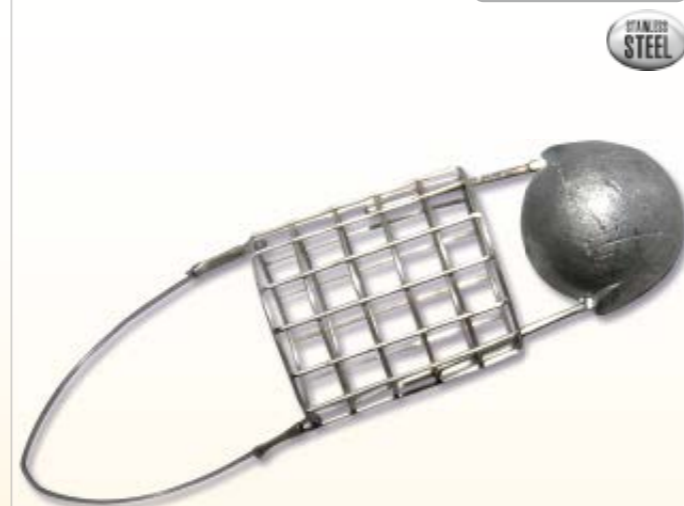

**Easy Speed Feeder**

Ideal feeder for fishing at extreme distances. Capable of use on the most diverse range of venues. Rear center of gravity ensures perfect flight qualities.

Code	Length	Ø	Weight
6669 020	3,5 cm	2,5 cm	20 g
6669 030	3,5 cm	2,5 cm	30 g
6669 040	3,5 cm	2,5 cm	40 g
6669 050	3,5 cm	2,5 cm	50 g
6669 060	3,5 cm	2,5 cm	60 g
6669 080	3,5 cm	2,5 cm	80 g

Trade Pack 10 Pieces

Indestructible stainless steel design!



**Landi Feeder**

Light, small stainless steel feeder for fishing on shallow waters and at close range.

Code	Length	Ø	Weight
6609 005	2,5 cm	2,0 cm	5 g
6609 008	2,5 cm	2,0 cm	8 g
6609 010	2,5 cm	2,0 cm	10 g
6609 015	2,5 cm	2,0 cm	15 g
6609 020	2,5 cm	2,0 cm	20 g

Trade Pack 20 Pieces





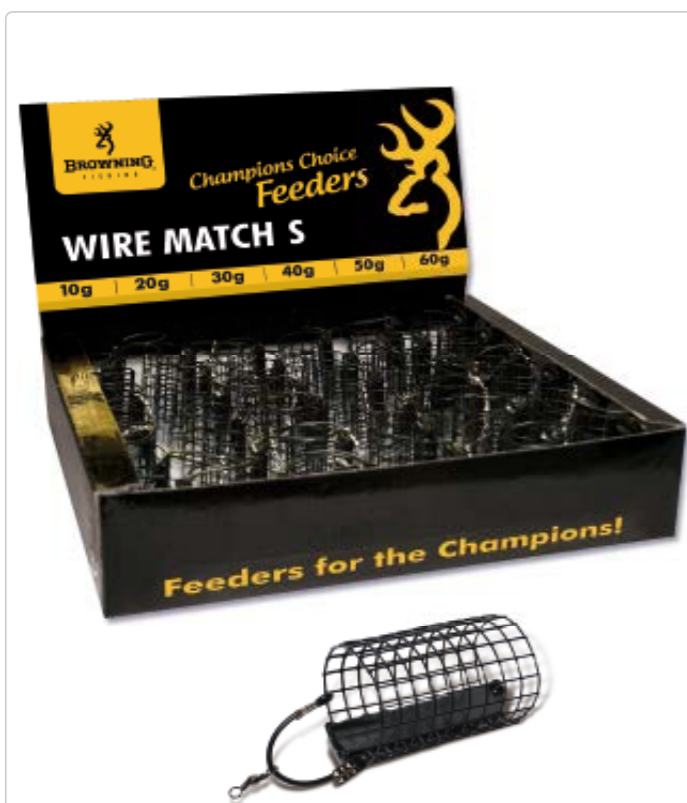

### Feeder Wire Match Small, Display

each 6x 6662 010, 020, 030, 040, 051, 061

Code	Content
6662 997	36 pcs



### Feeder Wire Match Medium, Display

each 6x 6662 021, 031, 041, 051, 062, 082

Code	Content
6662 998	36 pcs



### Feeder Specialist M, Display

each 6x 6667 020, 030, 040, 050, 060, 080

Code	Content
6667 998	36 pcs



### Feeder Specialist XL, Display

each 5x 6667 041, 051, 061, 081, 101, 121

Code	Content
6667 999	30 pcs

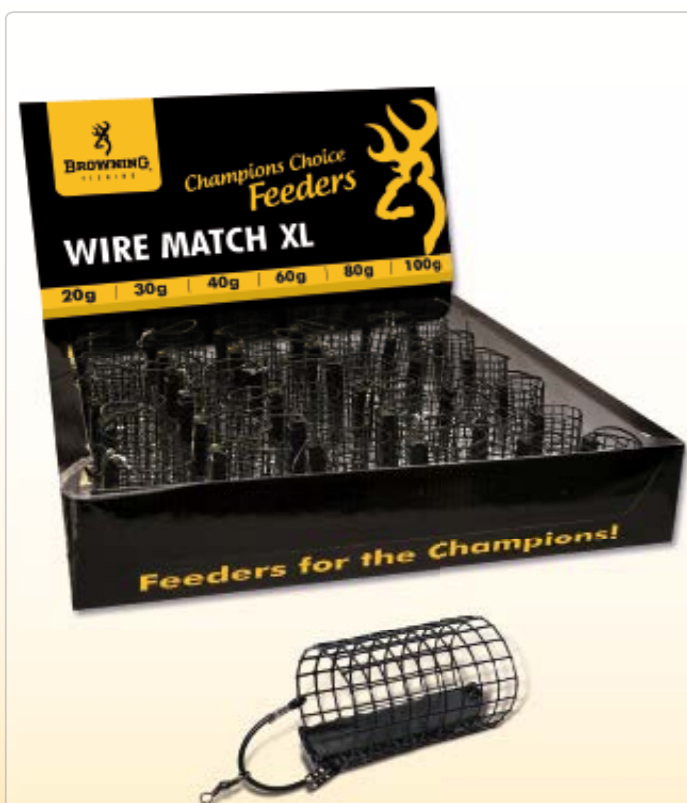

### Feeder Wire Match XL, Display

each 6x 6662 021, 031, 042, 062, 082, 102

Code	Content
6662 999	36 pcs

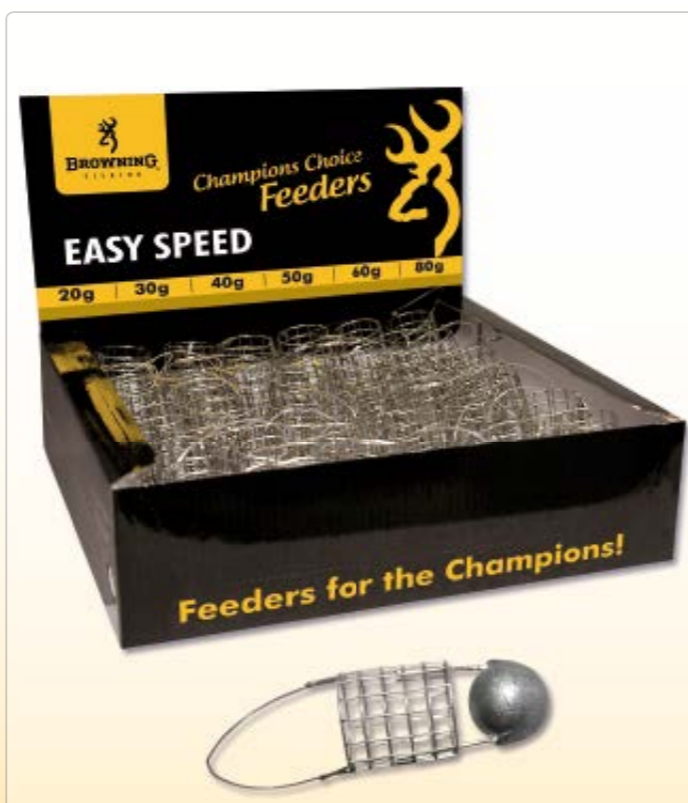

### Feeder Easy Speed, Display

each 6x 6669 020, 030, 040, 050, 060, 080

Code	Content
6669 999	36 pcs



### Coated Feeder, Display

each 6x 6657 020, 040, 060 and 6657 120, 140, 160

Code	Ø	Size	Colour
6657 999	3,0 cm	M	brown+green



### Jet Feeder Display

6x 30 g, 40 g, 60 g (S), 6x 30 g, 40 g, 80 g (L)

Code	Ø
6606 999	2,8 cm





**Big & Specimen Fish - Feeder Set (barbed)**

12-piece fishing tackle set including 4 swimfeeders and 8 feeder leaders.

**Code**  
6678 995  
Trade Pack 5 Pieces



**Big & Specimen Fish - Feeder Kit (barbless)**

12-piece fishing tackle set including 4 swimfeeders and 8 feeder leaders with barbless hooks.

**Code**  
6678 996  
Trade Pack 5 Pieces



**Micro Shot Dispenser**

Code	Size	Weight
6010 013	13	0,013 g
6010 012	12	0,019 g
6010 011	11	0,028 g
6010 010	10	0,040 g
6010 009	9	0,056 g
6010 008	8	0,070 g
6010 007	7	0,088 g
6010 006	6	0,112 g
6010 005	5	0,135 g
6010 004	4	0,177 g
6010 003	3	0,221 g
6010 002	2	0,271 g
6010 001	1	0,295 g
6010 000	0	0,390 g
6010 200	2/0	0,425 g
6010 300	3/0	0,470 g
6010 400	4/0	0,677 g
6010 500	AAA	0,690 g
6010 600	5G	1,180 g
6010 800	SSG	1,770 g

Trade Pack 10 Pieces



**Bream & Other Silverfish - Feeder Set (barbed)**

12-piece fishing tackle set including 4 swimfeeders and 8 feeder leaders. Barbed hooks.

**Code**  
6678 997  
Trade Pack 5 Pieces



**Bream & Other Silverfish - Feeder Kit (barbless)**

12-piece fishing tackle set including 4 swimfeeders and 8 feeder leaders. Barbless.

**Code**  
6678 998  
Trade Pack 5 Pieces



**Carp Method Feeder - Full Kit**

11-piece fishing tackle set for method feeder fishing including 2 swimfeeders, a ball maker and 8 suitable leaders with pellet bands. Barbless.

**Code**  
6678 999  
Trade Pack 5 Pieces



**Lead Assortment**

7 sizes, 8 to SSG.

**Code Model**  
6010 998 Match  
Trade Pack 10 Pieces



**Lead Assortment**

5 sizes, 12 to 8.

**Code Model**  
6010 999 Micro  
Trade Pack 10 Pieces



lead free

**Plummet Set 8, 15, 20g**

Practical set of three of the most popular plummet sizes in lead free brass design with plastic inserts to protect hooks when attaching to the rig.

**Code**  
6036 999  
Trade Pack 10 Pieces

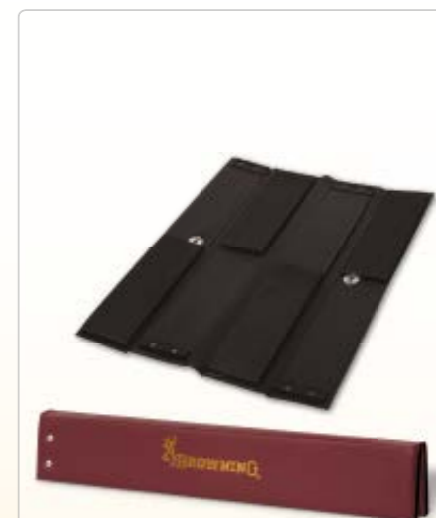

**Hook length Wallet**

Practical for transporting ready made hook lengths. Now also available in 15cm, perfect for Method leaders!

Code	Length
6603 003	25 cm
6603 002	35 cm
6603 004	40 cm
6603 006	15 cm

Trade Pack 5 Pieces





### Round Rig Wallet

An alternative way of storing hooklengths, however long or short, without kinking and tangling. Round EVA winders stored in a hard tube with zip-up Cordura cover to protect line from the elements.

Code	Length	Ø
8518 027	220 mm	45 mm

Trade Pack 5 Pieces



### Push Stops M

A handy and popular aid for quickly rigging up mini-boilies, pellets or particles onto hair rigs.

Code	Length	Colour
6608 001	7 mm	transparent
6608 002	9 mm	transparent

Trade Pack 10 Pieces



### Connector Bead

Code	Size	Content
3371 001	medium	10 pcs
3371 002	large	10 pcs

Trade Pack 5 Pieces



### Bait Stop Rigger

Ready-made rig, complete with push stops and silicone baitholder, tied up with soft braid.

Code	Length	Content
6608 010	15 mm	2 pcs
6608 011	21 mm	2 pcs

Trade Pack 10 Pieces



### Push Stop Needle

An important tool for feeding push stops through the bait.

Code	Length	Ø	Content
6602 040	3 cm	1 mm	1 pcs

Trade Pack 10 Pieces



### Push Stop Drill

An important tool for pre-drilling hard baits in order to feed through push stops.

Code	Length	Ø	Content
6602 041	3 cm	1,5 mm	1 pcs

Trade Pack 10 Pieces

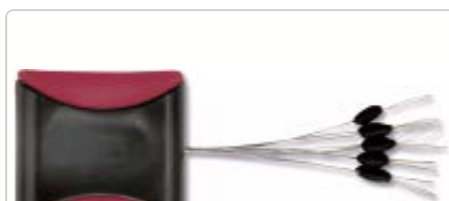

### Xitan Super Stopper oval

Code	Size	Content
3155 005	M	10 pcs
3155 006	L	10 pcs

Trade Pack 10 Pieces



### Swivel Stops

Code	Size	Content
6691 001	medium	5 pcs
6691 002	large	5 pcs

Trade Pack 5 Pieces



### King Feeder Micro Swivels

Very small and unobtrusive barrel swivels with a variety of uses

Code	Size	BS	Content
6200 001	8	19 kg	20 pcs
6200 002	10	14 kg	20 pcs
6200 003	12	9 kg	20 pcs
6200 004	14	4 kg	20 pcs

Trade Pack 10 Pieces



### Peg Cleaner

Ingenious lead weight with two sickles. Allows anglers to easily clear the vegetation from their swim with a feeder rod.

Code	Model	Weight	Content
6668 080	M	80 g	1 pcs
6668 120	L	120 g	1 pcs

Trade Pack 5 Pieces



### Feeder Link Pro

Professional feeder rig that enables rapid rigging when feeder fishing.

Code	Model
6690 001	S
6690 002	SM

Trade Pack 10 Pieces



### Easy Swap Swivel

Practical side mounting system with ready-positioned line stops. Simply tie on and away you go! e.g. for use with wagglers.

Code	Length	Content
6147 001	27 mm / 17 mm	5 pcs

Trade Pack 10 Pieces



### Instant Snap Swivel

Link swivels for a multitude of uses including quick-changing swimfeeders, bombs etc.

Code	Length	Content
6147 002	22 mm / 17 mm	5 pcs

Trade Pack 10 Pieces



### Specialist Feeder Rig

Perfect feeder rig developed by the specialist anglers of Browning Team Denmark. Totally eliminates tangling. Feeders can be changed instantly.

Code
6619 002

Trade Pack 10 Pieces



### Feeder-Rig I

Shock Absorber, specially designed by the Browning Team

Code
6619 001

Trade Pack 10 Pieces



### Method Connector Swivel

Quick change connection for method angling.

Code	Length	Content
6123 002	15 mm	3 pcs

Trade Pack 10 Pieces

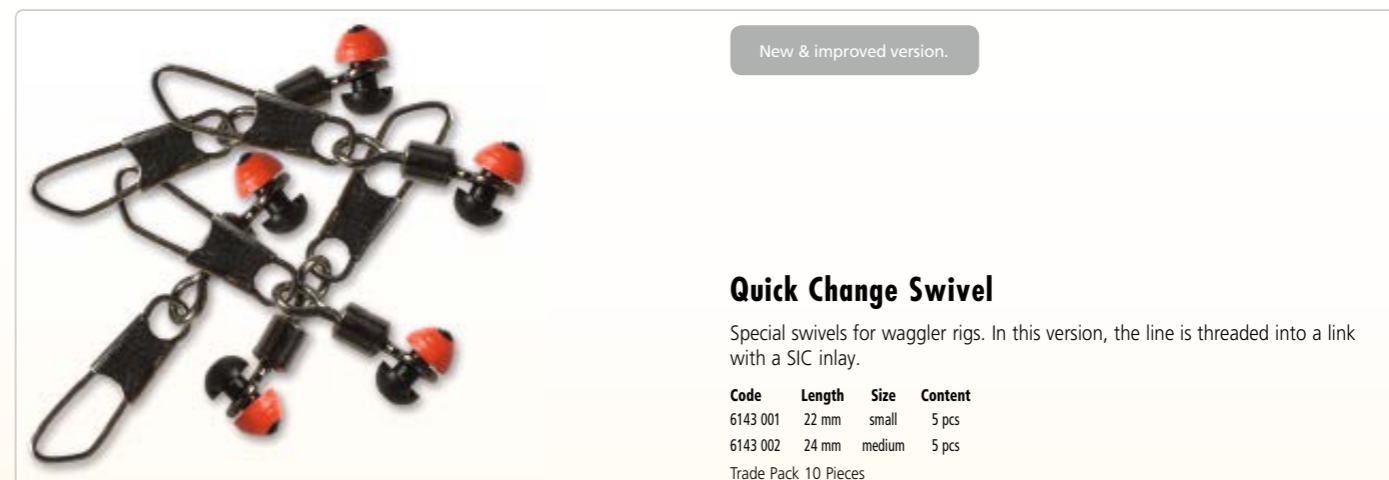

New & improved version.

### Quick Change Swivel

Special swivels for waggler rigs. In this version, the line is threaded into a link with a SIC inlay.

Code	Length	Size	Content
6143 001	22 mm	small	5 pcs
6143 002	24 mm	medium	5 pcs

Trade Pack 10 Pieces



### Feeder-Rig II

A tried and tested system for avoiding line tangle when feeder fishing: This loop rig with twirling line.

Code	Ø
6620 001	2,5 mm

Trade Pack 10 Pieces





**Kosch Rig MH**

The lightest running rig on the market that can also be used under international match rules. Every possible weight saving has been made to entice even the most cautious fish to bite. The system is based upon a 10-metre, specially-developed leader. Available in 0.22m (up to 30 metres fishing distance) and 0.26mm (up to 60 metres) line diameter.

Code	Length	Ø	Hook Size	Hook	Content
6620 002	10 m	0,26 mm	16	1	3 pcs

Trade Pack 10 Pieces



**Kosch Rig M**

The lightest running rig on the market that can also be used under international match rules. Every possible weight saving has been made to entice even the most cautious fish to bite. The system is based upon a 10-metre, specially-developed leader. Available in 0.22m (up to 30 metres fishing distance) and 0.26mm (up to 60 metres) line diameter.

Code	Length	Ø	Hook Size	Hook	Content
6620 003	10 m	0,22 mm	16	1	3 pcs

Trade Pack 10 Pieces



**Paternoster Kosch Rig**

The conventional side arm rig with a window feeder as used in Holland and Ireland for small fish. The direct bite indication enables lightning fast strikes.

Code	Length	Ø	Hook Size	Hook	Content
6620 004	10 m	0,26 mm	16	1	1 pcs

Trade Pack 10 Pieces



**Disgorger**

Flexible, highly efficient plastic disgorger.

Code	Length
6300 001	19 cm

Trade Pack 10 Pieces



**Knot Picker / Disgorger**

Leaders can knot very easily. But it is not always necessary to change them. With the knot un-picker, the solution is at your fingertips. Including the perfectly designed Browning disgorger.

Code
6325 001

Trade Pack 10 Pieces



**Hook Slave II**

A miracle accessory: a battery powered hook tier that saves hours of fumbling with the business end of the rig. Produces clean knots with optimal line protection during tying. Batteries: 2xAAA (not included).

Code	Content
9912 004	1 pcs

Trade Pack 3 Pieces



**Fish Counter**

A screw-on variant that can be securely mounted, using a standard fitting, on seat boxes and platforms.

Code
9890 015

Trade Pack 5 Pieces



**Fish Counter**

Essential when you need to keep on top of the exact number or weight of fish in your net. Especially useful in the UK, where only certain quantities per net are allowed.

Code
9890 010

Trade Pack 5 Pieces

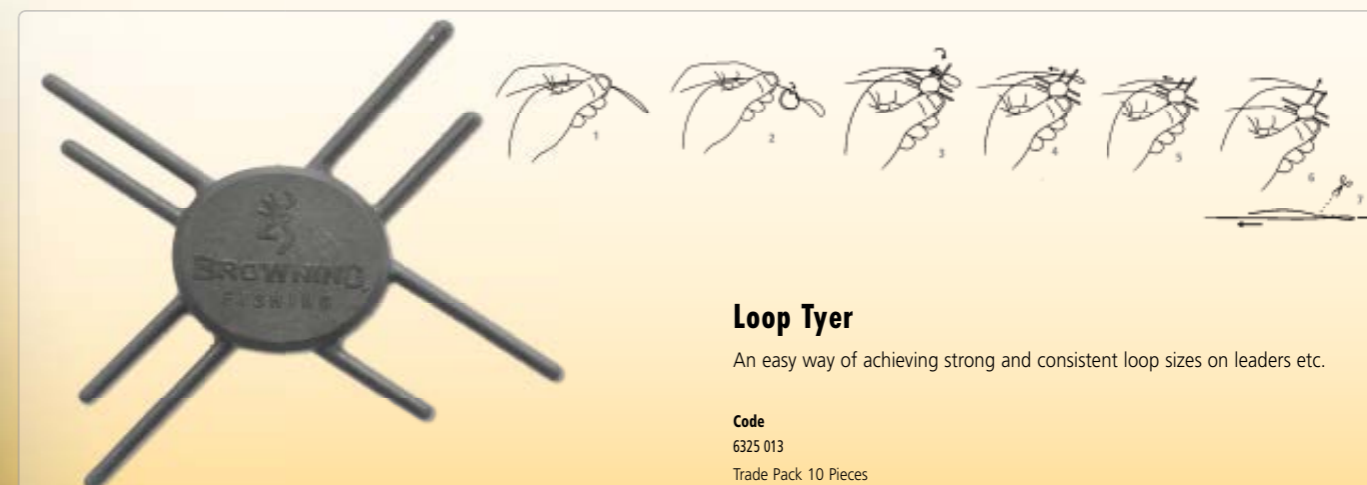

**Loop Tyer**

An easy way of achieving strong and consistent loop sizes on leaders etc.

Code
6325 013

Trade Pack 10 Pieces

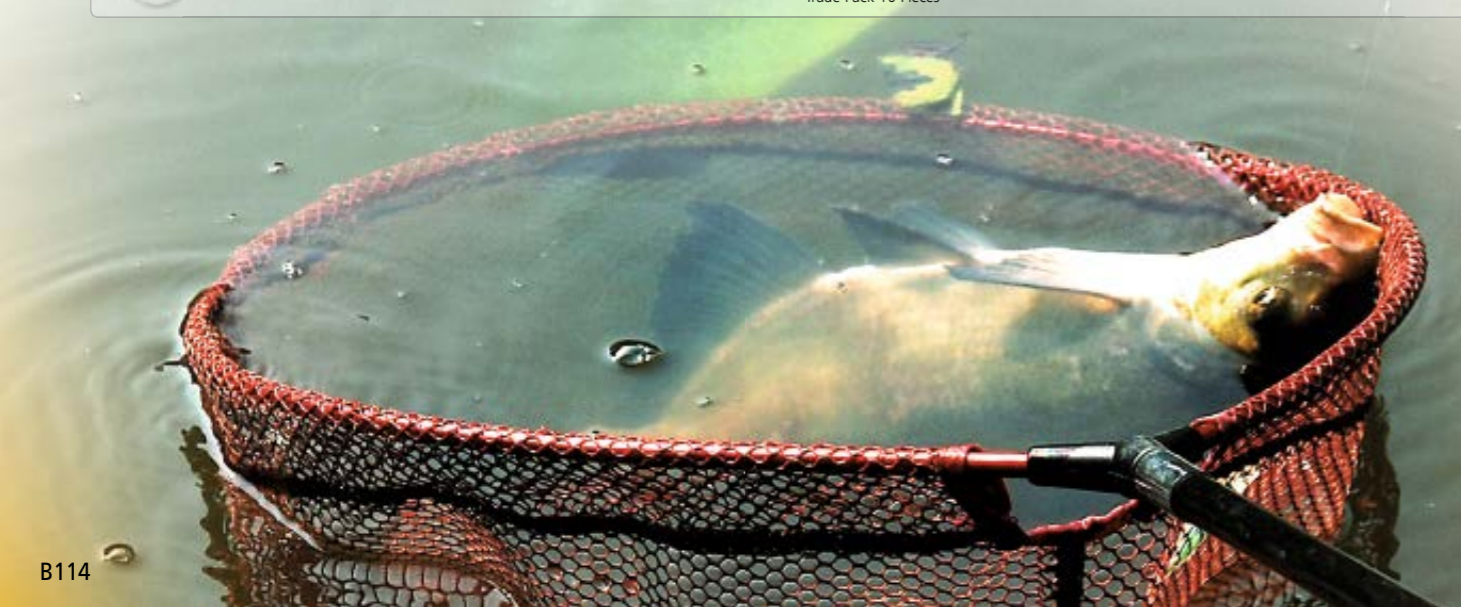





### Digital Match Scales

Accurate and reliable weighing of catches is an essential part of every angling event. These Browning digital scales make the task very easy and quick. Batteries: 2xAAA (not included).

Code	Interval	Weighing Range
9890 013	5 g	25 kg



### Line Clipper Deluxe

Practical line clipper. Useful for tying rigs or hooklengths.

**Code**  
6409 002  
Trade Pack 5 Pieces



### Braid Scissor

Sharp, fine scissors for hard-to-cut braid but also good for cutting or trimming everything else.

**Code**  
6409 001  
Trade Pack 5 Pieces



### Match Carp Tool Kit

A fantastic solution for all anglers who frequently visit commercial carp waters. Every important tool in one secure case, including a rig board for storing leaders situated internally. Contains two boilie and pellet drills, a threader, a knot picker, three boilie needles, a disgorger, braid scissors, forceps and three bait punches, as well as 10 rig board needles.

**Code**  
6603 001



yellow



purple



green



fluo yellow



fluo green



pink



orange



red

### Elastics Super Visibility

Coloured high performance elastics with long life and enormous stretch properties.

Length	Ø	Rating	yellow	purple	green	fluo yellow	fluo green	pink	orange	red
6 m	0,60 mm	2	6003 009							
6 m	0,70 mm	3	6003 010							
6 m	0,80 mm	4		6003 006						
6 m	0,90 mm	5			6003 007					
6 m	1,00 mm	6				6003 008				
6 m	1,20 mm	8					6003 001			
6 m	1,40 mm	10						6003 002		
6 m	1,60 mm	12							6003 003	
6 m	1,80 mm	14								6003 004
6 m	2,10 mm	16					6003 005			

Trade Pack 5 Pieces



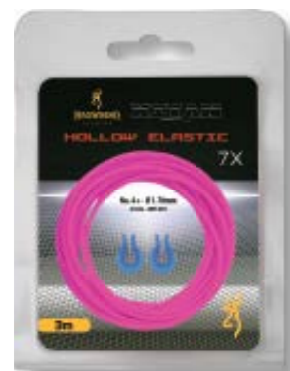

pink



blue



yellow



white



green



orange



red



lite blue

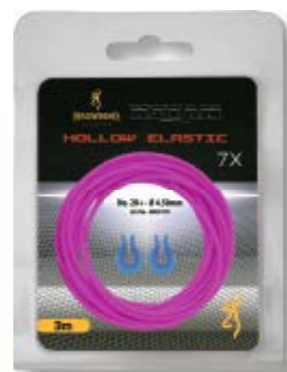

burgundy

**Stretch 7 Hollow Pole Elastic**

The best hollow elastic available. This surgical quality, 100% pure natural, latex elastic has a stretch factor of 7 times its original length. Perfectly round with a small internal bore that eliminates air bubbles, and with a surface finish that gives ultra smooth running. In 10 popular sizes to cover every pole fishing situation, including 2 extra large sizes that will tame the largest fish that swim.

Length	Ø	Rating	pink	blue	yellow	white	green	orange	red	lite blue	burgundy
3 m	1,70 mm	4+	6085 001								
3 m	1,90 mm	6+		6085 002							
3 m	2,10 mm	8+			6085 003						
3 m	2,30 mm	10+				6085 004					
3 m	2,50 mm	12+					6085 005				
3 m	2,70 mm	14+						6085 006			
3 m	3,10 mm	18+							6085 007		
3 m	3,50 mm	20+						6085 008			
3 m	4,00 mm	25+							6085 009		
3 m	4,50 mm	30+								6085 010	

Trade Pack 5 Pieces



lime green



orange



pink



blue/pearl



hunter green



rocket red



**Xitan Microbore Pole Elastic**

Xitan Microbore elastic offers major advantages over conventional hollow elastic. A smaller centre tube means that Xitan Microbore is around 30% thinner & lighter than the equivalent standard hollow, but retains the same 7x stretch factor. Microbore also runs much smoother under load as it resists flattening at the bush under pressure. In test it also lasted longer. The smaller sizes are the perfect silverfish and F1 elastics.

Length	Ø	Rating	lime green	orange	pink	blue/pearl	hunter green	rocket red
3 m	1,30 mm	3-5	6350 001					
3 m	1,50 mm	5-7		6350 002				
3 m	1,90 mm	7-9			6350 003			
3 m	2,30 mm	9-13				6350 004		
3 m	2,70 mm	13-17					6350 005	
3 m	3,00 mm	17-21						6350 006

Trade Pack 5 Pieces



**Dacron Connector**

A very compact design of dacron pole connector with bright, soft rubber, tulip shaped sleeves which cover even the largest elastic knots.

Code	Content
6008 013	4 pcs

Trade Pack 10 Pieces

**PTFE lined Pulla Stop Beads**

Stopper beads for elastics with Teflon bush guide. Indispensable for all puller kits. The diameter of the stop should be approx. 0.5-1 mm smaller than the diameter of the elastic. For example, a 1.6 mm stop matches a 2.3mm hollow elastic.



Code	Ø	Content
6189 001	1,9 mm	3 pcs
6189 002	2,3 mm	3 pcs
6189 003	2,6 mm	3 pcs
6189 004	3,0 mm	3 pcs
6189 005	3,5 mm	3 pcs
6189 006	4,0 mm	3 pcs
6189 010	1,0 mm	3 pcs
6189 011	1,3 mm	3 pcs
6189 012	1,6 mm	3 pcs

Trade Pack 10 Pieces

**Xitan Superbright Connectors**

Durable pole connectors in a range of sizes and bright colours. 5 per packet with elastic size guide.

Code	Length	Ø	Content
6064 001	9,0 mm	3,30 mm	5 pcs
6064 002	13,5 mm	3,40 mm	5 pcs
6064 003	18,0 mm	4,00 mm	5 pcs
6064 004	17,0 mm	5,00 mm	5 pcs
6064 005	20,6 mm	6,00 mm	5 pcs

Trade Pack 5 Pieces

Medium fits Browning top-kits perfectly.



**Bung-Set**

Bungs for rigging elastic with a winder to adjust the tension. Available in twodifferent diameters. Delivered as a set with 3 or 2 bungs and an extractor.

Code	Model	Ø	Content
6026 001	small	13,5 mm	3 pcs
6026 002	medium	20,0 mm	2 pcs
6026 003	large	28,5 mm	2 pcs

Trade Pack 5 Pieces





## Xitan Advance Pole Winder Bung

A new concept of pole winder bung that stores the elastic behind the cone. The larger winder can store large diameter elastics and is easier to extract than normal bung designs. 21.5 mm diameter fits Browning poles perfectly and can be cut to fit other section sizes.

Code	Ø	Size	Content
6026 005	21,5 mm	M	2 pcs

Trade Pack 5 Pieces



## Xitan pure black PTFE external pole bushes

Made from aero quality black PTFE, these external pole bushes are thin walled to create the biggest possible hole size and are designed to eliminate splitting at the rear edge. The black colour is very unobtrusive on the pole. 2 bushes per pack, which has a measurement guide so tip fit size can be checked without removing the bush from packet.

Code	Ø	Content
6063 001	3,00 mm	2 pcs
6063 002	3,50 mm	2 pcs
6063 003	4,00 mm	2 pcs
6063 004	4,50 mm	2 pcs
6063 005	5,00 mm	2 pcs
6063 006	5,10 mm	2 pcs

Trade Pack 5 Pieces



## Xitan pure BLACK PTFE internal pole bushes

Made from aero quality black PTFE, these internal pole bushes are short to reduce friction, and thin walled to give the largest possible hole size. The Black colour makes topkits look very smart! 2 bushes per pack, which has a measurement guide so tip fit size can be checked without removing the bush from packet.

Code	Ø	Content
6062 001	3,60 mm	2 pcs
6062 002	4,00 mm	2 pcs
6062 003	4,20 mm	2 pcs
6062 004	4,50 mm	2 pcs
6062 005	4,90 mm	2 pcs
6062 006	5,20 mm	2 pcs
6062 007	5,40 mm	2 pcs

Trade Pack 5 Pieces



## CC Competition Seatbox

Browning Maxi-Lite Seatboxes – modern, good looking and very practical. Browning's range of seatboxes have been carefully designed to be compact and light in weight, but still provide plenty of space for rigs and tackle. The main frame of the box is more compact and lower in height than similar designs. This makes easier for a wider range of anglers to find a comfortable seating position. The new style cassette footplate design is compact and light in weight, but keeps the box very stable and secure. The Competition seatbox is supplied with a totally new design of adjustable short leg for anglers who mainly fish from platforms. This leg has reduced height adjustment, but keeps the box very low to the ground and is generally more compact than full length legs. Conventional standard height adjustable legs are also available.

The Maxi-Lite Competition Box features::

- Underseat 20mm tray
- 35mm deep, side opening drawer:
- 2x 20mm shallow tray for pole winders
- 80mm deep tray
- Tray lid unit
- The new design of multi-adjustable short leg. Additional trays are available.

Code
8017 001



## Pole Elastic Alignment Bushes

Fit inside the topkit joint to stop elastic rubbing inside the section. Soft EVA outer can be compressed to fit a range of joint sizes. Pure PTFE liner makes elastic run perfectly smooth.

Size 1 (11mm) fits 9mm to 11mm joints

Size 2 (14mm) fits 12mm to 14mm joints

Size 3 (19mm) fits 11mm to 19mm joints

Code	Ø	Content
6340 001	11 mm	2 pcs
6340 002	14 mm	2 pcs
6340 003	19 mm	2 pcs

Trade Pack 5 Pieces



## Pulla Bush oval

As fitted to our Xitan Z14-1 pole. A new innovative design of directional side puller bush. The internal shape of the bush eliminates all sharp angles and provides totally smooth and reliable operation, without any moving parts. Moulded in top quality PTFE and supplied with a drilling guide for easy fitting.

Code	Model	Ø	Content
6002 005	L	- 4,5 mm	2 pcs
6002 006	XL	- 6,0 mm	2 pcs

Trade Pack 10 Pieces



## Side Drawer Tray

Code	Width	Height	Depth
8017 107	41 cm	9 cm	28,5 cm



## Lid Unit

Code	Width	Height	Depth
8017 108	41 cm	2 cm	28,5 cm





## CC Feeder Seatbox

Browning Maxi-Lite Seatboxes – modern, good looking and very practical.

Browning's range of seatboxes have been carefully designed to be compact and light in weight, but still provide plenty of space for rigs and tackle. The main frame of the box is more compact and lower in height than similar designs. This makes easier for a wider range of anglers to find a comfortable seating position. The new style cassette footplate design is compact and light in weight, but keeps the box very stable and secure. The Feeder seatbox is supplied with standard height adjustable legs with tilting mudfeet.

The Maxi-Lite Feeder Box features:

- Underseat 20mm tray
- Two deep front opening drawers
- 40mm medium tray
- Tray lid unit
- Conventional long adjustable legs

**Code**  
8017 002

### Trays

Code	Model	Width	Height	Depth	Content
8017 102	Tray	41 cm	2 cm	28,5 cm	2 pcs
8017 103	Tray	41 cm	4 cm	28,5 cm	1 pcs
8017 104	Tray	41 cm	6 cm	28,5 cm	1 pcs
8017 105	Tray	41 cm	8 cm	28,5 cm	1 pcs
8017 121	Lower Unit	41 cm	8 cm	28,5 cm	1 pcs

### Front Drawer Tray

Code	Width	Height	Depth
8017 106	41 cm	8 cm	28,5 cm

### Carry Belt

**Code**  
8017 101

Ø 25 mm  
30 mm  
36 mm

### Xitan X Standard Large Side Tray

Stable sidetray with support leg. Conveniently sized to fit in the front pocket of the typical carryall bag.

Code	Length	Width
8006 120	51 cm	40 cm

Ø 25 mm  
30 mm  
36 mm

### Standard Side Tray

Code	Width	Depth
8017 113	62 cm	53 cm

Ø 25 mm  
30 mm  
36 mm

### Xitan X Shelter Side Tray XL

Large and stable sidetray with cover to protect bait. Cover can be removed when not needed. Supplied with 2 support legs.

Code	Length	Width
8006 121	65 cm	45 cm

### Xitan X Feeder Rod Rest

Code	Model	Length
8006 125	XL	60 cm
8006 126	L	25 cm
8006 127	S	10 cm
8006 128	angled	25 cm

### Winder Tray

Winder storage tray complete with a set of 13 rig winders. Designed to fit Browning seatbox trays and many other brands perfectly. The winders are 18cm long, with sliding hooks on both sides which allow 2 pole rigs to be stored on each winder.

Code	Length	Width	Content
8019 110	26,5 cm	18 cm	15 pcs







## Xitan Compact Seat Box

An alternative Xitan box for anglers looking even lighter weight and greater flexibility. The frame of the Compact box frame is around 25% lighter than other Xitan boxes. The height adjustable top frame allows trays to be "stacked" above the frame, but still allows the distance between the footplate and seat cushion to be adjusted for comfort. The box still has a sliding type footplate to maintain rigidity and to make the box very stable. The Compact Box is fully compatible with all Xitan seat-box parts so additional trays can be added to fully customise the box to your needs.

**Code**  
8017 003

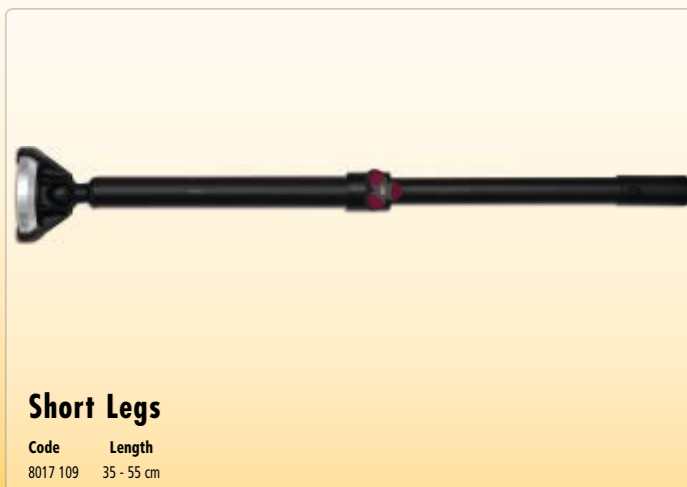

## Short Legs

**Code**    **Length**  
8017 109    35 - 55 cm



## Long Legs

**Code**    **Length**  
8017 110    52 - 82 cm



## Cruiser Trolley

A "Formula 1" trolley! The tricycle design is stable and very easy to push without any lifting. However, on areas of rough ground it can still be lifted and pushed as a conventional "wheelbarrow" trolley. All wheels are fitted with ball bearings for effortless pushing and the handle is height adjustable for comfort. The design is compact and stores nearly flat when taken apart for easy transport. Has a removable "drop" bag that sits between the base frame tubes and is useful for clothing etc. Suitable for Browning and most other similar seatboxes on the market.

Code	Length	Width	Weight
8705 007	87,00 cm	47,00 cm	13,5 kg



## Xitan X Side Tray Organizer Boxes

Code	Content
8006 133	5 items



## Screw on Leg Extension

Code	Length	Ø	Content
8017 119	14 cm	25 mm	1 pcs



Ø 25 mm  
30 mm  
36 mm



**Xitan X Straight Accessory/Net Bar**

Code  
8006 115

Ø 25 mm  
30 mm  
36 mm



**Xitan X EVA Pole Rest Set**

Set of 2 Pole support rests. Heavily padded to protect pole.

Code  
8006 116

Ø 25 mm



**Landing Net & Accessory Holder**

Code	Length	Size
8017 117	30 cm	L
8017 118	20 cm	S

Ø 25 mm



**EVA Rod Rest**

Code	Length
8017 114	49 cm

Ø 25 mm  
30 mm  
36 mm



**Xitan X EVA Rod Bar**

Code	Length
8006 117	50 cm

Ø 25 mm  
30 mm  
36 mm



**Xitan X 6 Position Kit Roost**

Code  
8006 113

Ø 25 mm



**Accessory Arm**

Code	Length
8017 111	36 cm

Ø 25 mm  
30 mm  
36 mm



**Xitan X Angled Accessory/Net Bar**

Code  
8006 114

Ø 25 mm  
30 mm  
36 mm



**Xitan X 10 Position Kit Roost**

Code	Length
8006 118	63 cm

Ø 25 mm  
30 mm  
36 mm



**Xitan X 12 Position Kit Roost**

Code	Length
8006 119	78 cm

Ø 25 mm  
30 mm  
36 mm



**Xitan X Leg Fitting with Accessory Bar**

Code	Model
8006 124	Leg
8006 134	Adapter 25-36 mm

Ø 25 mm  
30 mm  
36 mm



**Xitan X 25mm Pole Support Bar**

Rigid pole support bar to fit 25mm leg systems. Fully adjustable.

Code	Model
8006 122	25 mm
8006 123	36 mm

Ø 25 mm



**Universal Side Tray**

A medium sized and practical sidetray to fit Browning seatboxes and other systems with 25mm legs.

Code	Length	Width
8017 116	41 cm	38 cm

Ø 25 mm



**Ground Bait Side Tray**

Code	Length	Width
8017 115	61 cm	40 cm





**Feeder Chair**

A lightweight and practical chair for feeder and stationary fishing. The sturdy backrest with adjustable inclination ensures optimal seating comfort. Each of the four telescopic feet (Ø 25mm) can be adjusted in height. The seat is very comfortably upholstered. There is a shallow fold-out storage compartment underneath the seat. The feeder chair comes with a fabric case.

Code	Weight	Content
8018 001	6,2 kg	1



**King Feeder Chair**

Very stable, fully adjustable and comfortable feeder chair. Supplied complete with a large folding sidetray which fold and stores under the seat, plus a shoulder carry bag.

Code	Weight
8002 001	11,36 kg



**Universal foot rest**

Footrest system to fit all Browning feeder chairs. Fully adjustable and complete with legs

Code	Length	Width
8002 101	60 cm	42,50 cm





Ø 25 mm



### King Feeder Box Sidetray

Large capacity box type sidetray, with hinged lid, which gives complete rain and sun protection to bait and tackle.

Code	Length	Ø	Width	Height
8001 001	55 cm	25 - 30 cm	40 cm	20 cm

incl. 1 Leg



### Xitan Roto Chair

Flexible, rotating chair for feeder fishing with folding backrest and four height-adjustable legs. All customary 25mm add-on accessories can of course also be used with this chair thanks to the corresponding leg diameter.

Code
8010 001



### Xitan Roto Chair Deluxe

Ultra comfortable version of our popular feeder chair. The folding swivel seat is heavily padded so makes even the longest fishing session a dream.

Code	Weight
8003 001	8,82 kg



### Xitan Roto SB Top

Flexible, rotating chair attachment for feeder fishing with folding backrest. Fits all Xitan- and Black Magic seat boxes.

Code
8010 002





## Black Magic® Easy Box

Lightweight seat box in simple construction with spacious bottom compartment for reels and other fishing tackle. Ideal for beginners and occasional anglers who value no-frills technology which is still tried and trusted. Integrated side tray.

Code	Length	Weight
8004 001	58 cm	5,7 kg



## Black Magic® Easy Box Tray

Code	Length	Width	Height
8004 101	29 cm	41 cm	4 cm



## Black Magic® Easy Box Drawer unit

Code	Length	Width	Height
8004 102	29 cm	41 cm	9 cm



## Black Magic® Trolley Comfort Box

A new type of practical seatbox which has been designed to be compact in size, light in weight and very comfortable. The padded seat has a soft fold-up backrest for ultimate comfort while waiting for that bite ! The main box has a large central compartment with zip opening on the front panel. There are also three large zip-up external pockets - so enough space for everything. The 4 legs are individually adjustable so the box can always be made level on uneven banks. This is the perfect box for the angler looking for a compact box which is much lighter and more comfortable than the usual designs. Material: 100% Polyester

Code	Width	Height
8016 001	42 cm	52 cm



## Black Magic® Ultralight Comfort Box

A new type of practical seatbox which has been designed to be compact in size, light in weight and very comfortable. The padded seat has a soft fold-up backrest for ultimate comfort while waiting for that bite ! The main box has a large central compartment with zip opening on the front panel. There are also three large zip-up external pockets - so enough space for everything. The 4 legs are individually adjustable so the box can always be made level on uneven banks. This is the perfect box for the angler looking for a compact box which is much lighter and more comfortable than the usual designs. Material: 100% Polyester

Code	Width	Height
8016 002	42 cm	42 cm





**Black Magic® Comfort Chair & Sidetray set**

Compact and very comfortable chair system. The leg heights can be adjusted to the set angle of chair, or to level on uneven ground. Supplied complete with a useful sidetray which fits either side of the chair and stores in the back panel for easy carrying. Screw fitting also allows other accessories like rod rests to be attached. Material: 100% Nylon

Code	Length	Width	Height	Weight
9902 001	40 cm	50 cm	80 cm	5,5



**Black Magic® Deluxe Folding Trolley**

Very compact, strong but easy-to-fold and pull trolley system. Will take even large seatboxes, but folds to a small size for transporting

Code	Length	Width	Height	Weight
8702 001	45 cm	55 cm	1,05 m	4,9 kg



Small wheels also give the transport outstanding load capacity.

**Match Trolley**

Bad backs can now be a thing of the past with this practical Browning trolley. Strong enough to handle all of your equipment and so small when collapsed that it will easily fit in your car boot. Also supplied with high quality carrying bag.

Code	Height	Depth	Weight
8705 002	55 cm	50 cm	6 kg

Trade Pack 2 Pieces



**Bait Box**

A large, food quality, storage box with a tight clip-down lid. Ideal for protecting dry baits like ground bait & pellets from mice, etc. Also useful for carrying wetted ground bait to matches as prevents drying.

Code	Length	Contents
8514 009	37 cm	17 l

Trade Pack 5 Pieces

Ø 25 mm



**Bait Protector Side Tray**

Material: 100% Polyester

Code	Length	Ø	Width	Height
8017 120	62 cm	25 mm	42 cm	10 cm

Ø 25 mm



**Big Pit Deep Side Tray**

Large sidetray with raised edges which reduces the chance of tackle etc. being knocked off the tray when fishing. Very useful when fishing over water.

Code	Length	Ø	Width
8005 001	55 cm	25 - 30 mm	40 cm



Ø 25 mm



### Feeder Arm M

Compact, robust feeder arm for attachment to seat boxes. Material: Alu

Code	Length	Height
8204 003	60 - 90 cm	10 cm

Ø 25 mm



### Feeder Arm, long

The Feederarm long is the perfect complement to the Feederarm M. With its greater length, robust 2-point fixing and jerk-free square tubes, it is optimally suited to use on flowing water.

Code	Length	Ø
8408 001	80 - 135 cm	25 - 30 mm

Ø 25 mm



### Kit holder

This practical kit holder has a storage capacity of 4 kits. However, it can also be folded down to a small size for storage, allowing it to be easily transported in a rod holdall. A joint allows the angle of incline to be adjusted according to preference, meaning the holder can easily be used on difficult terrain.

Code	Length	Ø
8408 002	80 cm	25 - 30 mm

Ø 25 mm



### Feeder Rod Tube Holder

Simple rod tube holder for quickly packing away an unused rod or a top kit, e.g. while unhooking. With mounting for 25 mm leg systems.

Code
8202 001

Trade Pack 3 Pieces

Ø 25 mm  
30 mm  
36 mm



### Multi Bait Waiter

This side tray folds away economically for transport and holds up to 6 Black Magic bait boxes. Now, the angler can always have a wide selection of bait within easy reach.

Code	Ø
8007 001	25 - 36 mm



### Groundbait Bucket

Code	Contents
8514 005	17 l

Trade Pack 5 Pieces



### Bucket with lid and bowl

Code	Contents
8514 010	30 l

Trade Pack 5 Pieces



### Round Riddle

3 different mesh widths. Fits to 17l bucket 8514 005 or 8514 010.

Code	Ø	Mesh
8706 001	33 cm	6 x 6 mm
8706 002	33 cm	4 x 4 mm
8706 003	33 cm	2 x 2 mm
8706 005	36 cm	4 x 4 mm

Trade Pack 5 Pieces







Maggot Box

Bait Box

### Black Magic® Maggot Box

Modern bait box in practical format. With a perforated lid for live baits such as maggots or worms.

Code	Content	Contents
8172 015	1 pcs	0,75 l
Trade Pack 10 Pieces		

### Black Magic® Bait Box

Modern bait box in practical format. With a sealed lid, e.g. for damp pellets.

Code	Model	Content	Contents
8172 016	Particle	1 pcs	0,75 l
8172 017	Groundbait	1 pcs	3,00 l
Trade Pack 10 Pieces			



### 4 Blade Worm Scissors

After the success of our worm chopper we have added to our range worm scissors equipped with four cutting blades. The perfect tool for chopping larger quantities of worms for loose feeding.

Code
6531 002
Trade Pack 5 Pieces



### Groundbait Whisk

Optimised design. Reaches into the tightest corners of the mixing bowl. With 8 mm shaft, fitting into common akku drills.

Code	Height	Depth
6501 003	30 cm	14 cm



### Bait Boxes

Code	Contents
8172 001	0,6 l
Trade Pack 10 Pieces	



### Bait Box

Code	Contents
8172 002	1,25 l
Trade Pack 10 Pieces	



### Bait Box

Code	Contents
8172 003	2,50 l
Trade Pack 10 Pieces	



### Bait Box

Code	Contents
8172 005	1,00 l
Trade Pack 10 Pieces	



### Bait Box

Code	Contents
8172 006	1,50 l
Trade Pack 10 Pieces	

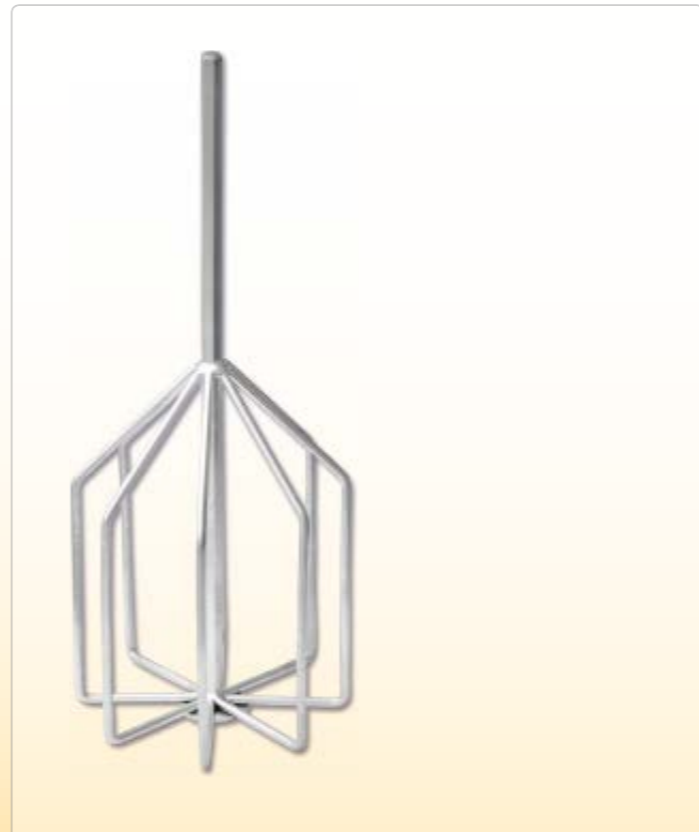

### Bait Mixer

Innovative groundbait stirrer that particularly comes into its own with large volumes of groundbait.

Code	Height	Depth
6501 004	29 cm	12 cm



### Sickle

Clearing sickle with saw-blade cutter for clearing the peg of weed and reed stems. Screws onto a landing net handle.

Code	Length
6327 003	15 cm
Trade Pack 5 Pieces	





### Distance Master

A line measuring device that guarantees accurate distance casting every time, especially when multiple rods are set-up to fish the same distance. Much easier and more accurate than counting reel turns or pacing line out along the bank! The set includes poles with line protecting bobbins and a measuring cord.

Code	Length	Content
8204 004	70 cm	1 pcs



### Pole Roosts

Burgundy EVA roost. With 6 supports.

Code
8203 021
Trade Pack 5 Pieces



Delivered in pairs.

### Kit roost 12 rods

Supplied in pair with the front roost in a thinner diameter than the rear. Roost with three screw threads for secure fixing in the ground.

Code
8203 011
Trade Pack 5 Pieces



### Feeder Rod Rest, deluxe

Code	Model
8202 018	Deluxe
Trade Pack 5 Pieces	



### Feeder Rod Rest

Code	Length
8203 012	32 cm
Trade Pack 5 Pieces	



### Feeder Rod Rest

Code	Length
8203 013	35 cm
Trade Pack 5 Pieces	



V-Shaped upper edge

### Pole Catcher

Small net for protecting pole sections. V-shaped leading edge allows a pole to be placed in from above without rolling out.

Code
8201 010
Trade Pack 5 Pieces



### Tripod, tough

Highly robust tripod. Stands extremely firm in all kinds of weather.

Code	Height	Weight
8201 017	55 - 95 cm	1,5 kg



### Tripod

On hard, uneven ground a tripod is your best bet for mounting rod rests. Extendable in three places with hook for hanging stabiliser weights. 48cm - 108cm.

Code	Height	Weight
8201 008	42 - 88 cm	1,3 kg



### Flat Bed Pole Roller

A traditional and popular design of flat bed roller. The 2 roller sections provide a wide „target“ area and effectively act as 2 rollers if breaking a pole down twice. Good quality, light in weight but very stable due to the roller width and wide angled telescopic legs. Supplied in carry bag.

Code	Width	Height	Weight
8201 027	56 cm	50 - 80 cm	1,57 kg



### W Pole Roller

A new style of flat bed roller combining the best aspects of flat and V rollers. The unique W shape always moves the pole gently over to the side roller when shipping back. This eliminates the section breaking danger of poles being blown across and out of the flat roller in windy condition. The 2 roller sections provide a wide „target“ area and effectively act as 2 rollers if breaking a pole down twice. Has telescopic folding legs and is supplied with carry bag.

Code	Width	Height	Weight
8201 026	56 cm	50 - 80 cm	1,57 kg





### Black Magic® Rod Carrier, medium

Padded protective rod carriers with a full zip opening and pouch large enough for larger reels. Fitted with padded shoulder strap and carry handle. 2 sizes for different section lengths. Material: 100% Nylon

Code	Length	Width	Height
8527 009	150 cm	18 cm	8 cm



### Black Magic® Rod Carrier, long

Padded protective rod carriers with a full zip opening and pouch large enough for larger reels. Fitted with padded shoulder strap and carry handle. 2 sizes for different section lengths. Material: 100% Nylon

Code	Length	Width	Height
8527 016	170 cm	8 cm	18 cm



### Black Magic® Large Foldaway Bowl

Material: 100% Nylon

Code	Ø
8527 010	35 cm

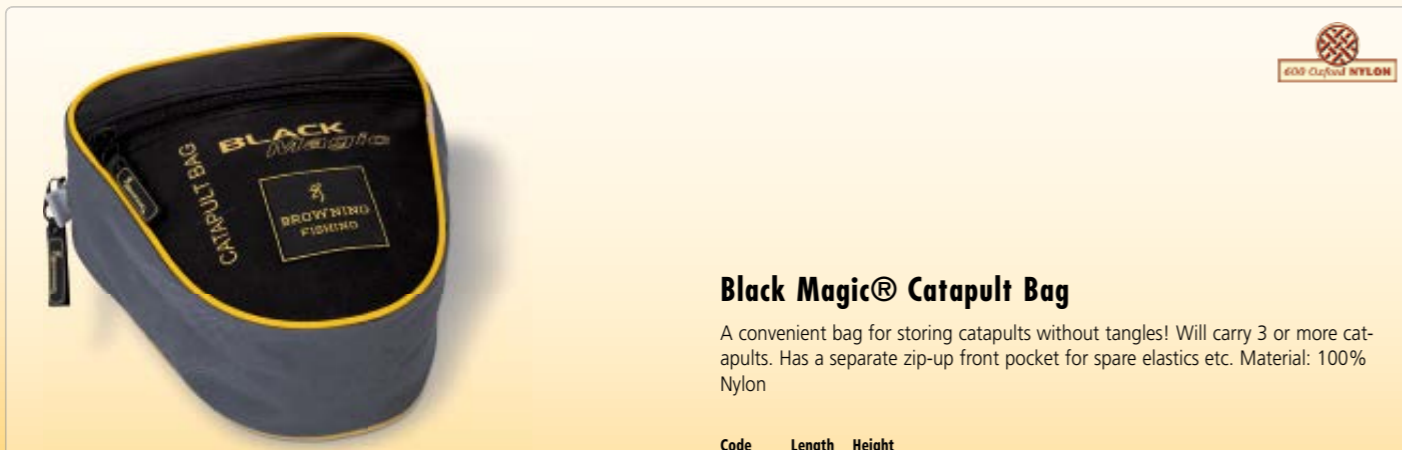

### Black Magic® Catapult Bag

A convenient bag for storing catapults without tangles! Will carry 3 or more catapults. Has a separate zip-up front pocket for spare elastics etc. Material: 100% Nylon

Code	Length	Height
8527 011	25 cm	8 cm



### Black Magic® Cool Bag

High quality, fully padded and foil lined cool bag. Essential for keeping bait fresh in warmer weather. Good for food & drink also ! Material: 100% Nylon

Code	Length	Width	Height
8527 012	30 cm	18 cm	20 cm



### Black Magic® Deluxe Tackle Bag

High quality, multi-purpose, tackle bag. The main compartment is padded, and the lid is semi-rigid for full protection. Has three spacious external zip pockets, carry handles and a padded shoulder strap. Material: 100% Nylon

Code	Length	Width	Height
8527 013	40 cm	27 cm	30 cm



### Compact Rod Holdall

A compact rod/pole bag for anglers who like to carry less tackle. Will take 3 large tubes, so plenty of space for rods and/or a short pole. Has a long front pocket for an umbrella or banksticks etc., padded shoulder strap and carry handle. Material: 100% Nylon

Code	Length	Width	Height
8527 015	175 cm	11 cm	8 cm







### Black Magic® Match Holdall

A conveniently sized pole/rod holdall big enough for most anglers' needs. The large single compartment will carry 6+ large rod tubes with ease and has two separate front pockets for an umbrella plus banksticks etc. Rubberised base, comfortable padded carry handles and strap. Material: 70% Polychlorid, 30% Polyester

Code	Length	Tubes/ Capacity
8527 001	1,85 cm	6-8



### Black Magic® Compact Holdall

Ideal for the angler who wants, or needs, to carry less. All the same useful features as the Medium holdall but slightly narrower to take 4+ large tubes. Two front pockets will carry an umbrella plus banksticks etc. Rubberised base, comfortable padded carry handles and strap. Material: 70% Polychlorid, 30% Polyester

Code	Length	Tubes/ Capacity
8527 002	1,85 cm	4-6



### Black Magic® Unhooking Mat/Cushion

Waterproof and fish-friendly unhooking mat with practical dimensions. Folds away, with the help of clips, into a practical, waterproof cushion for the seat box or for sitting directly on the bank. Material: 100% Nylon

Code	Length	Width	Content
8517 042	75 cm	45 cm	1 pcs



### Black Magic® Compact Carryall

All the same features as the medium carryall but with the main compartment dimensions scaled down 25% to make a compact, easy to carry bag. Perfect for those who prefer a smaller bag or carry less. Material: 70% Polychlorid, 30% Polyester

Code	Length	Width	Height
8527 004	40 cm	50 cm	20 cm



### Black Magic® Compact Net Carrier

Identical design to the Multi Net Carrier bag but with a single zip-up main keep-net compartment plus separate front pocket with clipped flap for net heads, weigh sling or unhooking mat etc.. Material: 70% Polychlorid, 30% Polyester

Code	Length	Width	Height
8527 005	55 cm	47 cm	10 cm



### Black Magic® Multi Net Carrier

Traditional style carry bag for nets in a durable material with rubberised base to resist wear. Two large zip-up main compartments for multiple keepnets, plus a useful separate front pocket, with clipped flap for landing net heads, weigh sling or unhooking mat etc. Material: 70% Polychlorid, 30% Polyester

Code	Length	Width	Height
8527 006	55 cm	47 cm	19 cm





**Black Magic®  
Foldaway Bowl**

The perfect size and depth for mixing up to 1kg groundbait. Folds flat so easy to carry. Material: 70% Polychlorid, 30% Polyester

Code	Ø
8527 008	25 cm



**Black Magic® Accessory/Reel Bag**

A multi-purpose zip top bag with 1001 uses. Has moveable internal partitions, so can be adapted for a variety of uses. Large enough for 2 reels or 1 reel plus multiple spare spools. Material: 70% Polychlorid, 30% Polyester

Code	Length	Height	Depth
8527 007	26 cm	15 cm	10 cm



**Xitan Advance Mega Multi-pocket Pole Holdall**

Professional quality holdall as supplied with Browning's top-end poles. Designed slightly oversized so carries large tubes without straining zips and seams. Padded heavy-duty waterproof outer for total protection for rods & poles, plus a rubber reinforced base and strong zips. Has 1 long front pocket for net handles etc, plus 2 shorter pockets for mini-extensions and a side quiver for an umbrella. The Mega version will carry 12 large tubes in two compartments and is the perfect size for the angler who carries everything! Material: Bag material: 30% Polyester, 70% Polychlorid. Filling material: EPE. Lining material: 100% Polyester.

Code	Length	Tubes/ Capacity
8528 001	1,90 m	12



**Xitan Advance Large Multi-pocket Pole Holdall**

Professional quality holdall as supplied with Browning's top-end poles. Designed slightly oversized so carries large tubes without straining zips and seams. Padded heavy-duty waterproof outer for total protection for rods & poles, plus a rubber reinforced base and strong zips. Has 1 long front pocket for net handles etc, plus 2 shorter pockets for mini-extensions and a side quiver for an umbrella. This version will carry 6-8 large tubes in a single compartment and is the perfect size for most anglers. Material: Bag material: 30% Polyester, 70% Polychlorid. Filling material: EPE. Lining material: 100% Polyester.

Code	Length	Tubes/ Capacity
8528 003	1,90 m	6+



**Xitan Pole Rig and Winder Bag**

This practical bag stores pole rigs neatly and protects them reliably during transport to the water. The little storage miracle provides sliding compartments in the front to take 6 winder trays and a storage compartment in the cover area with space for rig accessories or 2 additional winder trays, taking the storage capacity to a maximum of 104 winders. A useful aid for finding a wide variety of rigs in no time at all at the water's edge. Contents not included. Material: 100% Nylon

Code	Length	Width	Height
8526 030	28 cm	20 cm	21 cm



**Xitan Mega Competition Pole Holdall**

Smart rod/pole holdalls. Each has been made slightly oversized, so zips are not strained if used with large tubes, and feature a single large and deep front pocket with long zip that will carry long and bulky accessories. A side quiver allows an umbrella to be carried outside the main holdall. The holdalls have a rubber reinforced base to resist wear. This holdall will actually carry more than 12 tubes. The 12 tube "Mega Holdall" has 2 compartments, both with full zips. It has a huge capacity and is the perfect choice for the angler that likes to carry absolutely everything! Material: 70% Polychlorid, 30% Polyester

Code	Length	Tubes/ Capacity
8526 002	1,85 m	12
8526 005	2,05 m	12



**Xitan Protecta Rigid Pole Holdall**

A new design of pole holdall that organizes and provides total protection for your pole, top kits and spare sections. The holdall has space for 3 large tubes for the main pole in one compartment. A second compartment has 8 small square tubes that can each store 2 x 2/1 top kits and also a larger square tube for spare sections. The long front pocket is for mini-extensions, net handles etc and has a lower zip opening to give access to short items. Zip flap top opening with shoulder strap and carry handle. Material: 100% Nylon

Code	Length	Tubes/ Capacity
8526 029	190 cm	3





## Xitan Large Competition Pole Holdall

Smart rod/pole holdalls. Each has been made slightly oversized, so zips are not strained if used with large tubes, and feature a single large and deep front pocket with long zip that will carry long and bulky accessories. A side quiver allows an umbrella to be carried outside the main holdall. The holdalls have a rubber reinforced base to resist wear. The 6 tube has a single compartment with full length heavy duty zip. This holdall will actually carry more than 6 tubes and is a good choice for the typical angler. Material: 70% Polychlorid, 30% Polyester

Code	Length	Tubes/ Capacity
8526 001	1,85 m	6
8526 004	2,05 m	6



## Xitan Large Competition Rod Carrier

The ultimate match holdall: The Combo Rod Holdall holds up to 6 rigged up rods (two per section) and all accessories. The rod sections are upholstered and offer 100% protection for your tackle. The shoulder straps are attached to the holdall in such a way that the holdall moulds to the back perfectly when carrying. Material: 70% Polychlorid, 30% Polyester

Code	Length	Compartments
8526 003	1,65 m	3



## Xitan In-Line

Very rigid, hardcase rod carriers that will completely protect made-up rods. The oversized reel pouches will accommodate large reels, but also allow multiple rods to be stored "in-line" – a much more compact solution than wide traditional multi-rod carriers. The carriers have full-length zips for easy access. The small size takes up to 2 rods, the large size up to 3 rods. Material: 70% Polychlorid, 30% Polyester

Code	Length	Tubes/ Capacity
8526 008	1,80 m	2
8526 006	1,80 m	3



## Xitan Stiffy Single Rod Carrier

A light hardcase carrier for made-up rods. Instead of full length zips, which can damage or cut the line, these rodcases feature a zip-flap arrangement. The rods are simply slid into a protection tube, then a flap with a built in reel pouch is closed over the reel and zipped up. 100% protection for rod, reel and line. Complete with carry strap. Material: 70% Polychlorid, 30% Polyester

Code	Length	Tubes/ Capacity
8526 022	1,55 m	1



## Xitan Hardshell Multirod Carrier

Complete protection for made-up rods in this zip-up semi-rigid case. Each bag will carry 2 rods with reels "end-to-end". In 3 sizes to suit different section lengths sizes including a special short case for our Commercial King Wands and Micro Wagglers. Material: 100% Polyester

Code	Model	Length	Width
8526 025	mini	140 cm	17 cm
8526 026	medium	165 cm	17 cm
8526 027	long	180 cm	17 cm

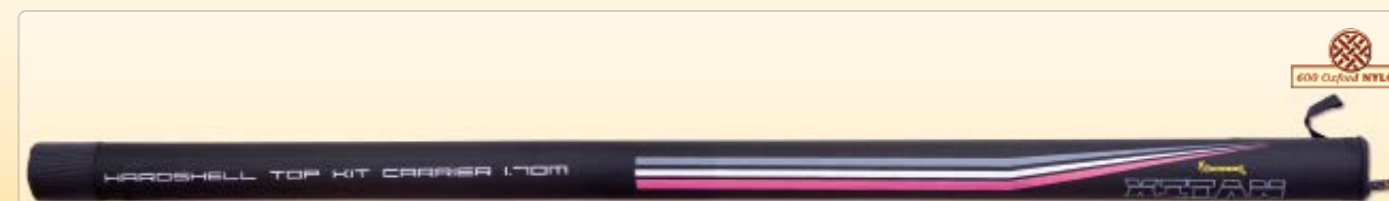

## Xitan Hardshell Top Kit Carrier

Complete protection for pole top kits in this zip-up and padded semi-rigid case. Material: 100% Nylon

Code	Length	Ø
8526 028	170 cm	8 cm





**NEW**

### Xitan Compact Pole Holdall

A compact and efficient pole holdall for anglers who do not need or want oversized bags. The capacity of around 6 large tubes is enough for pole and plenty of topkits and extra sections. Large flap top opening with a lower second zip opening to give access to shorter items. Top quality wipe clean, rip proof, material with protected base layer. Material: Nylon

Code	Length	Width	Height
8535 001	190 cm	25 cm	20 cm



**NEW**

### Xitan Advance Protecta Holdall X-Long

A new design of pole holdall that organises and provides total protection for you pole, topkits and spare sections. The holdall has space for 3 large pole tubes in one compartment. A second compartment has 10 smaller square tubes to store multiple topkits, plus a larger tube for spare sections etc. There is also a full length third front compartment with an extra lower zip opening. This X-Long version of the Protector holdall is designed for poles with longer butt sections – like Browning's Z10/12/14 & 16 and the topkit tubes are the full length of the bag so will accommodate long 1 piece kits etc. Material: Nylon

Code	Length	Width	Height
8536 001	205 cm	25 cm	20 cm



### Xitan Advance Protecta Holdall

A safe and convenient way to store and transport pole topkits. The holdall contains 8 completely rigid square tubes for kits, plus one larger square tube which can be used to hold other spares like middle sections etc. The kit tubes are large enough to each hold 2 typical sized topkits if they are stored "end-to-end". Durable wipe-clean outer with zipped flap top for easy access. Material: 100% Nylon

Code	Length	Width	Height
8537 001	1,50 m	20 cm	20 cm

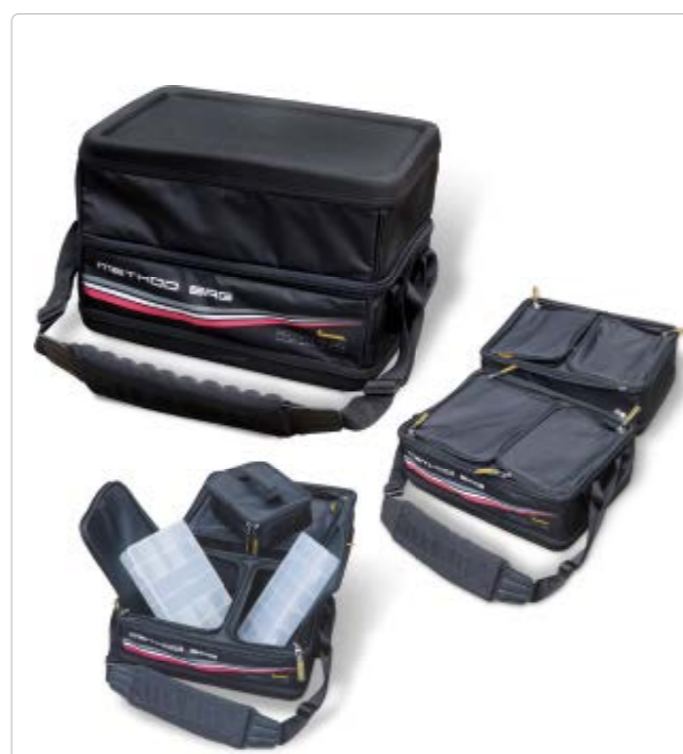

### Xitan Method Bag

Practical bag particularly suited to the requirements of method feeder anglers. Includes 2 plastic boxes plus 2 internal pockets. A total of 4 compartments. Top and bottom in robust material. Material: 100% Polyester

Code	Length	Width	Height
8526 015	40 cm	30 cm	30 cm



**NEW**

### Black Magic® Keep Net Bag

A practical and convenient waterproof keepnet bag. Will carry up to 2 keepnets and a net head. Very durable easy-clean plastic outer with sealed seams. Protect your car and your nets! Material: 210D PVC

Code	Length	Width	Height
8445 001	60 cm	55 cm	5 cm



**NEW**

### Xitan Modular Accessory Bag

The Xitan Modular luggage is available in a range of compatible sizes designed so that the smaller bags can be stacked perfectly inside the larger carryalls. The Xitan Modular Accessory bags are available in a range of sizes to suit different items of tackle. Top quality wipe clean, rip proof, material with protected base layer. Material: 70% Polychlorid, 30% Polyester

Code	Model	Length	Width	Height
8570 001	L	54 cm	18 cm	22 cm
8570 002	M	27 cm	18 cm	11 cm



**NEW**

### Xitan Modular Accessory Bag

The Xitan Modular luggage is available in a range of compatible sizes designed so that the smaller bags can be stacked perfectly inside the larger carryalls. The Xitan Modular Accessory bags are available in a range of sizes to suit different items of tackle. Top quality wipe clean, rip proof, material with protected base layer. Material: 70% Polychlorid, 30% Polyester

Code	Model	Length	Width	Height
8570 003	S	13 cm	18 cm	8 cm





**NEW**

### Xitan Modular Cool Bag

The Xitan Modular luggage is available in a range of compatible sizes designed so that the smaller bags can be stacked perfectly inside the larger carryalls. The coolbag is heavily padded and foil lined for maximum insulation. Will accommodate 6 large baitboxes. Top quality wipe clean, rip proof, material with protected base layer. Material: 70% Polychlorid, 30% Polyester

Code	Length	Width	Height
8570 006	54 cm	18 cm	22 cm



**NEW**

### Xitan Leg/Roller Bag

Extra long and large, full zip, bag intended for pole rollers, seatbox/platform legs, or any other long bulky items. Top quality tough, wipe clean material with protected base layer. Material: 70% Polychlorid, 30% Polyester

Code	Length	Width	Height
8571 001	110 cm	25 cm	30 cm

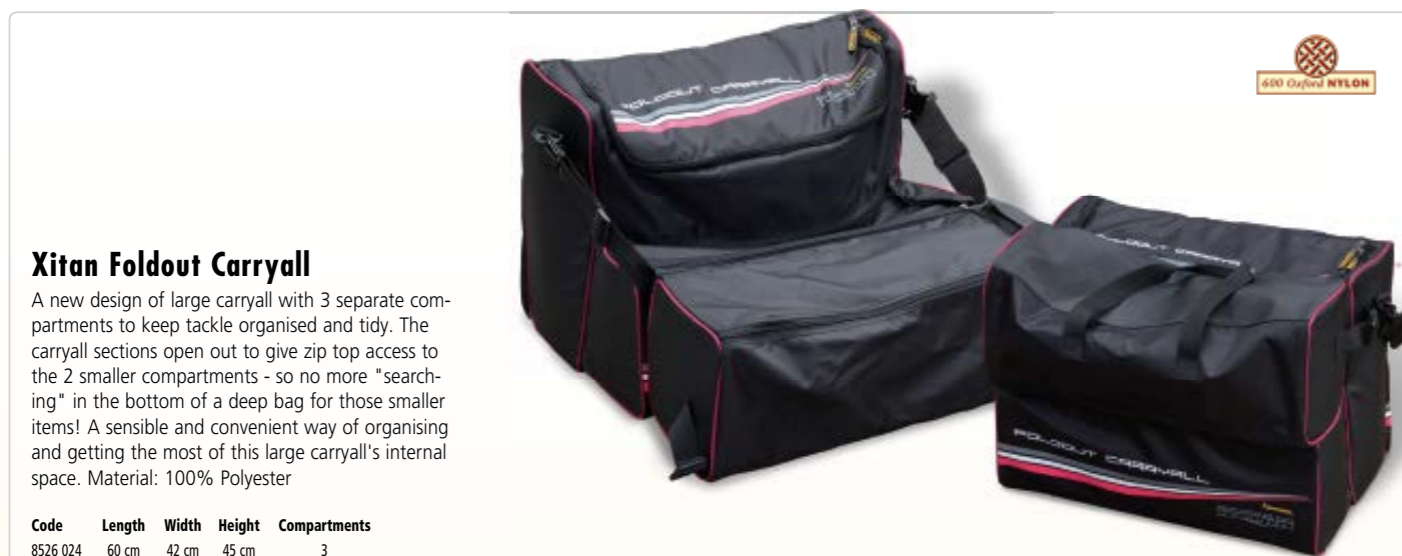

400 Oxford NYLON

### Xitan Foldout Carryall

A new design of large carryall with 3 separate compartments to keep tackle organised and tidy. The carryall sections open out to give zip top access to the 2 smaller compartments - so no more "searching" in the bottom of a deep bag for those smaller items! A sensible and convenient way of organising and getting the most of this large carryall's internal space. Material: 100% Polyester

Code	Length	Width	Height	Compartments
8526 024	60 cm	42 cm	45 cm	3



**NEW**

400 Oxford NYLON

### Xitan Feeder Tip Bag

Total protection for delicate quivertips. The tip bag contains a series of completely rigid, full length, PVC tubes allowing tips to be store separately, so protecting guides and thin tips. Durable wipe-clean outer with zippered flap top for easy access. Material: Nylon

Code	Length	Width	Height	Tubes/ Capacity
8570 007	75 cm	10 cm	3 cm	12



400 Oxford NYLON

### Xitan Mega Competition Carryall

The Xitan Carryalls have been developed for modern match fishing, where large quantities of equipment are generally carried to the water. The robust material and high quality buckles and fasteners ensure that the bags do not let you down even when filled to the brim. Finished with elegant features such as side handles for easier loading and unloading from the car. XL Model: No match carryall offers more space. With hard base to ensure the carryall always retains its shape. Two side pockets and a large keepnet pocket (e.g. for more than one keepnet) to the front. Material: 70% Polychlorid, 30% Polyester

Code	Length	Height	Depth
8526 009	60 cm	50 cm	45 cm



400 Oxford NYLON

### Xitan Large Competition Carryall

The Xitan Carryalls have been developed for modern match fishing, where large quantities of equipment are generally carried to the water. The robust material and high quality buckles and fasteners ensure that the bags do not let you down even when filled to the brim. Finished with elegant features such as side handles for easier loading and unloading from the car. L Model: Approximately one third smaller, the ultimate carryall for match anglers - neither too small nor too large, for carrying all essential equipment to the water's edge. Also with hard base, two side pockets and a keepnet section. Material: 70% Polychlorid, 30% Polyester

Code	Length	Height	Depth
8526 010	58 cm	43 cm	36 cm



400 Oxford NYLON

### Xitan Medium Match Carryall

Average-sized model with deep front section for storing side trays or several keepnets etc. and two side pockets. Also with carry handles and an adjustable carry strap. Material: 70% Polychlorid, 30% Polyester

Code	Length	Width	Height
8526 011	45 cm	25 cm	55 cm



400 Oxford NYLON

### Xitan Feeder Bag

Large carryall specially designed for feeder anglers. With reinforced bottom, two side pockets, a large front pocket and, of course, a huge main section. Integrated rain protection, large padded carry strap and two handles for lifting out of the car. Material: 70% Polychlorid, 30% Polyester

Code	Length	Width	Height
8526 021	70 cm	30 cm	40 cm





**Xitan Ultra Cool Bait Bag**

Indispensable bag for carrying fresh bait to the water, in any kind of weather. Also useful for storing the angler's food of course... Covered with foil for insulation. Takes up to 6 x 1-l bait boxes. Separate top section for separate storage of bloodworm and joker. Material: 70% Polychlorid, 30% Polyester

Code	Length	Height	Depth
8526 013	38 cm	30 cm	26 cm

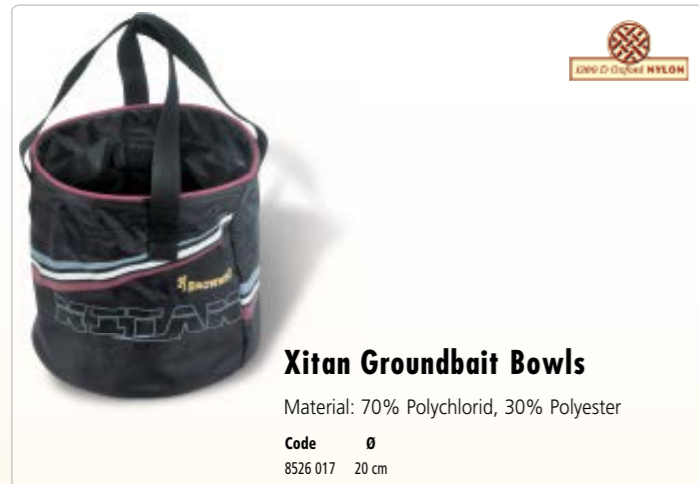

**Xitan Groundbait Bowls**

Material: 70% Polychlorid, 30% Polyester

Code	Ø
8526 017	20 cm

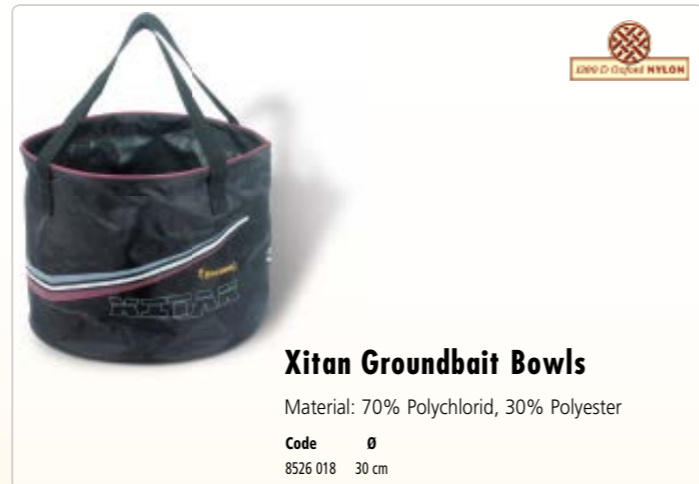

**Xitan Groundbait Bowls**

Material: 70% Polychlorid, 30% Polyester

Code	Ø
8526 018	30 cm

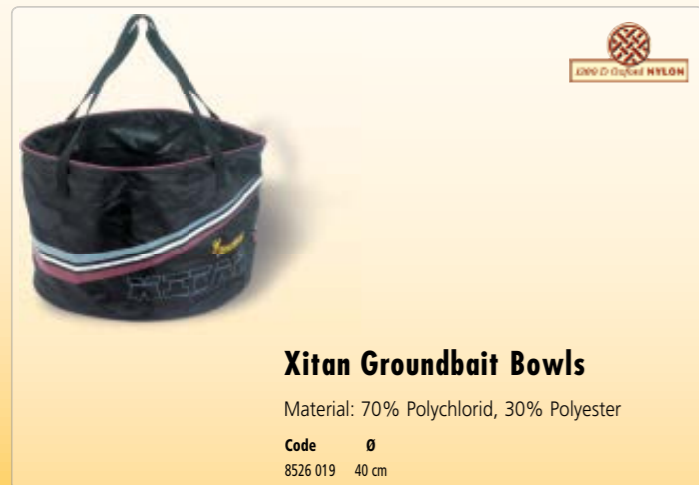

**Xitan Groundbait Bowls**

Material: 70% Polychlorid, 30% Polyester

Code	Ø
8526 019	40 cm



**Xitan Accessory & Reel Bag**

For storing reels, spare spools, forceps, feeders, catapults etc... The applications are endless for this handy transport accessory. With allround zip fastener. Material: 70% Polychlorid, 30% Polyester

Code	Width	Height
8526 016	19 cm	10 cm



**Xitan Rod Protector Sleeve**

A very effective and low cost alternative for protecting made-up rods in transit. Each pack contains 2 long padded sleeves that are secured with neoprene straps and velcro. No other straps needed ! 2 pieces per pack. Material: Polychlorid

Code
8518 030

Trade Pack 5 Pieces



**Rod Protector**

Inflatable protector for rods during transport, e.g. for Bolognese rods. Material: Polychlorid

Code
8517 040

Trade Pack 5 Pieces



**Rod Velcro Fastener**

Stretchy neoprene straps with a long velcro section. A set of two straps in each pack. Material: Neoprene

Code
8523 018

Trade Pack 10 Pieces



**Xitan Keepnet Bag waterproof**

A totally waterproof way of transporting wet nets. Our bags are made from top quality nylon that resists premature wear and cracking – not to be confused with cheaper products on the market. Material: 30% Polyester, 70% Polychlorid

Code	Length	Width	Height
8406 001	55 cm	15 cm	55 cm
8406 002	55 cm	30 cm	55 cm



**Xitan Bait Box Set**

Large, waterproof storage bag for organising baits on a side tray. With three small and one medium-sized individual boxes. Easy to wash thanks to the material. Material: 30% Polyester, 70% Polychlorid

Code	Model	Length	Width	Height	Content
8400 040	5 pcs waterproof	27,5 cm	33,5 cm	8 cm	1 pcs



**Xitan Groundbait Box Set**

Large, waterproof storage bag for transporting groundbait. With two large individual boxes. Easy to rinse thanks to the material. Material: 30% Polyester, 70% Polychlorid

Code	Model	Length	Width	Height	Content
8400 041	3 pcs waterproof	27,5 cm	33,5 cm	8 cm	1 pcs





Fits both 25 & 36mm diameter seatbox legs.

### Xitan Groundbait Holder

Groundbait bowl with holder for attachment to a seat box. Easy to clean thanks to the waterproof and wipe-clean material. Material: 30% Polyester, 70% Polychlorid

Code	Model	Ø	Height	Content
8400 042	round, waterproof	25 cm	15 cm	1 pcs



Fits both 25 & 36mm diameter seatbox legs.

### Xitan Groundbait Holder

Square groundbait bowl with holder for attachment to a seat box or platform. Easy to clean thanks to the waterproof and wipe-clean material. Material: 30% Polyester, 70% Polychlorid

Code	Model	Length	Width	Content
8400 043	rectangular, waterproof	20 cm	30 cm	1 pcs

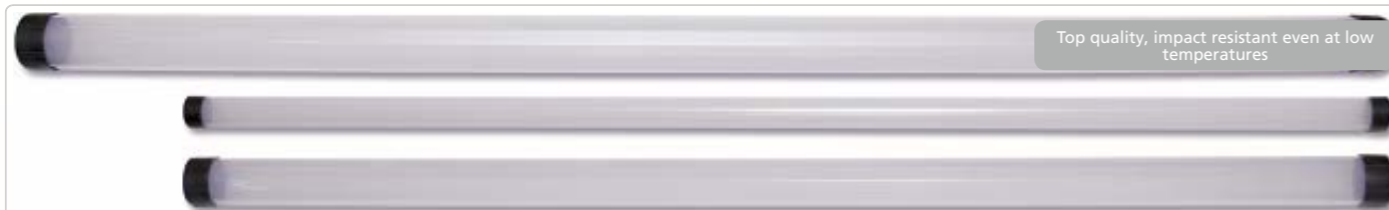

Top quality, impact resistant even at low temperatures

### Premium quality protective tubes

These top-quality tubes resist both cracking in low temperatures and distortion in high temperatures. Your valuable poles and rods deserve the best protection available.

Code	Length	Ø
8510 010	2,05 m	6 cm
8510 011	1,60 m	4 cm
8510 012	1,60 m	6 cm

Trade Pack 5 Pieces



### Xitan Fibre Framed Match Umbrella

Sometimes the heavens open. But with Browning umbrellas, you can stay dry in the fiercest downpours. This large umbrella with a diameter of 2.5 m is of conventional design and impresses with its lightweight yet indestructible fibreglass frame. Material: 100% Nylon

Code	Ø
9977 001	2,50 m



### Xitan Mega Match umbrella

Umbrellas are also indispensable for match anglers. Yet some are not large or robust enough to offer the angler the adequate protection. The Xitan Mega Match fishing umbrella fulfils these requirements perfectly. Nubrollie system, 3 m diameter, 420D nylon, PU-coated, sealed seams, stainless steel shaft and ground spike. Material: 100% Nylon

Code	Ø
9978 001	3,00 m





STAINLESS STEEL

## Umbrella, Browning

Sometimes the heavens open. But with Browning umbrellas, you can stay dry in the fiercest downpours. The large, burgundy umbrella in conventional design has undergone a further PVC coating and reinforcement since previous years.

Code	Ø	Tr.-Length
9972 250	2,50 m	1,35 m



NEW

## Xitan Carp X-Strong Keep Net

Top quality keepnet for big catches. Tough carp mesh throughout with external metal rings which eliminate wear at the corners.

Code	Length	Width	Height	Mesh
7014 001	2,50 m	40 cm	50 cm	2 x 2 mm
7014 002	3,00 m	40 cm	50 cm	2 x 2 mm
7014 003	3,50 m	40 cm	50 cm	2 x 2 mm



NEW

## Black Magic® Standard Keep Net

Black Magic quality keepnet in 4 lengths. Open 6mm mesh with carp mesh bottom sections. Strong protected rings, Metal top ring with angle lock. Compact when folded, dries quickly.

Code	Length	Width	Height	Mesh
7015 001	2,50 m	40 cm	50 cm	6 x 6 mm
7015 002	3,00 m	40 cm	50 cm	6 x 6 mm
7015 003	3,50 m	40 cm	50 cm	6 x 6 mm



NEW

## Black Magic® Standard Carp Net

Black Magic quality keepnet. Strong non-snap carp mesh through all sections. Strong protected rings, Metal top ring with angle lock. Perfect for big catches.

Code	Length	Width	Height
7016 001	3,00 m	40 cm	50 cm



NEW

## Xitan Silverfish X-Strong Keep Net

Top quality silverfish keepnet. A more compact partner version of the Xitan X-Strong carp keepnet. Tough mesh throughout with external metal rings which eliminate wear at the corners. Top ring fitted with an ultra strong 1 piece screw fitting with no moving parts to fail.

Code	Length	Width	Height	Mesh
7050 001	2,50 m	40 cm	50 cm	2 x 2 mm



NEW

## King Feeder Quick Dry Net

Keep-net with a particularly quick drying mesh material. Fully coated metal rings.

Code	Length	Width	Height	Mesh
7062 001	4,00 m	50 cm	40 cm	6 x 6 mm



## Rubber Mesh Keepnet

By popular demand, keepnets with rubber-coated net material. Optimum protection for fish combined with almost instant drying. Also extremely wear resistant and long lasting.

Code	Length	Ø	Mesh
7041 350	3,50 m	50 cm	6 x 6 mm
7041 400	4,00 m	50 cm	6 x 6 mm



## Starter Keepnet

Value for money circular keepnet in extremely quick drying material. Ideal for beginners. Length up to 5m.

Code	Length	Ø	Mesh
7005 200	2,00 m	50 cm	4 x 4 mm
7005 250	2,50 m	50 cm	4 x 4 mm
7005 300	3,00 m	50 cm	4 x 4 mm
7005 350	3,50 m	50 cm	4 x 4 mm
7005 400	4,00 m	50 cm	4 x 4 mm





## Black Magic® Space Saver Keep Net

Designed to be compact, quick to dry and easy to carry. These strong, durable keepnets are fish friendly with open mesh middle and carp mesh bottom section. The covered and solid metal bottom rings ensure that the net sinks quickly without the need for extra weights. Fitted with a new design of strong screw fitting which has no moving parts to fail. Excellent value and available in 3 popular sizes.

Code	Length	Width	Height
7011 250	2,50 m	50 cm	40 cm
7011 300	3,00 m	50 cm	40 cm
7011 400	4,00 m	50 cm	50 cm



## Keepnet Weight

Screws externally to a keepnet ring. Surely the simplest method to weight a keepnet without endangering the fish in the net.

Code	Weight
6069 200	200 g

Trade Pack 5 Pieces



## Black Magic® Power Multi-length Handle

An ultra strong and very stiff full carbon 4m handle. Made in 4 pieces, it has a short threaded section that can be removed to place fish in the keepnet, plus a 1m long extension section which allows the handle to be used at either 3 or 4 meters. The thread fitting has a brass insert set into a stainless steel outer, through riveted to the handle, for 100% reliability.

Code	Length	Weight	Sections	Tr.-Length
7180 400	4,00 m	540 g	4	1,50 m



## Black Magic® Ultra Power Handle

In the Black Magic tradition, this 2 piece, take apart, handle is made of a special reinforced carbon mix to be ultra strong and ultra stiff, yet still light in weight. The strongest handle we have ever made.

Code	Length	Weight	Material	Sections	Tr.-Length
7179 270	2,70 m	318 g	Carbon	2	1,47 m



## Pit Bull Tele Pro Tele Net Handle

A simple, strong and durable telescopic net handle. Excellent value.

Code	Length	Weight	Material	Sections	Tr.-Length
7177 200	2,00 m	196 g	Glass fibre	2	1,15 m
7177 250	2,50 m	276 g	Glass fibre	3	1,15 m
7177 300	3,00 m	313 g	Glass fibre	3	1,15 m



## Commando Power Net Handle

Robust landing net handle that impresses with its outstanding price-performance ratio.

Code	Length	Weight	Material	Sections	Tr.-Length
7178 200	2,00 m	220 g	Glass fibre	2	1,14 m
7178 300	3,00 m	357 g	Glass fibre	3	1,15 m
7178 400	4,00 m	512 g	Glass fibre	4	1,15 m



## Xitan Strong 'n Long LNH

A top-quality long landing net handle. The handle is light in weight, but has been made stronger than typical long handles. A good choice for anglers who want a handle with extra strength and improved reliability.

Code	Length	Weight	Material	Sections	Tr.-Length
7104 500	5,00 m	440 g	Carbon	4	1,35 m



## Black Magic® T/A Power Handle

A Black Magic strength and quality, full carbon 3m landing net handle. Perfect for any situation or purpose. Light, stiff and strong with secure brass fitting. Will give years of reliable service.

Code	Length	Weight	Sections	Tr.-Length
7110 330	3,3 m	290 g	3	1,24 m
7110 440	4,4 m	460 g	4	1,24 m





**NEW**



### Xitan Ultra Stiff Handle

A special design of landing net handle for bigger fish and catches. The large diameter top section makes the handle extremely stiff so will not bend under load. - makes "scooping" fish quick and easy. 2.8m, 2 piece, take-apart, high quality carbon so very light in weight, and fitted with a special brass screw fitting. Also available as the 3 piece, Xitan Duo-length with an additional top section extending the handle to 4m

Code	Length	Weight	Sections	Tr.-Length
7115 280	2,80 m	250 g	2	1,51 m

**NEW**



### Xitan Ultra Stiff Duo-Length

A special design of landing net handle for bigger fish and catches. Can be used as an extremely stiff, 2 piece, 2.8m handle that does not bend under load, or fitted with the supplied extra top section to extend the handle to a full 4m, without significantly affecting stiffness. High quality carbon so very light in weight and fitted with secure brass screw fittings on 2 sections.

Code	Length	Weight	Sections	Tr.-Length
7115 400	4,00 m	420 g	3	1,51 m



### Black Magic® Quick Dry

Code	Length	Width	Depth	Mesh
7017 001	55 cm	45 cm	38 cm	5 x 5 mm



### Black Magic® Camo

Mesh width 2x2mm, bottom 5x5mm

Code	Length	Width	Depth	Mesh
7017 002	55 cm	45 cm	38 cm	2 x 2 mm



### River Scooper

Code	Length	Width	Depth	Mesh
7017 003	55 cm	45 cm	30 cm	20 x 20 mm



### Black Magic® Monyl

Code	Length	Width	Depth	Mesh
7017 004	55 cm	45 cm	25 cm	6 x 6 mm



### Carpa Pro Hair Rig

Code	Length	Width	Depth	Mesh
7017 005	50 cm	45 cm	28 cm	2 x 2 mm



### Carpa Pro Standard

Code	Length	Width	Depth	Mesh
7017 006	50 cm	45 cm	28 cm	6 x 6 mm





### Carpa Pro Speed

Code	Length	Width	Depth	Mesh
7017 007	50 cm	45 cm	28 cm	8 x 8 mm



### Black Magic® Competition Pan

Simple, strong nets with a soft fish friendly mesh. Excellent quality and value.

Code	Length	Width	Mesh
7029 001	55 cm	45 cm	3 x 3 mm



### Landing Net Hypercarp

A net head for big fish. Very strong with a slightly larger frame, but also with a deep mesh than average that will safely engulf the biggest fish without drama. Also good for fishing from high banks when fish can be lost from shallower nets.

Code	Length	Width	Depth	Mesh
7029 049	65 cm	60 cm	40 cm	4 x 4 mm



### Landing Net Power Gold

These perfectly sized, strong, light and good-looking net heads all have metal blocks, brass threads and a D profile frame for total reliability. Available in 2 "Power Carp Gold" sizes.

Code	Length	Width	Depth	Mesh
7029 027	55 cm	45 cm	28 cm	4 x 4 mm
7029 028	60 cm	50 cm	30 cm	6 x 6 mm



### Black Magic® Compact Pan

Simple, strong nets with a soft fish friendly mesh. Excellent quality and value.

Code	Length	Width	Depth	Mesh
7029 050	44 cm	38 cm	24 cm	2 x 2 mm



### Landing Net No-Snag Latex

Landing nets with latex covered mesh. Long lasting, quick drying, kind to fish and resistant to hooks!

Code	Length	Width	Depth	Size	Mesh
7029 042	50 cm	38 cm	28 cm	M	5 x 5 mm
7029 043	60 cm	48 cm	30 cm	L	5 x 5 mm
7029 044	60 cm	48 cm	35 cm	XL	5 x 5 mm



### Landing Net Commercial King

Good quality strong nets with a fashionable round mesh shape. Mixed mesh sizes on bottom and side panels allows the net to be pushed through water easily. Very distinctive gunmetal colour.

Code	Model	Length	Width	Depth	Mesh
7029 046	Carp Scooper	50 cm	40 cm	28 cm	2 x 4 mm



### Carp-Mega Net Head

Code	Length	Width	Depth	Mesh
7029 017	70 cm	65 cm	75 cm	15 x 2 mm



**NEW**



### Hyper Carp Landing Net Head

This net head has been specially designed for larger carp. Every part of the net has been carefully designed for maximum strength. The frame has a strong solid metal block that can also be used as a grip to lift fish. The extra large mesh will not trap water and is shaped to hold carp still.

Code	Width	Height	Depth	Mesh
7029 060	52 cm	60 cm	57 cm	25 x 25 mm

**NEW**



### Black Magic® Folding Net Head Triangular

Black Magic quality landing net which folds to a compact size so easy to carry. Also available in a round shape

Code	Length	Width	Height	Mesh
7060 001	55 cm	55 cm	40 cm	6 x 8 mm

**NEW**



### Black Magic® Folding Net Head Round

Black Magic quality landing net which folds to a compact size so easy to carry. Also available in a triangular shape.

Code	Length	Ø	Depth	Mesh
7061 001	40 cm	50 cm	40 cm	6 x 8 mm



### Xi-Dry Polar Jacket

Guaranteed to keep you warm and dry in the harshest of weather conditions. Fully waterproof and breathable, 12000mm rated, outer with a substantial padded lining which keep warmth in without seriously affecting movement when fishing. A durable and top quality product throughout with detachable hood, storm cuffs and zips plus many other features to give you total and long lasting protection from the elements. Material: 100% Nylon, Polyurethane coated. Gram weight: 280 g/m<sup>2</sup>

Code	Size
8974 002	M
8974 003	L
8974 004	XL
8974 005	XXL
8974 006	XXXL



### Xi-Dry Polar Bib'n Brace

Guaranteed to keep you warm and dry in the harshest of weather conditions. Fully waterproof and breathable, 12000mm rated, outer with a substantial padded lining which keep warmth in without seriously affecting movement when fishing. A durable and top quality product throughout with reinforced knees and seat, storm zips plus many other features to give you total and long lasting protection from the elements. Material: 100% Nylon, Polyurethane coated. Gram weight: 280 g/m<sup>2</sup>

Code	Size
8973 002	M
8973 003	L
8973 004	XL
8973 005	XXL
8973 006	XXXL



Hydrostatic Head 5.000 mm

### Black Magic® Thermal Suit

Black Magic quality 2 piece fishing suit. Waterproof, breathable with full padded lining for insulation. Full length jacket with removable hood and adjustable storm cuffs. Bib & Brace style padded overtrousers with adjustable straps and large boot opening. Guaranteed to keep you warm and dry whatever the weather conditions. Material: 100% Polyester, with PU coating.. Gram weight: 180 g/m<sup>2</sup>

Code	Size
8982 002	M
8982 003	L
8982 004	XL
8982 005	XXL
8982 006	XXXL

**NEW**



10.000 mm water resistance

### Xi-Dry WR 10 Jacket

Well tailored, waterproof jacket for the demanding coarse angler. The breathable material properties prevent sweating and subsequent cooling. Material: 100% Nylon, Polyurethane coated. Gram weight: 140 g/m<sup>2</sup>

Code	Size
8916 002	M
8916 003	L
8916 004	XL
8916 005	XXL
8916 006	XXXL





### Xi-Dry Fleece Jacket

Triple-layer, high-performance fleece. Wind and showerproof. The jacket has wipeable nylon layers on the sleeves as well as additional layers in the lower front area for keeping groundbait, fish slime, etc. away from the fleece material. The rear section has a lower cut to protect the back when sitting. Material: 100% Polyester. Gram weight: 390 g/m<sup>2</sup>

Code	Size
8919 002	M
8919 003	L
8919 004	XL
8919 005	XXL
8919 006	XXXL

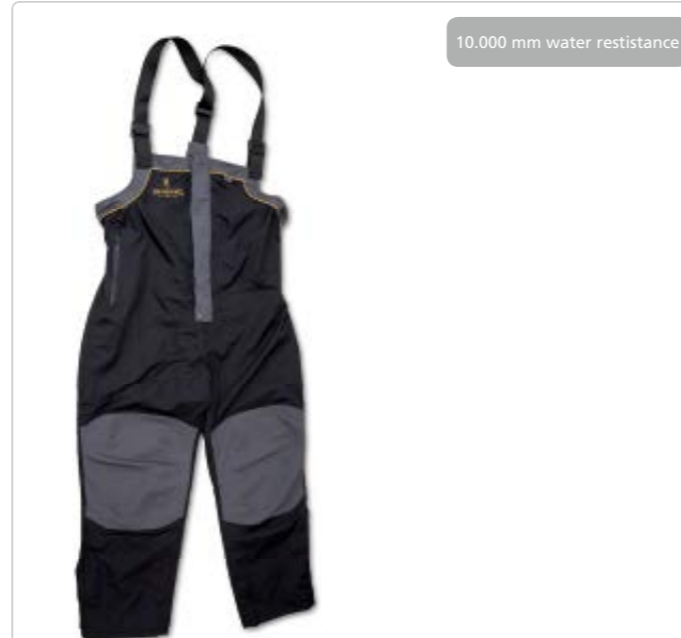

10.000 mm water resistance

### Xi-Dry WR 10 Bib'n Brace

Well tailored, waterproof jacket for the demanding coarse angler. The breathable material properties prevent sweating and subsequent cooling. Material: 100% Nylon, Polyurethane coated. Gram weight: 140 g/m<sup>2</sup>

Code	Size
8917 002	M
8917 003	L
8917 004	XL
8917 005	XXL
8917 006	XXXL



### Dryfit Shirt

Classic Dryfit polo shirt in a design matching the Xi-Dry clothing range. Quick-drying material that guarantees comfortable wearing, particularly in the warm season. Material: 100% Nylon (Dry Fit fabric). Gram weight: 180 g/m<sup>2</sup>

Code	Size
8915 002	M
8915 003	L
8915 004	XL
8915 005	XXL
8915 006	XXXL



### Black Magic® Rain Suit

2 piece, lightweight waterproof and windproof suit. Folds very small so ideal for keeping in your tackle box for those Summer and Autumn rain showers. Jacket has a hood for extra protection. Material: 70% Polyester, 30% Polychloride. Gram weight: 70 g/m<sup>2</sup>

Code	Size	Content	Colour
8924 002	M	1 pcs	black
8924 003	L	1 pcs	black
8924 004	XL	1 pcs	black
8924 005	XXL	1 pcs	black
8924 006	XXXL	1 pcs	black

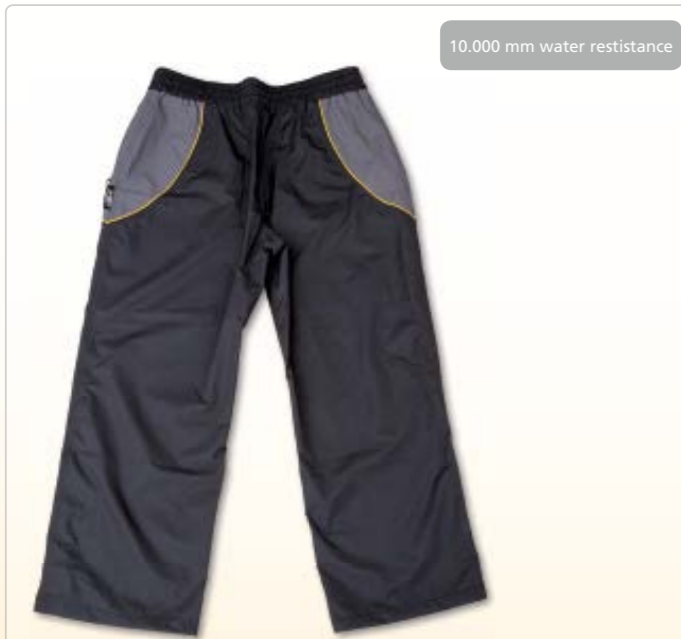

10.000 mm water resistance

### Xi-Dry WR 10 Overtrouser

Practical, waterproof overtrousers for the demanding coarse angler. The breathable material properties prevent sweating and subsequent cooling. Material: 100% Nylon, Polyurethane coated. Gram weight: 140 g/m<sup>2</sup>

Code	Size
8918 002	M
8918 003	L
8918 004	XL
8918 005	XXL
8918 006	XXXL



### Hoodie

Classic hooded sweatshirt in a design matching the Xi-Dry clothing range. Warm and comfortable during the changing of the seasons. Material: 80% Cotton, 20% Polyester. Gram weight: 340 g/m<sup>2</sup>

Code	Size
8909 002	M
8909 003	L
8909 004	XL
8909 005	XXL
8909 006	XXXL



### Overtrouser

These value-for-money trousers protect the angler's clothing from moisture and dirt, e.g. from groundbait. The trousers fold away to a very small size. Material: 100% Nylon. Gram weight: 70 g/m<sup>2</sup>

Code	Size	Content	Colour
8929 002	M	1 pcs	black
8929 003	L	1 pcs	black
8929 004	XL	1 pcs	black
8929 005	XXL	1 pcs	black
8929 006	XXXL	1 pcs	black



### Sweat shirt

Sleek, fashionable sweatshirt with high collar and first-class comfort for the wearer. 100% cotton. Material: 100% Cotton. Gram weight: 340 g/m<sup>2</sup>

Code	Size	Colour
8904 002	M	black
8904 003	L	black
8904 004	XL	black
8904 005	XXL	black
8904 006	XXXL	black





**Polo shirt**

Sleek, fashionable polo shirt with first-class comfort for the wearer. 100% cotton. Material: 100% Cotton. Gram weight: 220 g/m<sup>2</sup>

Code	Size	Colour
8905 002	M	black
8905 003	L	black
8905 004	XL	black
8905 005	XXL	black
8905 006	XXXL	black



**T-Shirt Exclusive**

Attractive T-Shirt with elaborate printing. Material: 100% Cotton. Gram weight: 220 g/m<sup>2</sup>

Code	Size	Colour
8906 002	M	black
8906 003	L	black
8906 004	XL	black
8906 005	XXL	black
8906 006	XXXL	black



**T-Shirt Classic**

White T-Shirt in proven Browning quality. The first choice in strong sunshine in particular. Material: 100% Cotton. Gram weight: 220 g/m<sup>2</sup>

Code	Size	Colour
8907 002	M	white
8907 003	L	white
8907 004	XL	white
8907 005	XXL	white
8907 006	XXXL	white



**Match Apron**

New design with separate leg sections that fix individually. Gives better freedom of movement for your legs! Material: 100% Polyester. Gram weight: 105 g/m<sup>2</sup>

Code
9789 005



**T-Shirt**

Eye-catching t-shirts in high-quality cotton. Material: 100% Cotton. Gram weight: 180 g/m<sup>2</sup>

Code	Size	Colour
8922 000	XS	black
8922 001	S	black
8922 002	M	black
8922 003	L	black
8922 004	XL	black
8922 005	XXL	black
8922 006	XXXL	black



**T-Shirt Classic**

Sand-coloured T-Shirt in proven Browning quality. Discreet and unobtrusive at the water's edge. Material: 100% Cotton. Gram weight: 220 g/m<sup>2</sup>

Code	Size	Colour
8908 002	M	sand
8908 003	L	sand
8908 004	XL	sand
8908 005	XXL	sand
8908 006	XXXL	sand



**Black Magic® waders**

Black Magic® neoprene waders with high-grip corrugated soles! Produced from 4.5 mm double-coated neoprene. The seams are bonded, with a hidden stitch line, and fused with a sealing strip on the inside. The boots are fully lined with neoprene. They are 100% watertight. The knees are reinforced. Material: Wader fabric: 90% neoprene, 10% nylon. Colour: black.. Gram weight: 22 g/m<sup>2</sup>

Code	Size	Colour
9318 040	40/41	black
9318 042	42/43	black
9318 044	44/45	black
9318 046	46/47	black



**Cap**

Material: 100% Cotton. Gram weight: 340 g/m<sup>2</sup>

Code	Model
9788 042	Tartan Cap

Trade Pack 5 Pieces



**Base Ball Cap**

Material: 100% Cotton. Gram weight: 340 g/m<sup>2</sup>

Code
9788 043

Trade Pack 5 Pieces





**Winter Warmer**

Cool winter hat for Browning fans that even keeps your ears warm in wind and cold weather. Material: 100% Nylon/100% Polyester. Gram weight: 340 g/m<sup>2</sup>

Code	Size
9788 056	L
9788 057	XL



**Browning CC Cap**

Material: 100% Cotton

Code
9788 061

Trade Pack 5 Pieces



**Hobo Cap**

Material: 100% Cotton

Code
9788 065

Trade Pack 5 Pieces



**Royal Cap**

Material: 100% Cotton

Code
9788 066

Trade Pack 5 Pieces



**Browning Visor**

Material: 100% Cotton

Code	Colour
9788 068	black H8505

Trade Pack 5 Pieces



**Browning Visor**

Material: 100% Cotton

Code	Colour
9788 069	white H9505

Trade Pack 5 Pieces



**Sunglasses Full Contact**

Fulfil two functions: firstly they protect the angler's eyes against harmful UV rays and secondly they improve visibility of a float or feeder tip etc. High quality with polarized lenses. Supplied with hard case and cleaning cloth.

grey	blue	red	dark grey
8910 001			8910 007
	8910 002	8910 003	

Trade Pack 3 Pieces



**Red Heat Sunglasses**

Stylish sunglasses with polarised effect. An absolute must for all anglers. The sunglasses not only protect the eyes against the sun's rays, they also allow anglers to spot fish in the water that they would otherwise miss thanks to their polarised effect.

Code
8910 012

Trade Pack 3 Pieces

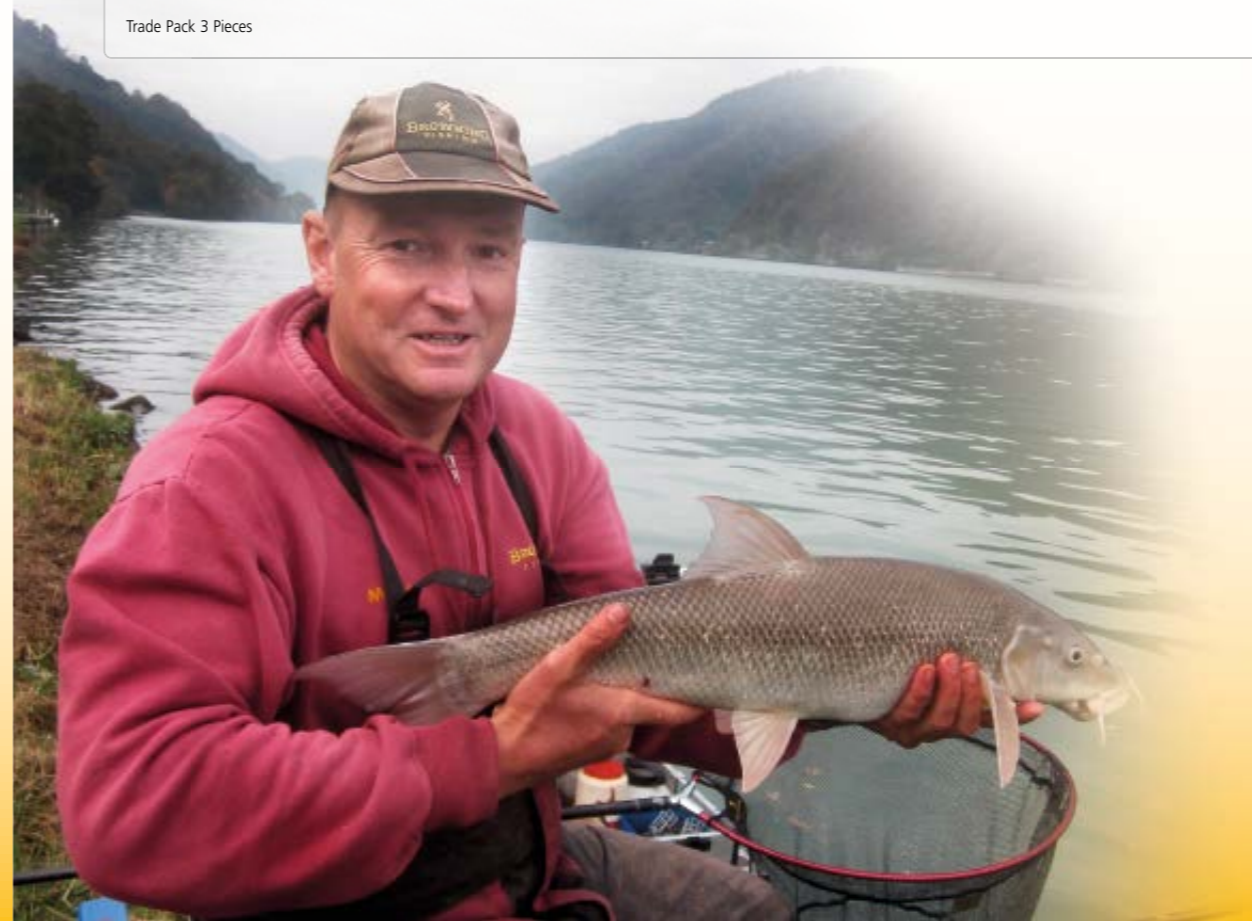





## Browning Banner

Material: 100% Nylon

Code	Width	Height
9963 503	200 cm	80 cm



## Browning Sticker

Code	Width	Height
9949 044	15 cm	7,5 cm
9949 043	24 cm	15 cm
9971 956	42 cm	10 cm



## Towel

Material: 100% Cotton

Code
9789 003

Trade Pack 6 Pieces



## Wipe It Towel

Convenient multi-purpose towel. Expands to 30 x 30 cm. Reusable.  
Material: 100% Cotton

Code	Width	Height	Content
9789 999	30 cm	30 cm	30 pcs

Trade Pack 30 Pieces



## Browning Rod Stand

Code	Width	Height	Depth
9963 501	60 cm	105 cm	43 cm



## Bowflag Browning

Includes flag, pole, base plate and bag.

Code	Width	Height
9966 052	60 cm	260 cm





**Quality carp tackle for monster specimens. High quality rods and reels, tried and tested accessories, irresistible baits – all combined with a cool image. Radical is the epitomy of modern carp sport par excellence.**







<b>REELS</b>	<b>RA 3</b>	<b>RODS</b>	<b>RA 6</b>	<b>ACCESSORIES</b>	<b>RA 10</b>	Holdall	RA 49
Ritual SLO	RA 3	Old School III Traditional	RA 6	Boilies & Additive	RA 10	Carryal, Bags & Bowls	RA 50
After Dark VM	RA 4	Old School III Hard River	RA 6	Displays, Tiger Nuts	RA 30	Tents	RA 54
Radical Carp Teaser BR	RA 5	Old School III Bateau Carpe	RA 6	Lines	RA 32	Tents & Truck	RA 56
Radical RCF	RA 5	After Dark	RA 8	Rigs	RA 34	Chairs, Bed Chairs, Carp Cradle	RA 58
		Warchild III	RA 8	Hooks & Accessories	RA 36	Unhooking Mat	RA 60
		Warchild Tele Carp III	RA 8	Leads & Tools	RA 40	Bait Bags & Clothing	RA 62
		Warchild 3G	RA 8	Accessories	RA 42	Caps & Sticker	RA 64
		Warchild Spod	RA 8	Bite Alarm	RA 45		
				Bank Sticks, Rod Pods	RA 47		



### RITUAL SLO

Large waters and monster fish require the ultimate fighting equipment. Now, carp anglers can present their bait where others cannot even begin to look. The Ritual SLO also impresses with its high-performance gears, making it your future partner for extreme requirements. Thanks to the slow spool stroke, line distribution is also of the highest standard, allowing the thinnest braids to be used and flow effortlessly from the spool.



Code	Model	m / mm	Gear Ratio	Retrieve	BB	Drag F.	Weight
0354 070	1070	330 / 0,40	4,9:1	102 cm	10	10,0 kg / 22 lbs	715 g
0354 080	1080	420 / 0,40	4,9:1	105 cm	10	10,0 kg / 22 lbs	745 g

#### STANDARD TECHNICAL EQUIPMENT:

- Large-surface multi-disc front drag system
- CNC stainless steel handle
- Anti-twist line roller
- Powerful gears
- Aluminium Long Stroke™ spool
- Aluminium spare spool
- Wormshaft oscillation system

Spare Spool	Model	m / mm	Material
0987 110	Sp.Spool Ritual SLO 1070	330 / 0,40	Alu
0987 111	Sp.Spool Ritual SLO 1080	420 / 0,40	Alu

kompletný cenník na [www.SPORTS.sk](http://www.SPORTS.sk), výhradný distribútor pre SR: SPORTS s.r.o.





### AFTER DARK VM

Top big pit reels for the ambitious carp angler. The After Dark VM 570 impressively lives up to this description. The model boasts a high degree of functionality. Besides the optimised long-cast spool, the reel impresses with its high-performance wormshaft gears and ergonomic handle knob. A first-class, smooth-running front drag is obviously essential.

#### STANDARD TECHNICAL EQUIPMENT:

- CarbonGraphite rotor
- Graphite body
- Finely adjustable large-surface front drag
- CNC stainless steel handle
- Anti-twist line roller
- Robust worm shaft power gears
- Aluminium Long Stroke™ spool
- Wormshaft oscillation system
- Continuous anti-reverse



Code	Model	m / mm	Gear Ratio	Retrieve	BB	Drag F.	Weight	Spare Spool	Model	m / mm
0355 070	570	400 / 0,40	4,6:1	94 cm	5	10 kg / 22 lbs	638 g	0987 112	Sp.Spool After Dark VM 570	400 / 0,40

### RADICAL CARP TEASER BR

This run control reel has been designed for die-hard angling. We have deliberately dispensed with all of the frills. Whether on the big French reservoirs or the wild rivers of Eastern Europe, this reel impresses with its extreme and unprecedented robustness. The reel has enormous drag strength that will reliably stop even large specimens in their tracks. The drag kicks in reliably and cleanly. A masterpiece among carp reels!

#### STANDARD TECHNICAL EQUIPMENT:

- Housing produced in aluminium to be completely distortion-free
- Oversized multi-stack drag system
- Finely adjustable run control system
- Non-twist line roller
- Thick bail arm for optimal balance
- Gears made from a super-hard stainless steel alloy
- Continuous anti-reverse



Code	Model	m / mm	Gear Ratio	Retrieve	BB	Drag F.	Weight	Spare Spool	Model	Material
0281 060	660	220 / 0,40	4.9:1	86 cm	6	10,9 kg / 24 lbs	672 g	0987 289	Sp.Spool Radical Carp T. BR660	Alu
0281 080	680	270 / 0,45	4.9:1	102 cm	6	17,2 kg / 38 lbs	773 g	0987 290	Sp.Spool Radical Carp T. BR680	Alu



### RADICAL RCF

Ultra modern and innovative run control reel range for carp and predator sport fishing, which is available in 5 sizes. Whether for moderate coarse fishing or extreme adventure you will be convinced that you have the right model to suit your requirements. The two largest versions have been fitted with worm shaft transmissions to handle the additional load. Many carp will suffer defeat at the hands of the powerful transmission and refined drag of this reel range.

#### STANDARD TECHNICAL EQUIPMENT:

- Balanced rotor, producing silky smooth action
- Finely adjustable large-surface front drag
- Finely adjustable run control system
- Ergonomically designed handle knob for optimal power transfer
- Robust power gears
- Deep aluminium spool
- Plastic spare spool
- Continuous anti-reverse



Code	Model	m / mm	Gear Ratio	Retrieve	BB	Drag F.	Spare Spool	Weight	Spare Spool	Model	m / mm	Material
0253 040	640	260 / 0,30	4.9:1	78 cm	6	5,4 kg / 12 lbs	0987 168	465 g	0987 168	deep		Alu
0253 050	650	220 / 0,35	4.9:1	82 cm	6	5,4 kg / 12 lbs	0987 170	467 g	0987 170	deep		Alu
0253 060	660	400 / 0,40	4.9:1	106 cm	6	8,2 kg / 18 lbs	0987 172 / 0987 173	550 g	0987 172	deep		Alu
0253 070	670	480 / 0,40	4.7:1	115 cm	6	12,2 kg / 27 lbs	0987 174 / 0987 175	797 g	0987 173	shallow	340 / 0,30	Alu
									0987 174	deep		Alu
									0987 175	shallow	450 / 0,30	Alu





Code	Model	Length	Sections	C.W.	Tr.-Length	Weight
1891 360	Old School III Traditional	3,60 m / 12'	2	1,75 lbs	1,88 m	267 g
1891 361	Old School III Traditional	3,60 m / 12'	2	2,25 lbs	1,88 m	296 g
1891 362	Old School III Traditional	3,60 m / 12'	2	2,75 lbs	1,88 m	338 g
1891 363	Old School III Traditional	3,60 m / 12'	2	3 lbs	1,88 m	362 g

**OLD SCHOOL III TRADITIONAL**  
 Top-class fully parabolic rods with incredible power reserves. Finished with elegant cork handle, ALPS rings and FUJI reel holder. The woven-mesh blank was tested by our team angler Robin Illner on waters throughout Europe. The verdict: indestructible!



Code	Model	Length	Sections	C.W.	Tr.-Length	Weight
1893 361	Old School III Hard River	3,60 m / 12'	2	3,5 lbs	1,88 m	392 g
1893 390	Old School III Hard River	3,90 m / 13'	2	3,5 lbs	2,03 m	443 g

**OLD SCHOOL III HARD RIVER**  
 Hard, harder, Hard River! That is the motto of the dynamic and extremely powerful river rod for taming violent river carp. Robin Illner has tailored the rod to the requirements of river fishing. The result is a parabolic yet highly powerful woven-mesh blank that can withstand the harshest conditions. The rod provides security and fighting pleasure on even the largest rivers in Europe. Additional equipment includes ALPS rings and an FUJI reel holder.



Code	Model	Length	Sections	C.W.	Tr.-Length	Weight
1894 300	Old School III Bateau Carpe	3,00 m / 10'	2	3,5 lbs	1,55 m	293 g
1894 301	Old School III Bateau Carpe	3,00 m / 10'	2	4,5 lbs	1,56 m	329 g

**OLD SCHOOL III BATEAU CARPE**  
 Carp angling from a boat is highly popular at the moment. However, long rods have no place on boats. Short rods offer the ability to tame fish from the boat while making handling far easier. Rigs can also be dropped into wood-filled swims or weed with precision. The elegant rod with cork handle, ALPS rings and FUJI reel holder has been equipped with a powerful 3.5-lb woven-mesh blank.



kompletný cenník na [www.SPORTS.sk](http://www.SPORTS.sk), výhradný distribútor pre SR: SPORTS s.r.o.





Code	Model	Length	Sections	C.W.	Tr.-Length	Weight
16001 300	After Dark	3,00 m / 10'	2	3,50 lbs	1,72 m	315 g
16001 360	After Dark	3,60 m / 12'	2	2,75 lbs	1,87 m	345 g
16001 361	After Dark	3,60 m / 12'	2	3,00 lbs	1,87 m	355 g
16001 390	After Dark	3,90 m / 13'	2	3,50 lbs	2,02 m	465 g

**AFTER DARK**  
 The new ultra-cool carp rod for fanatics for whom no session is too hard-core. With its fantastic casting action and huge range, the model also boasts sufficient backbone to break the resistance of specimen-size carp.



Code	Model	Length	Sections	C.W.	Tr.-Length	Weight
16015 360	Warchild III	3,60 m	2	2,75 lbs	1,84 m	340 g
16015 361	Warchild III	3,60 m	2	3,00 lbs	1,84 m	430 g
16015 362	Warchild III	3,60 m	3	3,00 lbs	1,26 m	435 g

**WARCHILD III**  
 An incredibly slim carp rod for the price segment. The pleasant semi-parabolic action is as well balanced for casting as it is during a fight. Limitless power without compromising on sensitivity. Classic, two-piece design.



Code	Model	Length	Sections	C.W.	Tr.-Length	Weight
16012 360	Warchild Tele Carp III	3,60 m	6	2,75 lbs	1,23 m	285 g
16012 390	Warchild Tele Carp III	3,90 m	7	3,00 lbs	1,41 m	380 g

**WARCHILD TELE CARP III**  
 Carp angling is becoming ever more global. A few years ago, many carp anglers were content to explore their own country and their closest neighbouring country. Now, tours extend to Morocco, Africa and even Australia. With this in mind, our team has developed an outstanding range of telescopic rods. The action of these telescopic rods is so impressive, it is barely distinguishable from that of traditional rods. The Warchild has enough in its armoury to overcome any opponent!



Code	Model	Length	Sections	Tr.-Length	Testcurve	Weight
16004 300	Warchild 3G	3,00 m / 10'	2	1,54 m	3,00 lbs	336 g

**WARCHILD 3G**  
 A fantastic, slender carp rod with a pleasant, semi-parabolic action. As well balanced for casting as it is during a fight. Limitless power without compromising on sensitivity. Classic, two-piece design in the increasingly popular length of 3 m (10 feet). Ideal for fighting from the boat.



Code	Model	Length	Sections	Tr.-Length	Testcurve	Weight
16005 393	Warchild Spod	3,90 m / 13'	2	2,01 m	5,00 lbs	417 g

**WARCHILD SPOD**  
 The Radical Warchild Spod Rod is tough and rigid on the take. The spod rod punches out even heavy bait rock-ets and spombs to your swim, proving its backbone. An outstanding alternative to boats and bait boats.



kompletný cenník na [www.SPORTS.sk](http://www.SPORTS.sk), výhradný distribútor pre SR: SPORTS s.r.o.





Resealable bags! **NEW**

### HIGHWAY TO SMELL BOILIE

Our test anglers' expectations of this boilie were more than demanding and set us a genuine challenge: as many insects as possible in different variations, enriched with blood meal, egg albumen and natural flours. This is intended to produce as coarse a structure as possible, which does not necessarily make matters easier. The result is in front of you: a dream carp bait without rival on the European market! Suitable for any time of year, fast-acting and hence completely suited to short sessions. The result of perfect collaboration between developers and test anglers will also make you a successful carp angler!

Code	Ø	Contents
3666 001	16 mm	1 kg
3666 002	20 mm	1 kg
3666 003	24 mm	0,8 kg

Supplied as: 6 bags of each type in package.  
Trade Pack 6 Pieces



Resealable bags! **NEW**

### HIGHWAY TO SMELL BOILIE

Our test anglers' expectations of this boilie were more than demanding and set us a genuine challenge: as many insects as possible in different variations, enriched with blood meal, egg albumen and natural flours. This is intended to produce as coarse a structure as possible, which does not necessarily make matters easier. The result is in front of you: a dream carp bait without rival on the European market! Suitable for any time of year, fast-acting and hence completely suited to short sessions. The result of perfect collaboration between developers and test anglers will also make you a successful carp angler!

Code	Ø	Contents
3666 001	16 mm	1 kg
3666 002	20 mm	1 kg
3666 003	24 mm	0,8 kg

Supplied as: 6 bags of each type in package.  
Trade Pack 6 Pieces



**NEW**

### METHOD MARBLES

Small 9mm versions of our renowned Radical-Boilies open up the range to other coarse anglers. Outstanding for barbel and tench, for example, as well as method feeder fishing.

Code	Model	Ø	Contents	Action
3962 110	Highway to Smell	9 mm	75 g	sinking

Trade Pack 6 Pieces



**NEW**

### METHOD DUMBLE

Small 8x10 mm Dumble versions of our renowned Radical-Boilies open up the range to other coarse anglers. Outstanding for barbel and tench, for example, as well as method feeder fishing.

Code	Model	Ø	Contents	Action
3962 610	Highway to Smell	8 mm / 10 mm	75 g	sinking

Trade Pack 6 Pieces



**NEW**

### HIGHWAY TO SMELL DIP

The unmistakable aroma combined with the solubility of the alcohol make this dip truly special. The dip works quickly, attracting fish into the swim in no time at all. Our tip: Treat a large amount of boilies with Highway to Smell Dip before first feeding in the target area. This will bring fish into the swim in no time.

Code	Contents
3666 004	150 ml

Trade Pack 6 Pieces



including flavour capsule **NEW**

### HIGHWAY TO SMELL POP UP'S

Firm pop-up boilies that retain their buoyancy for a long period. Perfect for use with Highway to Smell Boilies. Each tub comes with two different diameters ensuring you can always make the right choice of pop-up for the conditions. Flavour capsule included to boost the pop ups.

Code	Ø	Contents
3666 007	16 mm / 20 mm	75 g

Trade Pack 6 Pieces

### HIGHWAY TO SMELL PILLOW

Our test anglers' expectations of this boilie were more than demanding and set us a genuine challenge: as many insects as possible in different variations, enriched with blood meal, egg albumen and natural flours. This is intended to produce as coarse a structure as possible, which does not necessarily make matters easier. The result is in front of you: a dream carp bait without rival on the European market! Suitable for any time of year, fast-acting and hence completely suited to short sessions. The result of perfect collaboration between developers and test anglers will also make you a successful carp angler!

Code	Size	Contents
3666 008	20 x 20 mm	1 kg

Supplied as: 6 bags of each type in package.  
Trade Pack 6 Pieces



**NEW**

### MARBLE SPRAY

This spray impregnates baits and particles with the precise flavours of our Radical-Boilies. This increases their attractiveness tremendously.

Code	Model	Contents
3949 032	Highway to Smell	100 ml

Trade Pack 6 Pieces



including flavour capsule **NEW**

### HIGHWAY TO SMELL NEON POP UPS

When you want to light up your pop-ups, fluorescent colours are ideal. Now there is a Neon Pop-Up boilie to match the Highway to Smell. Colour: red.

Code	Ø	Contents
3666 005	16 mm / 20 mm	75 g

Trade Pack 6 Pieces



**NEW**

### HIGHWAY TO SMELL NEON POWDER

Ultra-clever option for giving boilies a 'second skin' for additional attraction. Simply roll the wet boilie in the powder – and you're ready! The gel-like shell entices fish with its striking colour and intensive aroma

Code	Contents
3666 006	50 g

Trade Pack 6 Pieces



**NEW**

### STICKER

Code	Model	Width	Height
9949 073	Highway to Smell	14,5 cm	9,5 cm

Trade Pack 10 Pieces







Resealable bags!

NEW

**RASTAFARI BOILIE**

Who has not heard of our yellow Scopex Boilies with their unmistakable butter aroma with a hint of vanilla? To optimise their attraction, our boilie is based upon a balanced mix of natural flours combined with a blend of crushed and whole hemp, produced with real butyric acid. We have given priority to ensuring that the boilie releases its aroma and various ingredients within the shortest possible time and attracts carp quickly to your swim. The catches achieved during various tests were outstanding!

Code	Ø	Contents
3979 001	16 mm	1 kg
3979 002	20 mm	1 kg
3979 003	24 mm	0,8 kg

Supplied as: 6 bags of each type in package.  
Trade Pack 6 Pieces



Resealable bags!

NEW



NEW

**METHOD MARBLES**

Small 9mm versions of our renowned Radical-Boilies open up the range to other coarse anglers. Outstanding for barbel and tench, for example, as well as method feeder fishing.

Code	Model	Ø	Contents	Action
3962 111	Rastafari	9 mm	75 g	sinking

Trade Pack 6 Pieces



NEW

**METHOD DUMBLE**

Small 8x10 mm Dumble versions of our renowned Radical-Boilies open up the range to other coarse anglers. Outstanding for barbel and tench, for example, as well as method feeder fishing.

Code	Model	Ø	Contents	Action
3962 611	Rastafari	8 mm / 10 mm	75 g	sinking

Trade Pack 6 Pieces



NEW

**RASTAFARI DIP**

The unmistakable aroma combined with the solubility of the alcohol make this dip truly special. The dip works quickly, attracting fish into the swim in no time at all. Our tip: Treat a large amount of boilies with Rastafari Dip before first feeding in the target area. This will bring fish into the swim in no time.

Code	Contents
3979 004	150 ml

Trade Pack 6 Pieces



including flavour capsule

NEW

**RASTAFARI POP UPS**

Firm pop-up boilies that retain their buoyancy for a long period. Perfect for use with Rastafari Boilies. Each tub comes with two different diameters ensuring you can always make the right choice of pop-up for the conditions. Flavour capsule included to boost the pop ups.

Code	Ø	Contents
3979 007	16 mm / 20 mm	75 g

Trade Pack 6 Pieces



including flavour capsule

NEW

**RASTAFARI NEON POP UPS**

When you want to light up your pop-ups, fluorescent colours are ideal. Now there is a Neon Pop-Up boilie to match the Rastafari. Colour: green

Code	Ø	Contents
3979 005	16 mm / 20 mm	75 g

Trade Pack 6 Pieces



NEW

**RASTAFARI NEON POWDER**

Ultra-clever option for giving boilies a 'second skin' for additional attraction. Simply roll the wet boilie in the powder – and you're ready! The gel-like shell entices fish with its striking colour and intensive aroma

Code	Contents
3979 006	50 g

Trade Pack 6 Pieces



NEW

**STICKER**

Code	Model	Width	Height
9949 074	Rastafari	14,5 cm	9,5 cm

Trade Pack 10 Pieces



NEW

**MARBLE SPRAY**

This spray impregnates baits and particles with the precise flavours of our Radical-Boilies. This increases their attractiveness tremendously.

Code	Model	Contents
3949 033	Rastafari	100 ml

Trade Pack 6 Pieces



kompletný cenník na [www.SPORTS.sk](http://www.SPORTS.sk), výhradný distribútor pre SR: SPORTS s.r.o.





Resealable bags!

**PUNKY MONKEY BOILIE**

This unique symphony of wild strawberries and tropical bananas with a dash of coconut not only drives apes wild! From the early days of specimen carp angling, you could enjoy some magical moments with strawberry boilies. Today, using the latest knowledge from the fields of biology and feed law, we have designed a two-layer boilie that re-connects to these early successes. With an inner core of banana and coconut and an outer coating of strawberry, this boilie will bring the most cautious fish to your hook even under the most challenging conditions.

Code	Ø	Contents
3963 001	16 mm	1 kg
3963 002	20 mm	1 kg
3963 003	24 mm	0,8 kg

Supplied as: 6 bags of each type in package.  
Trade Pack 6 Pieces



Resealable bags!



**METHOD MARBLES**

Small 9mm versions of our renowned Radical-Boilies open up the range to other coarse anglers. Outstanding for barbel and tench, for example, as well as method feeder fishing.

Code	Model	Ø	Contents	Action
3962 109	Punky Monkey	9 mm	75 g	sinking

Trade Pack 6 Pieces



**METHOD DUMBLE**

Small 8x10 mm Dumble versions of our renowned Radical-Boilies open up the range to other coarse anglers. Outstanding for barbel and tench, for example, as well as method feeder fishing.

Code	Model	Ø	Contents	Action
3962 609	Punky Monkey	8 mm / 10 mm	75 g	sinking

Trade Pack 6 Pieces



**PUNKY MONKEY DIP**

The unmistakable aroma combined with the solubility of the alcohol make this dip truly special. The dip works quickly, attracting fish into the swim in no time at all. Our tip: Treat a large amount of boilies with tiger nuts Dip before first feeding in the target area. This will bring fish into the swim in no time.

Code	Contents
3963 004	150 ml

Trade Pack 6 Pieces



including flavour capsule

**PUNKY MONKEY POP UP'S**

Firm pop-up boilie with long-lasting buoyancy, perfectly suited to the Punky Monkey Boilie. Each tube comes with two different diameters ensuring you can always make the right choice of pop-up for the conditions. Flavour capsule included to boost the pop ups.

Code	Ø	Contents
3963 007	16 mm / 20 mm	75 g

Trade Pack 6 Pieces



including flavour capsule

**PUNKY MONKEY NEON POP UP'S**

When you want to light up your pop-ups, fluorescent colours are ideal. Now there is a Neon Pop-Up boilie to match the Punky Monkey. Colour: Neon red

Code	Ø	Contents
3963 005	16 mm / 20 mm	75 g

Trade Pack 6 Pieces



**PUNKY MONKEY NEON POWDER**

Ultra-clever option for giving boilies a 'second skin' for additional attraction. Simply roll the wet boilie in the powder – and you're ready! The gel-like shell entices fish with its striking colour and intensive aroma

Code	Contents
3963 006	50 g

Trade Pack 6 Pieces

**PUNKY MONKEY PILLOW**

This unique symphony of wild strawberries and tropical bananas with a dash of coconut not only drives apes wild! From the early days of specimen carp angling, you could enjoy some magical moments with strawberry boilies. Today, using the latest knowledge from the fields of biology and feed law, we have designed a two-layer boilie that re-connects to these early successes. With an inner core of banana and coconut and an outer coating of strawberry, this boilie will bring the most cautious fish to your hook even under the most challenging conditions.

Code	Size	Contents
3963 008	20 x 20 mm	1 kg

Supplied as: 6 bags of each type in package.  
Trade Pack 6 Pieces

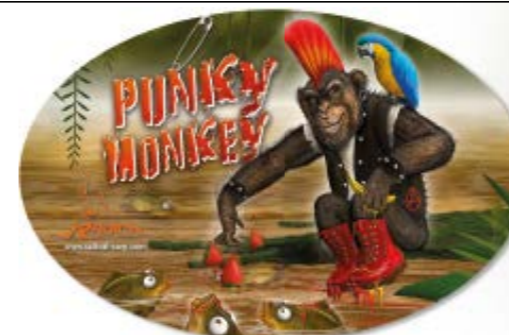

**STICKER**

Code	Model	Width	Height
9949 071	Punky Monkey	14,5 cm	9,5 cm

Trade Pack 10 Pieces



**MARBLE SPRAY**

This spray impregnates baits and particles with the precise flavours of our Radical-Boilies. This increases their attractiveness tremendously.

Code	Model	Contents
3949 031	Punky Monkey	100 ml

Trade Pack 6 Pieces





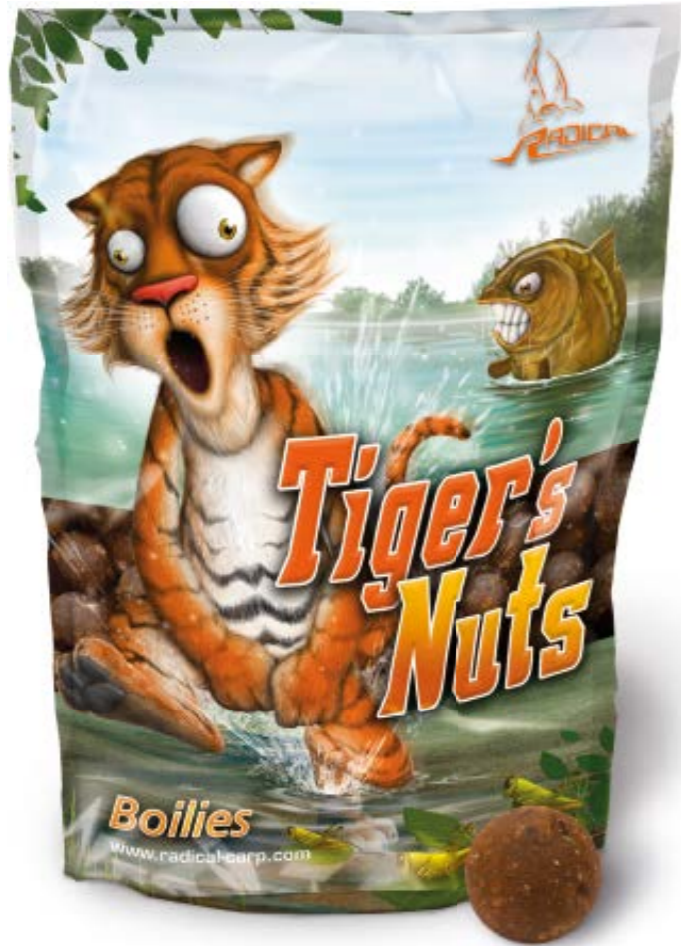

Resealable bags!

**TIGER'S NUTS BOILIE**

The magical effect of tiger nuts on carp is well known all over Europe. The Radical Team has developed a new Top Boilie, the ingredients feature a high proportion of ground tiger nuts as well as large chunks of black tiger nuts. In order to maintain a high protein content and nutritional value, we have added dried whole grasshoppers, soy meal and egg albumin. The boilie releases its aroma quickly under water, but stays on the hook firmly during long sessions. Hold on to your nuts!

Code	Ø	Contents
3938 001	16 mm	1 kg
3938 002	20 mm	1 kg
3938 003	24 mm	0,8 kg

Supplied as: 6 bags of each type in package.  
Trade Pack 6 Pieces

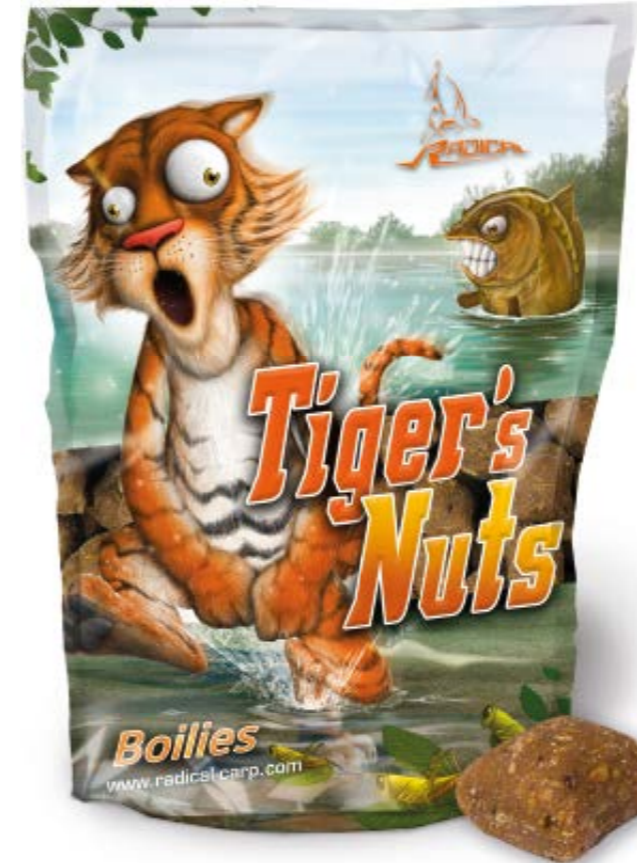

Resealable bags!



**METHOD MARBLES**

Small 9mm versions of our renowned Radical-Boilies open up the range to other coarse anglers. Outstanding for barbel and tench, for example, as well as method feeder fishing.

Code	Model	Ø	Contents	Action
3962 108	Tiger's Nuts	9 mm	75 g	sinking

Trade Pack 6 Pieces



**METHOD DUMBLE**

Small 8x10 mm Dumble versions of our renowned Radical-Boilies open up the range to other coarse anglers. Outstanding for barbel and tench, for example, as well as method feeder fishing.

Code	Model	Ø	Contents	Action
3962 608	Tiger's Nuts	8 mm / 10 mm	75 g	sinking

Trade Pack 6 Pieces



**TIGER'S NUTS DIP**

The unmistakable aroma combined with the solubility of the alcohol make this dip truly special. The dip works quickly, attracting fish into the swim in no time at all. Our tip: Treat a large amount of boilies with tiger nuts Dip before first feeding in the target area. This will bring fish into the swim in no time.

Code	Contents
3938 004	150 ml

Trade Pack 6 Pieces



including flavour capsule

**TIGER'S NUTS POP UP'S**

Firm pop-up boilie with long-lasting buoyancy, perfectly suited to the Tiger's Nuts Boilie. Each tube comes with two different diameters ensuring you can always make the right choice of pop-up for the conditions. Flavour capsule included to boost the pop ups.

Code	Ø	Contents
3938 007	16 mm / 20 mm	75 g

Trade Pack 6 Pieces



including flavour capsule

**TIGER'S NUTS NEON POP UP'S**

When you want to light up your pop-ups, fluorescent colours are ideal. Now there is a Neon Pop-Up boilie to match the Tiger's Nuts. Colour: Neon purple

Code	Ø	Contents
3938 005	16 mm / 20 mm	75 g

Trade Pack 6 Pieces



**TIGER'S NUTS NEON POWDER**

Ultra-clever option for giving boilies a 'second skin' for additional attraction. Simply roll the wet boilie in the powder – and you're ready! The gel-like shell entices fish with its striking colour and intensive aroma

Code	Contents
3938 006	50 g

Trade Pack 6 Pieces

**TIGER'S NUTS PILLOW**

The magical effect of tiger nuts on carp is well known all over Europe. The Radical Team has developed a new Top Boilie, the ingredients feature a high proportion of ground tiger nuts as well as large chunks of black tiger nuts. In order to maintain a high protein content and nutritional value, we have added dried whole grasshoppers, soy meal and egg albumin. The boilie releases its aroma quickly under water, but stays on the hook firmly during long sessions. Hold on to your nuts!

Code	Size	Contents
3938 008	20 x 20 mm	1 kg

Supplied as: 6 bags of each type in package.  
Trade Pack 6 Pieces

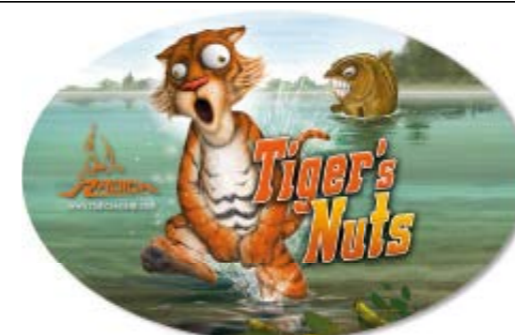

**STICKER**

Code	Model	Width	Height
9949 024	Tiger's Nuts	14,5 cm	9,5 cm

Trade Pack 10 Pieces



**MARBLE SPRAY**

This spray impregnates baits and particles with the precise flavours of our Radical-Boilies. This increases their attractiveness tremendously.

Code	Model	Contents
3949 030	Tiger's Nuts	100 ml

Trade Pack 6 Pieces







Resealable bags!

**CRAZY CLINIC BOILIE**

Crazy Clinic - A crazy boilie with an exciting combination of different aromas. And it's made up of two layers. The inside is a softish, red mix with a fruity taste and mini-pellets, and on the outside is an irresistible, fragrant combination of ingredients. The white colour is unmissable for the carp!

Code	Ø	Contents
3960 002	20 mm	1 kg
3960 003	24 mm	0,8 kg

Supplied as: 6 bags of each type in package.  
Trade Pack 6 Pieces



Resealable bags!



**METHOD MARBLES**

Small 9mm versions of our renowned Radical-Boilies open up the range to other coarse anglers. Outstanding for barbel and tench, for example, as well as method feeder fishing.

Code	Model	Ø	Contents	Action
3962 101	Crazy Clinic	9 mm	75 g	sinking

Trade Pack 6 Pieces



**METHOD DUMBLE**

Small 8x10 mm Dumble versions of our renowned Radical-Boilies open up the range to other coarse anglers. Outstanding for barbel and tench, for example, as well as method feeder fishing.

Code	Model	Ø	Contents	Action
3962 601	Crazy Clinic	8 mm / 10 mm	75 g	sinking

Trade Pack 6 Pieces



**CRAZY CLINIC DIP**

The unmistakable aroma combined with the solubility of the alcohol make this dip truly special. The dip works quickly, attracting fish into the swim in no time at all. Our tip: Treat a large amount of boilies with Crazy Clinic Dip before first feeding in the target area. This will bring fish into the swim in no time.

Code	Contents
3949 006	150 ml

Trade Pack 6 Pieces



including flavour capsule

**CRAZY CLINIC POP UP'S**

Firm pop-up boilies that retain their buoyancy for a long period. Perfect for use with Crazy Clinic Boilies. Each tub comes with two different diameters ensuring you can always make the right choice of pop-up for the conditions. Flavour capsule included to boost the pop ups.

Code	Ø	Contents
3949 004	16 mm / 20 mm	75 g

Trade Pack 6 Pieces



including flavour capsule

**CRAZY CLINIC NEON POP UP'S**

When you want to light up your pop-ups, fluorescent colours are ideal. Now there is a Neon Pop-Up boilie to match the Crazy Clinic. Colour: White.

Code	Ø	Contents
3949 005	16 mm / 20 mm	75 g

Trade Pack 6 Pieces



**CRAZY CLINIC NEON POWDER**

Ultra-clever option for giving boilies a 'second skin' for additional attraction. Simply roll the wet boilie in the powder – and you're ready! The gel-like shell entices fish with its striking colour and intensive aroma

Code	Contents
3949 021	50 g

Trade Pack 6 Pieces

**CRAZY CLINIC PILLOW**

Crazy Clinic - A crazy boilie with an exciting combination of different aromas. And it's made up of two layers. The inside is a softish, red mix with a fruity taste and mini-pellets, and on the outside is an irresistible, fragrant combination of ingredients. The white colour is unmissable for the carp!

Code	Size	Contents
3960 008	20 x 20 mm	1 kg

Supplied as: 6 bags of each type in package.  
Trade Pack 6 Pieces



**MARBLE SPRAY**

This spray impregnates baits and particles with the precise flavours of our Radical-Boilies. This increases their attractiveness tremendously.

Code	Model	Contents
3949 023	Crazy Clinic	100 ml

Trade Pack 6 Pieces



**STICKER**

Code	Model	Width	Height
9949 020	Crazy Clinic	14,5 cm	9,5 cm

Trade Pack 10 Pieces





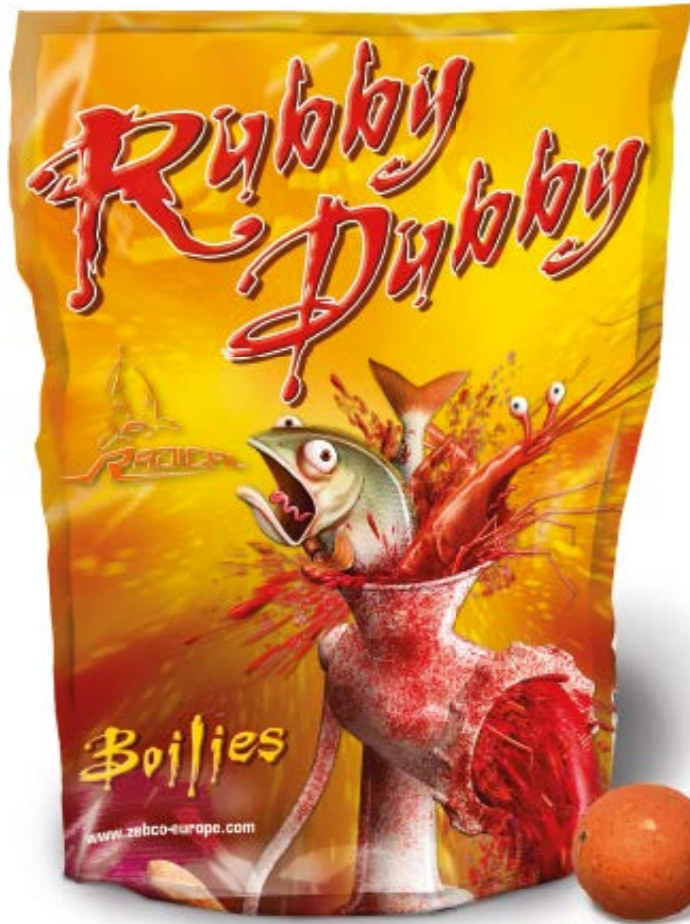

Resealable bags!

**RUBBY DUBBY BOILIE**

Fishy, natural and coarse – everything a carp could wish for! A bait for the future because naturalness counts and at Radical we only use natural ingredients. The success of our baits proves us right:

- Real fish- and shrimp chunks for the „crack and crunch“ effect
- Real fish oils for aroma and flavour instead of artificial fish flavourings
- Bait activates and immediately sets to work in the water since it contains no preservatives
- Top quality flours trigger a feeding frenzy in carp and ensure the bait is digested quickly

Code	Ø	Contents
3954 009	16 mm	1 kg
3955 009	20 mm	1 kg
3956 009	24 mm	1 kg

Supplied as: 6 bags of each type in package.  
Trade Pack 6 Pieces



Resealable bags!

**RUBBY DUBBY PILLOW**

Fishy, natural and coarse – everything a carp could wish for! A bait for the future because naturalness counts and at Radical we only use natural ingredients. The success of our baits proves us right:

- Real fish- and shrimp chunks for the „crack and crunch“ effect
- Real fish oils for aroma and flavour instead of artificial fish flavourings
- Bait activates and immediately sets to work in the water since it contains no preservatives
- Top quality flours trigger a feeding frenzy in carp and ensure the bait is digested quickly

Code	Size	Contents
3955 011	20 x 20 mm	1 kg

Supplied as: 6 bags of each type in package.  
Trade Pack 6 Pieces



**METHOD MARBLES**

Small 9mm versions of our renowned Radical-Boilies open up the range to other coarse anglers. Outstanding for barbel and tench, for example, as well as method feeder fishing.

Code	Model	Ø	Contents	Action
3962 103	Rubby Dubby	9 mm	75 g	sinking

Trade Pack 6 Pieces



**METHOD DUMBLE**

Small 8x10 mm Dumble versions of our renowned Radical-Boilies open up the range to other coarse anglers. Outstanding for barbel and tench, for example, as well as method feeder fishing.

Code	Model	Ø	Contents	Action
3962 603	Rubby Dubby	8 mm / 10 mm	75 g	sinking

Trade Pack 6 Pieces



**RUBBY DUBBY DIP**

Natural ingredients were given top priority with the Rubby Dubby Dip. These ingredients guarantee rapid solubility at all temperatures and strong attraction even when the fish are far away. "Fishy" ingredients make our Rubby Dubby Boilie a bait for all seasons and the bait's attraction is multiplied by using the dip.

Code	Contents
3950 009	150 ml

Trade Pack 6 Pieces



including flavour capsule

**RUBBY DUBBY POP UP'S**

Firm Pop-Ups, suitable for use with the Radical Rubby Dubby Range, which float for a particularly long time. Each tube comes with two different diameters ensuring you can always make the right choice of pop-up for the conditions. Flavour capsule included to boost the pop ups.

Code	Ø	Contents
3943 009	16 mm / 20 mm	75 g

Trade Pack 6 Pieces



including flavour capsule

**RUBBY DUBBY NEON POP UP'S**

When you want to light up your pop-ups, fluorescent colours are ideal. Now there is a Neon Pop-Up boilie to match the Rubby Dubby. Colour: fluorescent orange

Code	Ø	Contents
3943 054	16 mm / 20 mm	75 g

Trade Pack 6 Pieces



**RUBBY DUBBY NEON POWDER**

Ultra-clever option for giving boilies a „second skin“ for additional attraction. Simply roll the wet boilie in the powder – and you're ready! The gel-like shell entices fish with its striking colour and intensive aroma

Code	Weight
3949 016	50 g

Trade Pack 6 Pieces



**STICKER**

Code	Model	Width	Height
9949 015	Rubby Dubby	14,5 cm	9,5 cm

Trade Pack 10 Pieces



**MARBLE SPRAY**

This spray impregnates baits and particles with the precise flavours of our Radical-Boilies. This increases their attractiveness tremendously.



Code	Model	Contents
3949 025	Rubby Dubby	100 ml

Trade Pack 6 Pieces





Resealable bags!

**YELLOW ZOMBIE BOILIE**

The fruitiest temptation since boilies began! A bait for the future because naturalness counts, and at Radical we only use natural ingredients. The success of our baits proves us right:

- Real fruit for the "crack and crunch" effect
- Sweet fruit nectar instead of artificial sweeteners
- Bait activates and immediately sets to work in the water since it contains no artificial preservatives
- Top quality flours trigger feeding in carp and ensure the bait is digested quickly

Code	Ø	Contents
3954 010	16 mm	1 kg
3955 010	20 mm	1 kg
3956 010	24 mm	1 kg

Supplied as: 6 bags of each type in package.  
Trade Pack 6 Pieces



Resealable bags!

**YELLOW ZOMBIE PILLOW**

The fruitiest temptation since boilies began! A bait for the future because naturalness counts, and at Radical we only use natural ingredients. The success of our baits proves us right:

- Real fruit for the "crack and crunch" effect
- Sweet fruit nectar instead of artificial sweeteners
- Bait activates and immediately sets to work in the water since it contains no artificial preservatives
- Top quality flours trigger feeding in carp and ensure the bait is digested quickly

Code	Size	Contents
3955 012	20 x 20 mm	1 kg

Supplied as: 6 bags of each type in package.  
Trade Pack 6 Pieces



**METHOD MARBLES**

Small 9mm versions of our renowned Radical-Boilies open up the range to other coarse anglers. Outstanding for barbel and tench, for example, as well as method feeder fishing.

Code	Model	Ø	Contents	Action
3962 104	Yellow Zombie	9 mm	75 g	sinking

Trade Pack 6 Pieces



**METHOD DUMBLE**

Small 8x10 mm Dumble versions of our renowned Radical-Boilies open up the range to other coarse anglers. Outstanding for barbel and tench, for example, as well as method feeder fishing.

Code	Model	Ø	Contents	Action
3962 604	Yellow Zombie	8 mm / 10 mm	75 g	sinking

Trade Pack 6 Pieces



**YELLOW ZOMBIE DIP**

Our dipped boilies ensure even faraway fish are drawn to the bait thanks to the dip ingredients, which permeate the water perfectly in all temperatures. The natural fruity flavour triggers fish to feed, particularly in the summer months. Dipped baits are proven more successful on over-fished waters and in difficult conditions!

Code	Contents
3950 010	150 ml

Trade Pack 6 Pieces



including flavour capsule

**YELLOW ZOMBIE POP UP'S**

Firm Pop-Ups, suitable for use with the Radical Yellow Zombie Range, which float for a particularly long time. Each tube comes with two different diameters ensuring you can always make the right choice of pop-up for the conditions. Flavour capsule included to boost the pop ups.

Code	Ø	Contents
3943 010	16 mm / 20 mm	75 g

Trade Pack 6 Pieces



including flavour capsule

**YELLOW ZOMBIE NEON POP UP'S**

When you want to light up your pop-ups, fluorescent colours are ideal. Now there is a Neon Pop-Up boilie to match the Yellow Zombie. Colour: fluorescent yellow.

Code	Ø	Contents
3943 053	16 mm / 20 mm	75 g

Trade Pack 6 Pieces



**YELLOW ZOMBIE NEON POWDER**

Ultra-clever option for giving boilies a 'second skin' for additional attraction. Simply roll the wet boilie in the powder – and you're ready! The gel-like shell entices fish with its striking colour and intensive aroma

Code	Weight
3949 017	50 g

Trade Pack 6 Pieces



**STICKER**

Code	Model	Width	Height
9949 014	Yellow Zombie	14,5 cm	9,5 cm

Trade Pack 10 Pieces



**MARBLE SPRAY**

This spray impregnates baits and particles with the precise flavours of our Radical-Boilies. This increases their attractiveness tremendously.

Code	Model	Contents
3949 026	Yellow Zombie	100 ml

Trade Pack 6 Pieces







Resealable bags!

### PINK TUNA BOILIE

Pink and fishy – those are the attributes of our high-end boilie variety. At times during testing, our team anglers were overrun with carp. Whether in southern France in high temperatures or late autumn in Germany, the Pink Tuna will impress with its incredible attraction in any water temperature. Why is that? The mixture of high-quality, protein-rich basic components is enhanced phenomenally with fish meal. The striking colour also makes carp curious. The result? Continuous buzzing from your bite alarms! Special long-session boilie, high level of attraction despite remaining on the hair rig for long periods.

Code	Ø	Contents
3957 001	16 mm	1 kg
3957 002	20 mm	1 kg
3957 003	24 mm	0,8 kg

Supplied as: 6 bags of each type in package.  
Trade Pack 6 Pieces



Resealable bags!



### METHOD MARBLES

Small 9mm versions of our renowned Radical-Boilies open up the range to other coarse anglers. Outstanding for barbel and tench, for example, as well as method feeder fishing.

Code	Model	Ø	Contents	Action
3962 105	Pink Tuna	9 mm	75 g	sinking

Trade Pack 6 Pieces



### METHOD DUMBLE

Small 8x10 mm Dumble versions of our renowned Radical-Boilies open up the range to other coarse anglers. Outstanding for barbel and tench, for example, as well as method feeder fishing.

Code	Model	Ø	Contents	Action
3962 605	Pink Tuna	8 mm / 10 mm	75 g	sinking

Trade Pack 6 Pieces



### PINK TUNA DIP

The unmistakable aroma combined with the solubility of the alcohol make this dip truly special. The dip works quickly, attracting fish into the swim in no time at all. Our tip: Treat a large amount of boilies with Pink Tuna Dip before first feeding in the target area. This will bring fish into the swim in no time.

Code	Contents
3949 003	150 ml

Trade Pack 6 Pieces



including flavour capsule

### PINK TUNA POP UP'S

Firm pop-up boilies that retain their buoyancy for a long period. Perfect for use with Pink Tuna Boilies. Each tube comes with two different diameters ensuring you can always make the right choice of pop-up for the conditions. Flavour capsule included to boost the pop ups.

Code	Ø	Contents
3949 001	16 mm / 20 mm	75 g

Trade Pack 6 Pieces

### PINK TUNA PILLOW

Pink and fishy – those are the attributes of our high-end boilie variety. At times during testing, our team anglers were overrun with carp. Whether in southern France in high temperatures or late autumn in Germany, the Pink Tuna will impress with its incredible attraction in any water temperature. Why is that? The mixture of high-quality, protein-rich basic components is enhanced phenomenally with fish meal. The striking colour also makes carp curious. The result? Continuous buzzing from your bite alarms! Special long-session boilie, high level of attraction despite remaining on the hair rig for long periods.

Code	Size	Contents
3957 008	20 x 20 mm	1 kg

Supplied as: 6 bags of each type in package.  
Trade Pack 6 Pieces



### MARBLE SPRAY

This spray impregnates baits and particles with the precise flavours of our Radical-Boilies. This increases their attractiveness tremendously.

Code	Model	Contents
3949 027	Pink Tuna	100 ml

Trade Pack 6 Pieces



including flavour capsule

### PINK TUNA NEON POP UP'S

When you want to light up your pop-ups, fluorescent colours are ideal. Now there is a Neon Pop-Up boilie to match the Pink Tuna. Colour: Neon pink.

Code	Ø	Contents
3949 002	16 mm / 20 mm	75 g

Trade Pack 6 Pieces



### PINK TUNA NEON POWDER

Ultra-clever option for giving boilies a 'second skin' for additional attraction. Simply roll the wet boilie in the powder – and you're ready! The gel-like shell entices fish with its striking colour and intensive aroma

Code	Weight
3949 019	50 g

Trade Pack 6 Pieces



### STICKER

Code	Model	Width	Height
9949 016	Pink Tuna	14,5 cm	9,5 cm

Trade Pack 10 Pieces



kompletný cenník na [www.SPORTS.sk](http://www.SPORTS.sk), výhradný distribútor pre SR: SPORTS s.r.o.





Resealable bags!

### VAMPIRE GARLIC BOILIE

Garlic has been an absolute secret to success for many years. In this boilie, we have combined the crisp taste of garlic with fresh mint. This combination sends the carp into a frenzy! Just as they did with the Pink Tuna, our field testers also achieved incredible catches with the Vampire Garlic. This boilie would strike fear into Dracula but carp just love it! Protein meal has been used as a base to produce a high-nutrient-value bait. The boilie will tempt large specimens both during short-term sessions and over more prolonged feeding campaigns.

Code	Ø	Contents
3958 001	16 mm	1 kg
3958 002	20 mm	1 kg
3958 003	24 mm	0,8 kg

Supplied as: 6 bags of each type in package.  
Trade Pack 6 Pieces



Resealable bags!



### METHOD MARBLES

Small 9mm versions of our renowned Radical-Boilies open up the range to other coarse anglers. Outstanding for barbel and tench, for example, as well as method feeder fishing.

Code	Model	Ø	Contents	Action
3962 106	Vampire Garlic	9 mm	75 g	sinking

Trade Pack 6 Pieces



### METHOD DUMBLE

Small 8x10 mm Dumble versions of our renowned Radical-Boilies open up the range to other coarse anglers. Outstanding for barbel and tench, for example, as well as method feeder fishing.

Code	Model	Ø	Contents	Action
3962 606	Vampire Garlic	8 mm / 10 mm	75 g	sinking

Trade Pack 6 Pieces



### VAMPIRE GARLIC DIP

Vampire Garlic Dip is alcohol-based and contains real garlic and liquid mint. The dip soaks into the boilies and pop-ups, releasing its flavour over a longer period. The alcohol and resulting solubility of the dip also make it ideal for use in winter.

Code	Contents
3949 012	150 ml

Trade Pack 6 Pieces



including flavour capsule

### VAMPIRE GARLIC POP UP'S

Firm pop-up boilie with long-lasting buoyancy, perfectly suited to the Vampire Garlic Boilie. Each tube comes with two different diameters ensuring you can always make the right choice of pop-up for the conditions. Flavour capsule included to boost the pop ups.

Code	Ø	Contents
3949 010	16 mm / 20 mm	75 g

Trade Pack 6 Pieces



including flavour capsule

### VAMPIRE GARLIC NEON POP UP'S

When you want to light up your pop-ups, fluorescent colours are ideal. Now there is a Neon Pop-Up boilie to match the Vampire Garlic. Colour: Neon white.

Code	Ø	Contents
3949 011	16 mm / 20 mm	75 g

Trade Pack 6 Pieces



### VAMPIRE GARLIC NEON POWDER

Ultra-clever option for giving boilies a 'second skin' for additional attraction. Simply roll the wet boilie in the powder – and you're ready! The gel-like shell entices fish with its striking colour and intensive aroma

Code	Weight
3949 015	50 g

Trade Pack 6 Pieces

### VAMPIRE GARLIC PILLOW

Garlic has been an absolute secret to success for many years. In this boilie, we have combined the crisp taste of garlic with fresh mint. This combination sends the carp into a frenzy! Just as they did with the Pink Tuna, our field testers also achieved incredible catches with the Vampire Garlic. This boilie would strike fear into Dracula but carp just love it! Protein meal has been used as a base to produce a high-nutrient-value bait. The boilie will tempt large specimens both during short-term sessions and over more prolonged feeding campaigns.

Code	Size	Contents
3958 008	20 x 20 mm	1 kg

Supplied as: 6 bags of each type in package.  
Trade Pack 6 Pieces



### STICKER

Code	Model	Width	Height
9949 017	Vampire Garlic	14,5 cm	9,5 cm

Trade Pack 10 Pieces



### MARBLE SPRAY

This spray impregnates baits and particles with the precise flavours of our Radical-Boilies. This increases their attractiveness tremendously.

Code	Model	Contents
3949 028	Vampire Garlic	100 ml

Trade Pack 6 Pieces







Resealable bags!

**BLOODY CHICKEN BOILIE**

These "Radical Bloody amazing" boilies have been developed over countless hours of trials by Quantum Radical team members during the 2009-10 season. German carp ace Benjamin Gründer played a major role in arriving at the perfect blend of ingredients to catch the huge European carp. The ingredients of Radical Bloody Chicken have instant impact with the rapid release of its unique set of attractants. In tests it was found that big fish immediately recognised its meaty flavour and there was no need to pre-bait or "train" fish onto this boilie! The Radical Bloody Chicken is based around a top quality meat base mix, which both promotes digestion, and therefore stimulates more feeding. This contributes to its extremely high levels of attraction. Easily digested and relatively quick to break down in water, the boilie can be used all-year-round and loosed generously without polluting the water.

Code	Ø	Contents
3954 008	16 mm	1 kg
3955 008	20 mm	1 kg
3956 008	24 mm	1 kg

Supplied as: 6 bags of each type in package.  
Trade Pack 6 Pieces



Resealable bags!



**METHOD MARBLES**

Small 9mm versions of our renowned Radical-Boilies open up the range to other coarse anglers. Outstanding for barbel and tench, for example, as well as method feeder fishing.

Code	Model	Ø	Contents	Action
3962 107	Bloody Chicken	9 mm	75 g	sinking

Trade Pack 6 Pieces



**METHOD DUMBLE**

Small 8x10 mm Dumble versions of our renowned Radical-Boilies open up the range to other coarse anglers. Outstanding for barbel and tench, for example, as well as method feeder fishing.

Code	Model	Ø	Contents	Action
3962 607	Bloody Chicken	8 mm / 10 mm	75 g	sinking

Trade Pack 6 Pieces



**BLOODY CHICKEN DIP**

The matching dip for Radical Radical Bloody Chicken Boilies with a cod liver oil base. Highly effective chicken aroma and long lasting attractive effect. Ideal for giving the Radical Bloody Chicken Boilie an extra boost.

Code	Contents
3950 008	150 ml

Trade Pack 6 Pieces



including flavour capsule

**BLOODY CHICKEN POP UP'S**

Firm pop-up boilies that retain their buoyancy for a long period. Perfect for use with Radical Bloody Chicken Boilies. Each tube comes with two different diameters ensuring you can always make the right choice of pop-up for the conditions. Flavour capsule included to boost the pop ups.

Code	Ø	Contents
3943 008	16 mm / 20 mm	75 g

Trade Pack 6 Pieces



including flavour capsule

**BLOODY CHICKEN NEON POP UP'S**

When you want to light up your pop-ups, fluorescent colours are ideal. Now there is a Neon Pop-Up boilie to match the Bloody Chicken. Colour: fluorescent red.

Code	Ø	Contents
3943 050	16 mm / 20 mm	75 g

Trade Pack 6 Pieces



**BLOODY CHICKEN NEON POWDER**

Ultra-clever option for giving boilies a „second skin“ for additional attraction. Simply roll the wet boilie in the powder – and you're ready! The gel-like shell entices fish with its striking colour and intensive aroma

Code
3949 018

Trade Pack 6 Pieces

**BLOODY CHICKEN PILLOW**

These "Radical Bloody amazing" boilies have been developed over countless hours of trials by Quantum Radical team members during the 2009-10 season. German carp ace Benjamin Gründer played a major role in arriving at the perfect blend of ingredients to catch the huge European carp. The ingredients of Radical Bloody Chicken have instant impact with the rapid release of its unique set of attractants. In tests it was found that big fish immediately recognised its meaty flavour and there was no need to pre-bait or "train" fish onto this boilie! The Radical Bloody Chicken is based around a top quality meat base mix, which both promotes digestion, and therefore stimulates more feeding. This contributes to its extremely high levels of attraction. Easily digested and relatively quick to break down in water, the boilie can be used all-year-round and loosed generously without polluting the water.

Code	Size	Contents
3955 013	20 x 20 mm	1 kg

Supplied as: 6 bags of each type in package.  
Trade Pack 6 Pieces



**STICKER**

Code	Model	Width	Height
9949 013	Bloody Chicken	14,5 cm	9,5 cm

Trade Pack 10 Pieces



**MARBLE SPRAY**

This spray impregnates baits and particles with the precise flavours of our Radical-Boilies. This increases their attractiveness tremendously.

Code	Model	Contents
3949 029	Bloody Chicken	100 ml

Trade Pack 6 Pieces

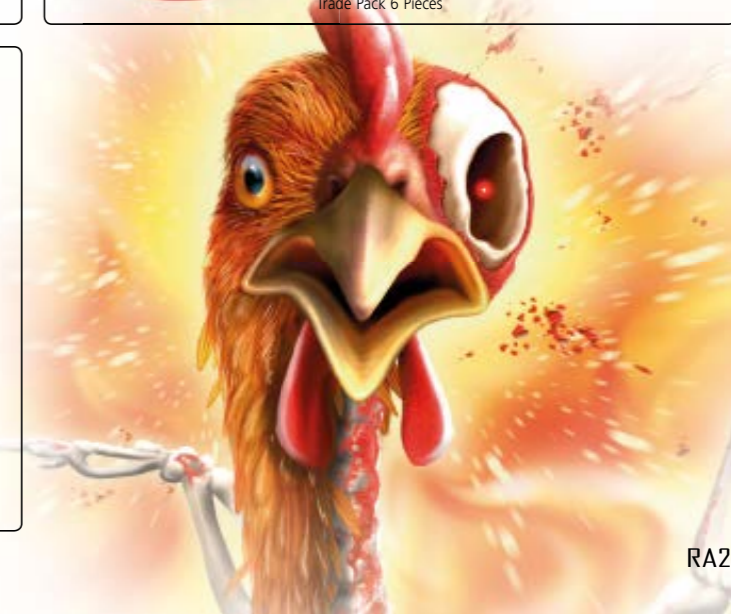





Contents not included!

**BOILIE PRESENTATION GLASS FIGURINE. RADICAL**

Attractive counter display for presenting Radical-Boilies. With cover. Material: Glass

Code	Weight	Contents
9963 016	1150 g	1,7l



**BOILIE SHELFDISPLAY. RADICAL**

Easy to assemble shop display made from robust, printed cardboard for up to 6 stand-up bags from the attractive Quantum boilie range. Improves sales enormously. Boilies not included.

Code
9963 015



**ENERGY PARTICLES**

No particle is accepted so readily by carp as the tiger nut. Carp love tiger nuts! Whether this irresistible bait is fed in plain or flavoured form, one thing is certain: carp go into an absolute frenzy when they eat tiger nuts. Our team uses flavoured varieties for rapid attraction but prefer to use natural nuts on longer trips. A perfect complement to our Tiger's Nuts Boilie.

Contents	Nature natural	Sweet Fruit yellow	Shrimp & Oyster brown	Nature XXL natural
710 ml	3801 001			
710 ml		3801 002	3801 003	3801 004

Trade Pack 6 Pieces



RA30



RA31

kompletný cenník na [www.SPORTS.sk](http://www.SPORTS.sk), výhradný distribútor pre SR: SPORTS s.r.o.





**BASILISK MAIN LINE**

Extremely durable, red-tinted, high quality specimen line. As good as invisible in the water, since red is one of the first colours to disappear beneath the surface, but extremely strong due to its special molecular structure and elaborate stretching process.

Code	Ø	Length	BS
2615 033	0,33 mm	300 m	7,5 kg / 16,5 lbs
2615 035	0,35 mm	300 m	9,1 kg / 20,1 lbs
2615 040	0,40 mm	300 m	10,8 kg / 23,8 lbs

Trade Pack 3 Pieces



**BASILISK MAIN LINE**

Extremely durable, red-tinted, high quality specimen line. As good as invisible in the water, since red is one of the first colours to disappear beneath the surface, but extremely strong due to its special molecular structure and elaborate stretching process.

Code	Ø	Length	BS
2615 130	0,30 mm	1800 m	6,6 kg / 14,6 lbs
2615 133	0,33 mm	1800 m	7,5 kg / 16,6 lbs
2615 140	0,40 mm	1800 m	10,8 kg / 23,8 lbs



**BASILISK CARP BRAID**

The Basilisk Carp Braid represents absolute perfection. When it comes to modern long-range angling, high-quality braids are an absolute must! Big fish at long distances is what the Basilisk Carp Braid is all about! A perfect combination of high durability, high breaking strain, high knot strength, minimal buoyancy and practically stretch-free with no bleaching of the line colour by the UV light.

Code	Ø	Length	BS	Colour
2313 025	0,23 mm	350 m	11,3 kg / 25 lbs	red
2313 030	0,26 mm	350 m	13,6 kg / 30 lbs	red
2313 035	0,28 mm	350 m	15,9 kg / 35 lbs	red
2314 025	0,23 mm	350 m	11,3 kg / 25 lbs	green
2314 030	0,26 mm	350 m	13,6 kg / 30 lbs	green
2314 035	0,28 mm	350 m	15,9 kg / 35 lbs	green

Trade Pack 3 Pieces



**BASILISK CARP BRAID**

The Basilisk Carp Braid represents absolute perfection. When it comes to modern long-range angling, high-quality braids are an absolute must! Big fish at long distances is what the Basilisk Carp Braid is all about! A perfect combination of high durability, high breaking strain, high knot strength, minimal buoyancy and practically stretch-free with no bleaching of the line colour by the UV light.

Code	Ø	Length	BS	Colour
2313 125	0,23 mm	1400 m	11,3 kg / 25 lbs	red
2313 130	0,26 mm	1400 m	13,6 kg / 30 lbs	red
2313 135	0,28 mm	1400 m	15,9 kg / 35 lbs	red
2314 125	0,23 mm	1400 m	11,3 kg / 25 lbs	green
2314 130	0,26 mm	1400 m	13,6 kg / 30 lbs	green
2314 135	0,28 mm	1400 m	15,9 kg / 35 lbs	green



**BASILISK FORCE LINK**

Our team has introduced this extremely durable and yet soft material in the new range. The leader material is perfectly suited to fishing with anti-blow-out rigs and line-aligner rigs. The fish barely stands a chance of shaking the hook out.

Code	Length	BS
2647 015	20 m	6,8 kg / 15 lbs
2647 020	20 m	9,1 kg / 20 lbs
2647 025	20 m	11,3 kg / 25 lbs
2647 035	20 m	15,9 kg / 35 lbs

Trade Pack 5 Pieces



**BASILISK COMBI LINK**

Combi-links are practical. Simply peel off a couple of centimetres of the soft coating and you already have a leader soft enough to outfit even the most wary fish without tangling in strong currents or on long casts.

Code	Length	BS
2644 015	15 m	6,8 kg / 15 lbs
2644 020	15 m	9,1 kg / 20 lbs
2644 025	15 m	11,3 kg / 25 lbs

Trade Pack 5 Pieces



**BASILISK HOOK LINK**

This leader can be used in 99% of all situations. It is made from a braided material with just the right softness that it can be taken by fish without resistance. An absolute all-round talent among carp leaders.

Code	Length	BS
2646 015	20 m	6,8 kg / 15 lbs
2646 020	20 m	9,1 kg / 20 lbs
2646 025	20 m	11,3 kg / 25 lbs
2646 035	20 m	15,9 kg / 35 lbs

Trade Pack 5 Pieces



**BASILISK POWER KOMBI LINK**

A combi-leader with the strength of an ox. Our team developed this leader material for harsh angling conditions on large rivers on stone packing or on large stillwaters with an abundance of deadwood.

Code	Length	BS
2648 025	15 m	11,3 kg / 25 lbs
2648 030	15 m	13,6 kg / 30 lbs
2648 040	15 m	18,1 kg / 40 lbs

Trade Pack 5 Pieces



**BASILISK LEAD CORE**

When it comes to catching cautious fish, the line has to lie tight to the bottom. Our leadcore sinks reliably to the bottom of the water so that cautious fish are no longer spooked. Leadcore also offers protection from abrasion against mussels, stones and wood.

Code	Length	BS
2649 025	8 m	11,3 kg / 25 lbs
2649 040	8 m	18,1 kg / 40 lbs

Trade Pack 5 Pieces



**BASILISK CARBON HOOKLINE**

On clear waters, it is important that the angler is as cautious as the fish! This is where the almost invisible Carbon Hookline comes into its own. The material is also the absolute first choice when making stiff rigs.

Code	Length	BS
2650 025	20 m	11,3 kg / 25 lbs
2650 030	20 m	13,6 kg / 30 lbs
2650 040	20 m	18,1 kg / 40 lbs

Trade Pack 5 Pieces





**BASILISK LEAD CORE QUICK SNAP**  
Leadcore rig, release clip and quick-release swivel.

Code	Length	BS	Content	Colour
4365 061	60 cm	40 lbs / 18 kg	2 pcs	green
4365 101	100 cm	40 lbs / 18 kg	2 pcs	green

Trade Pack 10 Pieces



**BASILISK LEAD CORE SPLIT RING**  
Leadcore rig, release clip and bent head oval split ring.

Code	Length	BS	Content	Colour
4365 062	60 cm	40 lbs / 18 kg	2 pcs	green
4365 102	100 cm	40 lbs / 18 kg	2 pcs	green

Trade Pack 10 Pieces



**WEEDY LEADER**  
Low-stock waters often harbour very big carp. However, these are usually difficult to catch. This makes camouflage an utmost priority. Our Radical Weedy Leaders look so amazingly authentic that, for a moment, we were speechless. Tests on the water showed that the material is practically indistinguishable from real foliage and aquatic plants. The material is also extremely durable. Sharp edges from shells or stones have no effect. Our tests showed that bite numbers increased dramatically. Available in 2 colours and with different rig connectors.

Code	Length	Colour
4347 001	100 cm	green
4347 002	100 cm	brown
4347 101	100 cm	green
4347 102	100 cm	brown

Trade Pack 10 Pieces



**BASILISK MONO SHOCK LEADER**  
Sharp stones, mussels and deadwood make a strong leader indispensable. The Radical Shockleader comprises extremely durable nylon, which was honed on the largest rivers in Central Europe during testing. 101% reliable and equipped for the "most radical" uses.

Code	Ø	Length	BS
2699 050	0,50 mm	80 m	18 kg / 40 lbs
2699 060	0,60 mm	80 m	22 kg / 48 lbs

Trade Pack 5 Pieces



**BASILISK SUPER SOFT CARP RIG**  
Basilisk Super Soft Carp Rig  
Developed for cautious fish, with ultra-soft braid and fast-rotating hook

Code	Hook Size	BS
4216 002	2	15 kg / 35 lbs
4216 004	4	15 kg / 35 lbs
4216 006	6	11 kg / 25 lbs
4216 008	8	11 kg / 25 lbs

Trade Pack 10 Pieces



**BASILISK SINKING CARP RIG**  
Basilisk Sinking Carp Rig  
The standard rig for a range of situations. The rig accounted for by far the most fish over the year for our team.

Code	Hook Size	BS
4217 002	2	15 kg / 35 lbs
4217 004	4	15 kg / 35 lbs
4217 006	6	11 kg / 25 lbs
4217 008	8	11 kg / 25 lbs

Trade Pack 10 Pieces



**BASILISK SPECIMEN COMBI RIG**  
Basilisk Specimen Combi Rig  
For long casts, when on a ship or when faced with armies of crabs. The front end is so soft that the fish barely feels any resistance, while the rear end is torsion-resistant.

Code	Hook Size	BS
4218 002	2	15 kg / 35 lbs
4218 004	4	15 kg / 35 lbs
4218 006	6	11 kg / 25 lbs
4218 008	8	11 kg / 25 lbs

Trade Pack 10 Pieces



**BASILISK BOILIE RIG**  
Basilisk Boilie Rig  
Equipped with a classic boilie hook, the rig can be used with boilies of all sizes. A true all-rounder for rivers, lakes and ponds!

Code	Hook Size	BS
4219 002	2	15 kg / 35 lbs
4219 004	4	15 kg / 35 lbs
4219 006	6	11 kg / 25 lbs
4219 008	8	11 kg / 25 lbs

Trade Pack 10 Pieces



**BASILISK SNOWMAN RIG**  
Basilisk Snowman Rig  
Pop-up rigs are in vogue, but only the right rig will set the hook reliably. The Basilisk SR works consistently and hooks fish after fish.

Code	Hook Size	BS
4224 002	2	15 kg / 35 lbs
4224 004	4	11 kg / 25 lbs
4224 006	6	7 kg / 15 lbs
4224 008	8	7 kg / 15 lbs

Trade Pack 10 Pieces



**HELI RIG**

Code	Length	Content
6611 029	40 cm	3 pcs

Trade Pack 10 Pieces





**CARP WIDE GAPE**

Code	Hook Size	Content	Colour
4415 002	2	10 pcs	titan x
4415 004	4	10 pcs	titan x
4415 006	6	10 pcs	titan x
4415 008	8	10 pcs	titan x
4415 010	10	10 pcs	titan x

Trade Pack 5 Pieces

**CARP CONTINENTAL STRONG**

Code	Hook Size	Content	Colour
4416 002	2	10 pcs	titan x
4416 004	4	10 pcs	titan x
4416 006	6	10 pcs	titan x
4416 008	8	10 pcs	titan x

Trade Pack 5 Pieces

**CARP CHODDA SPECIAL**

Code	Hook Size	Content	Colour
4417 002	2	10 pcs	titan x
4417 004	4	10 pcs	titan x
4417 006	6	10 pcs	titan x
4417 008	8	10 pcs	titan x

Trade Pack 5 Pieces

**CARP CURVE SHANK ELITE**

Code	Hook Size	Content	Colour
4418 002	2	10 pcs	titan x
4418 004	4	10 pcs	titan x
4418 006	6	10 pcs	titan x
4418 008	8	10 pcs	titan x
4418 010	10	10 pcs	titan x

Trade Pack 5 Pieces

**LONGSHANK MICRO BARB**

Code	Hook Size	Content	Colour
4419 002	2	10 pcs	titan x
4419 004	4	10 pcs	titan x
4419 006	6	10 pcs	titan x
4419 008	8	10 pcs	titan x

Trade Pack 5 Pieces

**WEED HOOK**

Code	Hook Size	Content	Colour
4442 002	2	10 pcs	titan x
4442 004	4	10 pcs	titan x
4442 006	6	10 pcs	titan x
4442 008	8	10 pcs	titan x

Trade Pack 5 Pieces

**ANTI TANGLE SAFETY CLIP**

A complete 100% suitable safety clip system with anti-tangle tubes for long casts – assembled by the team with the finest materials.

Code	Content	Colour
6000 001	40 pcs	green

Trade Pack 10 Pieces

**SAFETY CLIP SYSTEM**

Safety clip systems belong in every tackle box. The Radical system is perfectly harmonised and hooks every fish securely. It also impresses with its price-performance ratio.

Code	Content	Colour
6000 002	30 pcs	green

Trade Pack 10 Pieces

**FAKEBAITS**

Lures are extremely successful and always ready to use. Our Fakebaits are made from a rubber compound that neither fades nor smells of chemicals. An absolute top bait whether used alone or combined with our attractive boilies.

Code	Content
3890 999	25 pcs

Trade Pack 10 Pieces

**TUNGSTEN TUBE**

Code	Length	Ø
6611 001	50 cm	0,60 mm / 1,85 mm

pro m  
Trade Pack 10 Pieces

**SILICONE TUBE**

Code	Length	Ø
6611 002	1 m	0,80 - 1,80 mm
6611 003	1 m	1,00 - 2,00 mm

Trade Pack 10 Pieces

**EVA POP UP'S**

Pop-up baits are indispensable in many situations. As a single hookbait, pop-ups create a fast bite as a Snowman bait on soft bottoms, they offer perfect balance. The striking colours appeal to the carp's curiosity. Sizes: 10, 14, 16 and 20 mm. Colours: yellow, pink, white, orange, green, brown, red.

Code	Content	Ø
6783 013	15 pcs	10 mm / 14 mm
6783 011	15 pcs	16 mm / 20 mm

Trade Pack 10 Pieces

**POP UP FOAM**

orange, brown, yellow

Code	Length	Content	Ø
6783 010	10 cm	3 pcs	10 mm

Trade Pack 10 Pieces

**POP UP FOAM**

white, green, pink

Code	Length	Content	Ø
6783 012	10 cm	3 pcs	10 mm

Trade Pack 10 Pieces



kompletný cenník na [www.SPORTS.sk](http://www.SPORTS.sk), výhradný distribútor pre SR: SPORTS s.r.o.





**SAFETY CLIPS W. PIN**

Code	Content	Colour
6611 054	10 pcs	mat green

Trade Pack 10 Pieces



**TAIL RUBBER**

Code	Length	Content	Colour
6611 055	20 mm	10 pcs	transparent
6611 056	20 mm	10 pcs	sand

Trade Pack 10 Pieces



**METAL SAFETY CLIP**

Code	Content	Colour
6611 026	10 pcs	mat green

Trade Pack 10 Pieces



**ROLLING SWIVEL**

Code	Length	Size	Content
6124 003	17 mm	3	10 pcs
6124 004	15 mm	4	10 pcs
6124 005	14 mm	5	10 pcs

Trade Pack 10 Pieces



**BENT HEAD OVAL SPLIT RING**

Code	Length	Size
6110 001	13 mm	4

Trade Pack 10 Pieces



**HELI SWIVEL**

Code	Length	Size	Content
6118 007	15 mm	7	7 pcs

Trade Pack 10 Pieces



**ANTI-TANGLE SLEEVES**

Code	Length	Content	Colour
6611 060	40 mm	10 pcs	green
6611 061	40 mm	10 pcs	sand
6611 062	40 mm	10 pcs	brown

Trade Pack 10 Pieces



**SHRINK TUBE**

Code	Length	Ø	Colour
6611 012	1,0 m	1,5 mm	green
6611 013	1,0 m	2,0 mm	green
6611 015	1,0 m	3,0 mm	green

Trade Pack 10 Pieces



**KICKER ALIGNER**

Code	Length	Content
6614 001	12 mm	10 pcs

Trade Pack 10 Pieces



**ROUND RIG RING**

Code	Ø	Content
6168 002	3,1 mm	10 pcs

Trade Pack 10 Pieces



**LEAD SHOT IN DIFFERENT SIZES. OVAL**

Rather than using round lead shot for pop-up rigs, oval split-shots distribute weight significantly better, allowing rigs to be balanced more precisely.

Code	Content
6100 004	22 pcs

Trade Pack 10 Pieces



**BENT HOOK ALIGNER**

Code	Length	Content
6614 002	18 mm	10 pcs

Trade Pack 10 Pieces



**SIT UP ALIGNER**

Code	Length	Content
6614 003	29 mm	10 pcs

Trade Pack 10 Pieces



**WITHY POOL RIG ALIGNER**

Code	Length	Content
6614 004	28 mm	10 pcs

Trade Pack 10 Pieces



**RADICAL COMBAT UNIT II**

A well designed tackle box for storing a multitude of various smaller boxes and leader dispensers. The box holds everything an experienced carp angler could want at the water's edge. Quick release clips ensure easy opening and closing, particularly of benefit when you have cold hands. To complete the range, there are matching small accessory boxes available. The large basic box comes with 4 big and 2 small accessory boxes.

Code	Model	Width	Height	Depth
8061 022	Combat Unit II	29 cm	23 cm	5 cm

Trade Pack 5 Pieces



**SOFT BEAD**

Code	Ø	Content
6611 058	4,0 mm	50 pcs
6611 059	6,0 mm	50 pcs

Trade Pack 10 Pieces



**CHOD RIG BEADS**

Rubber beads are used for building various rigs, such as the chod rig or helicopter rig, or simply as a fixing from the hair to the hook.

Code	Content	Colour
6614 010	20 pcs	transparent

Trade Pack 10 Pieces



**TUNGSTEN PUTTY**

Code	Weight	Content	Colour
6611 000	15 g	1 pcs	green
6611 009	15 g	1 pcs	brown

Trade Pack 5 Pieces



**SOLID RIG CASE**

Hard shell case for storing leaders in stretched out form.

Code	Width	Height	Depth
8061 014	34,4 cm	9,5 cm	4,7 cm

Trade Pack 5 Pieces







**FLEXI BACK LEAD**

Code	Weight	Content
6092 020	20 g	2 pcs
6092 030	30 g	2 pcs
6092 050	50 g	2 pcs

Trade Pack 5 Pieces



**TRILOBE LEAD**

Code	Weight	Colour
6089 040	40 g	dark green
6089 060	60 g	dark green
6089 080	80 g	dark green
6089 100	100 g	dark green
6089 120	120 g	dark green
6089 140	140 g	dark green

Trade Pack 10 Pieces



**DISTANCE LEAD**

Code	Weight	Colour
6176 003	113 g	gravel
6176 004	142 g	gravel

Trade Pack 10 Pieces



**FLAT DISTANCE LEAD**

Code	Weight	Colour
6178 001	57 g	gravel
6178 002	85 g	gravel
6178 003	113 g	gravel

Trade Pack 10 Pieces



**HIGH GRIP LEAD**

Code	Weight	Colour
6180 001	85 g	gravel
6180 002	113 g	gravel
6180 004	170 g	gravel
6180 005	227 g	gravel

Trade Pack 10 Pieces



**MULTIFUNCTION TOOL**

Code  
6602 021

Trade Pack 5 Pieces



**BOILIE DRILL**

Code	Length	Content
6626 001	55 mm	1 pcs

Trade Pack 10 Pieces



**SPLICING NEEDLE**

Code	Length	Content
6626 002	55 mm	1 pcs

Trade Pack 10 Pieces



**BOILIE NEEDLE**

Code	Length	Content
6626 003	55 mm	1 pcs

Trade Pack 10 Pieces



**PARTICLE NEEDLE**

Code	Length	Content
6626 004	55 mm	1 pcs

Trade Pack 10 Pieces



**STICK NEEDLE**

Code	Length	Content
6626 005	110 mm	1 pcs

Trade Pack 10 Pieces

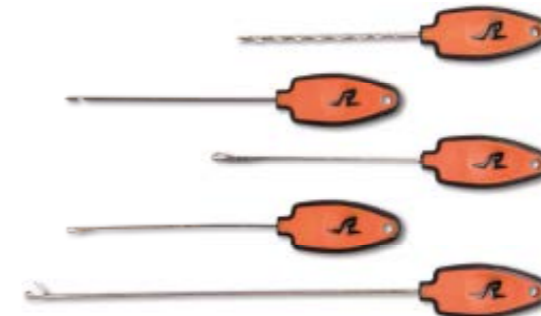

**NEEDLE SET**

This needle set comprises the most popular needles for attaching baits to the hair or splicing leadcore.

Code	Content
6626 999	5 pcs

Trade Pack 5 Pieces



**KNOT PULLER**

Code  
6602 022

Trade Pack 10 Pieces





**BRAID CUTTER WITH HOOK SHARPENER**

Code	Length
6409 005	13,5 cm

Trade Pack 5 Pieces



**BOILIE NEEDLE SET**

Code	Content
6600 998	Trade Pack 10 Pieces



**PVA STRING**

Soluble bag with the precise dissolving speed requested by professional carp anglers. Enables pellets, particles and boilies to be fed directly around the hook.

Code	Length	Ø
2604 001	50 m	25 mm
2604 002	50 m	

Trade Pack 10 Pieces



**PVA TAPE**

Our PVA Tape dissolves rapidly and is perfect for sealing PVA bags. Quick and easy to tie, the Radical PVA Tape can also be used for casting out rigs in loops without tangling.

Code	Length	Width
2604 003	10 m	10 mm

Trade Pack 10 Pieces



**BAIT STOPPER**

Code	Content	Colour
6605 030	3 pcs	transparent
6605 031	3 pcs	brown

Trade Pack 10 Pieces



**BOILIE STOPPER**

Code	Content	Colour
6605 011	3 pcs	transparent

Trade Pack 10 Pieces



**PVA MESH TUBE**

Soluble bag with the precise dissolving speed requested by professional carp anglers. Enables pellets, particles and boilies to be fed directly around the hook.

Code	Length	Ø
2605 000	5 m	20 mm
2605 001	5 m	25 mm
2605 002	5 m	37 mm

Trade Pack 5 Pieces



**MULTIBAITER ALU**

Indestructible metal version of the bait scoops for feeding particles and boilies.

Code
8177 000

Trade Pack 5 Pieces



**BOILIE STOPPER**

Code	Content	Colour
6605 013	3 pcs	black

Trade Pack 10 Pieces



**BOILIE STOPPER**

Code	Content	Colour
6605 014	3 pcs	yellow

Trade Pack 10 Pieces



**MULTIBAITER HANDLE**

Handle for screwing onto a bait scoop.

Code	Length
8177 999	30 cm

Trade Pack 5 Pieces



**MULTIBAITER**

The well known multibaiter is now available from Radical. Now, feeding your swim with large amounts of bait can be child's play. The spoon is screwed onto a landing net handle and features slits which allow water to escape from the bait container.

Code
8177 001

Trade Pack 5 Pieces

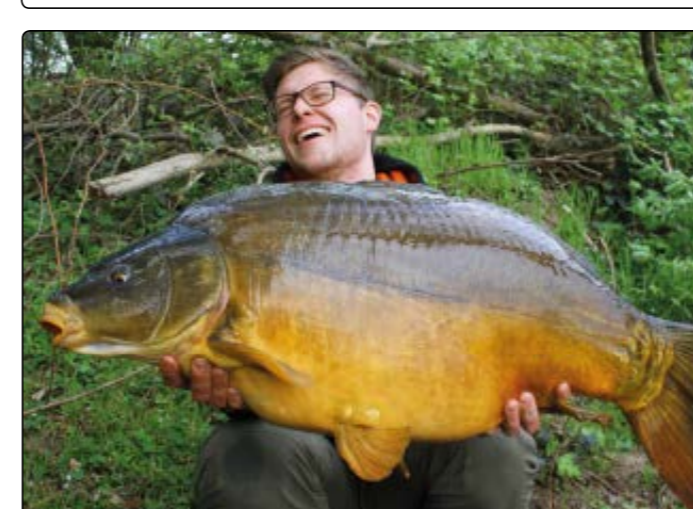



**BAIT SPOON KIT**

Code	Size
8177 009	M

Trade Pack 5 Pieces





**BOILIE SHOOTER**

Carp often feed in very remote areas. Our Boilieshooter allows you to feed boilies with extreme precision over distances of up to 120 metres. The Shooter sits easily in the hand and is a highly precise weapon for creating feeding grounds. Material: Alu

Code	Length	Ø	Colour
8177 022	70 cm	16 mm	black
8177 025	75 cm	20 mm	black



**BAIT CRUSHER DELUXE**

Crushed tiger nuts and boilies are now among the absolute top baits on many waters. But breaking down the hard tiger nuts requires the right tool. The Radical Baitcrusher is not only strong but is also ergonomically comfortable in the hands so can generate crushing pressure without too much strain on the wrists.

Code	Width	Height	Colour
6630 002			



**DEEPGROUND MARKER**

Inflatable Radical Deepground Marker. Ultra-compact and inflates in seconds. Highly stable on the water, even in high waves. The Marker can also be used with a stone on the rope, as a detector buoy or breakaway rig in combination with the Radical Knock-Out clip system.

Code	Width	Height	Colour
5570 004	15 cm	15 cm	black/orange

Trade Pack 5 Pieces



**SENSONIC BITE ALARM SET**

The name Sensonic represents extreme sensitivity combined with optimal robustness. The Radical Team invested months of work in developing a bite alarm suited to any angling conditions in Europe. A waterproof circuit board guarantees maximum functionality, the buttons are ergonomic and the design is contemporary. Sensitivity, volume, pitch and the night function are continuously adjustable. The bite indicator has a power output for illuminated hangers. Snag ears secure the rod even on violent bites while the solid stainless steel thread ensures a secure seating on the rod pod. Up to 120-metre reception range. The set includes three bite alarms, one receiver and a hard case. Batteries: 2xAAA (not included).

Code	Content	Colour
6812 999	3+1 pcs	green, yellow, red



**SENSONIC BITE ALARM RECEIVER**

The receiver for the Sensonic bite alarm offers a reception range of up to 120 metres. The volume for a bite is continuously adjustable while an integrated light provides sufficient light when you need to read the rod quickly on a big run. Batteries: 2xAAA (not included).

Code	Width	Height	Depth	Content
6812 005	4,0 cm	9,5 cm	2,6 cm	1 pcs



**SENSONIC BITE ALARM**

The name Sensonic represents extreme sensitivity combined with optimal robustness. The Radical Team invested months of work in developing a bite alarm suited to any angling conditions in Europe. A waterproof circuit board guarantees maximum functionality, the buttons are ergonomic and the design is contemporary. Sensitivity, volume, pitch and the night function are continuously adjustable. The bite indicator has a power output for illuminated hangers. Snag ears secure the rod even on violent bites while the solid stainless steel thread ensures a secure seating on the rod pod. Up to 120-metre reception range. Batteries: 2xAAA (not included).

Code	Width	Height	Depth	Content	Colour
6812 001	4,8 cm	12,0 cm	2,8 cm	1 pcs	green
6812 002	4,8 cm	12,0 cm	2,8 cm	1 pcs	yellow
6812 003	4,8 cm	12,0 cm	2,8 cm	1 pcs	red
6812 004	4,8 cm	12,0 cm	2,8 cm	1 pcs	blue



**AFTER DARK BITE ALARM SET**

For those who want a reliable workhorse but do not want to sacrifice performance, fine, 8-stage settings for sensitivity, pitch and volume, the After Dark is the perfect partner. The Radical Team designers have even included theft protection and snag ears. Maximum range, depending on conditions: 90 m. Batteries: 1x9V (not included).

Code	Content	Colour
6800 999	3+1 pcs	red, green, blue
6800 001	1 pcs	orange

**RADICAL DOUBLE STICK BUZZER**

At 360 g, lighter than any rod pod! The buzzer bar anchors into the ground and accommodates up to 3 rods. It can also be collapsed for transport.

Code	Length
8200 007	65 - 82 cm

**STORM POLE**

Even in tough ground the Storm Pole finds firm hold easily thanks to the screw-in tip. Where other bank sticks are no use the Storm Pole will not let you down!

Code	Length
1834 001	60 cm
1834 002	80 cm
1834 003	100 cm

Trade Pack 5 Pieces

**BANK STICK**

High quality stainless steel rod holder. Adjustable length. Very robust and will not bend.

Code	Length
1833 001	50 - 90 cm

Trade Pack 5 Pieces

**LINE DIVER**

On a drop-back bite, the Line Diver dives down deep and so causes every bite to be indicated. The head incorporates a clip design that holds the line securely without damaging it but releases the line cleanly on every run. The head also has a night-glow function that emits bright colours on even the darkest of nocturnal carp sessions. A 2 oz, continuously adjustable stainless steel cylinder slides along the shaft, ensuring that every bite is seen and heard even when fishing at long range.

Code	Colour
6709 001	green
6709 002	yellow
6709 003	red
6709 004	blue

Trade Pack 5 Pieces

**CARBON BANK STICK**

Completely unique and for true carp anglers. The ultra-light banksticks in extremely robust carbon-fibre material have been tested at the water by our team angler Robin Illner. They were subjected to sharp stones, sand, thick clay, storms, waves and being wet all day. The result: test passed. The carbon-fibre banksticks are also extremely lightweight. Ideal for overnight sessions.

Code	Length
8200 017	50 - 90 cm
8200 018	70 - 130 cm

**CARBON BUZZER BAR**

Completely unique and for true carp anglers. The ultra-light buzzer bars in extremely robust carbon-fibre material have been tested at the water by our team angler Robin Illner. They were subjected to sharp stones, sand, thick clay, storms, waves and being wet all day.

Code	Model	Length
8200 015	3 rods	25 cm
8200 016	2 rods	15 cm

**BITE INDICATOR. DELUXE**

Set up in front of the bite alarm, maintaining line tension and providing visual bite indication.

Code
6711 006

Trade Pack 5 Pieces

**METAL SNAG BAR**

This little accessory reliably prevents the angler's rod from being pulled sideways off his bite alarm, even during strong winds.

Code	Length	Width
6702 001	15 cm	3 cm

Trade Pack 5 Pieces

kompletný cenník na [www.SPORTS.sk](http://www.SPORTS.sk), výhradný distribútor pre SR: SPORTS s.r.o.





**EVA NON-SNAG FEEDER REST**

A rod holder that keeps a firm grasp on your carp rod. The material is soft and rubberised yet powerful enough to hold the blank or rod handle securely. Sorrosion resistant screw thread. Suitable for use on rivers and lakes alike.

Code	Model	Content
1849 010	M	1 pcs
1849 011	S	1 pcs
Trade Pack 10 Pieces		



**ROD REST**

Code	Model	Content
1849 007	M	1 pcs
Trade Pack 10 Pieces		



**HIGH POD REST**

Code	Content
1849 009	1 pcs
Trade Pack 10 Pieces	



**BUTT GRIP STANDARD**

Code	Content
1849 005	1 pcs
Trade Pack 10 Pieces	



**ROD POD FREESTYLE**

Freestyle means to go your own way, which can often be the key to angling. For those anglers with foresight, who fish on numerous different waters, we have developed the four-legged Freestyle pod. The pod is equally suited to both extreme river fishing and long-range sport. With its simple yet solid screw attachments, the rod pod is ready to roll in no time and packs away just as quickly. A true all-rounder. Material: Aluminium. Accessories: Rod Pod Bag.

Code	Length	Height	Weight
8402 022	75 - 130 cm	40 - 64 cm	1,85 kg



**RADICAL DESPERADO BS HOLDALL**

Our Desperado Big Session Holdall provides enough space to transport four rigged up rods to France or Italy. There is even additional room for a further two unrigged rods. The Holdall is a veritable storage miracle. The four rods are no longer packed next to each other but at a 180-degree rotation. This gives the holdall the capacity of a 2+2 holdall, which means it can always fit into even small cars. The robust, thickly-padded side walls and central protective wall ensure your valuable rods are optimally protected. The durable outer pocket also features additional compartments for banksticks, a large umbrella, landing nets and much more besides. Material: 100% Polyester

Code	Length
8511 001	2,10 m



**RADICAL SOLO SLEEVE**

Our thick padded solo sleeves protect any rod safely and reliably against damage. Individual bags can be convenient and hugely practical at times. What angler hasn't had the problem of the car being packed up to the roof? Individual holdalls can be easier to find room for than conventional large multi-holdalls. Available in 3 different lengths for all rod sizes. Material: 100% Nylon

Code	Length
8511 003	1,70 m
8511 004	1,90 m
8511 005	2,10 m

**RADICAL QUICKY QUIVER**

Short, one-night sessions are becoming increasingly popular with many carp anglers. Long-winded packing and unpacking of rods, umbrella, landing net, etc. is not what the angler wants during a short session. The new Quicky Quiver caters specifically for the requirements of the "quick" carp angler without making any compromises. The holdall can accommodate up to four rigged-up rods while also offering room for an umbrella, banksticks and a landing net. A robust mesh side-pocket allows wet items in the holdall to dry out. The Quiver also has ultra-robust eyes and carabiners as well as an individually adjustable strap for highly comfortable carrying. Material: 100% Polyester

Code	Length	Width	Height
8511 014	120 cm	35 cm	15 cm







**RADICAL COMBAT BAG**

With this bag, the carp angler is fully prepared to go into "combat" with the carp. The metal shoulder strap rings guarantee a long life. The bag's base is 100% waterproof while the zips are heavy-duty. One pocket on the front and three on the side complement the amply large main section to provide enough storage space for long trips. • Includes free large tackle box Material: 100% Nylon

Code	Width	Height	Depth
8511 006	60 cm	30 cm	30 cm



**RADICAL BAIT BAG**

A robust folding bucket with a lid, which can be closed with a zip fastener. Whether you want to carry large amounts of boilies, pellets or small accessories - the folding bucket can hold it all. Equipped with two solid carry handles. Material: 100% Nylon

Code	Length	Width	Height
8511 020	35 cm	26 cm	27 cm



**RADICAL BAIT BOWL**

Method feeder fishing continues to grow in popularity. Our Radical Bait Bowl for groundbait folds to a small size but is 100% waterproof and is ideal for short sessions. The bowl is designed not just for method groundbait but also particles or boilies to be fed from the boat. Material: 100% Nylon

Code	Ø
8511 011	20 cm
8511 012	35 cm



**RADICAL GIGANTICA BAG**

Big, bigger, Gigantica! That is the best way we can describe our "monster" from the Radical bag range. Designed to take anything and everything you need to the water whether gas cookers, sleeping bags, tackle bags, rig cases, food or an umbrella overwrap... The Gigantica is not just big, it's also incredibly strong. The metal shoulder strap rings guarantee a long life. The base is 100% waterproof while the zips are all heavy-duty. Complete with two side pockets, two front pockets and an overlap to protect the zip from rain. • Includes free tackle box and rig board!! Material: 100% Nylon

Code	Width	Height	Depth
8511 008	70 cm	30 cm	40 cm



**RADICAL BUCKET**

Leaky buckets are a moderate disaster in the tent or car. The super-tight Radical Bait-Bucket with a 20-litre capacity is not only perfectly suited to transporting baits. Food and clothing can also be stored safe and dry and the bucket is perfectly shaped for storage in the boat and car. Material: 100% Polypropylene

Code	Length	Height	Depth	Colour
8514 002	38 cm	29 cm	29 cm	black

Trade Pack 5 Pieces



**RADICAL BACK PACK**

Carp anglers the world over spend anything from short overnight sessions to week-long trips at the water. The Back-Packer-System is ideal for solo anglers and can be carried on the back during long walks while offering all the benefits of a modern carp angling bag. Equipped with reinforced front and side walls, a waterproof floor and thick zip fasteners. Material: 100% Nylon

Code	Length	Width	Height
8511 017	50 cm	29 cm	48 cm

kompletný cenník na [www.SPORTS.sk](http://www.SPORTS.sk), výhradný distribútor pre SR: SPORTS s.r.o.





**RADICAL DIP BAG**

We all like a dip! Where would modern carp fishing be without the right selection of bait dips, such as our Bloody Chicken or Yellow Zombie. Our Dip Bag ensures all dips are carried safely. Never again will a dip leak and ruin the contents of a carryall. We have filled the Dip Bag with 6 containers that can accommodate dips, pop-ups or both according to needs. Extremely practical. Material: 100% Nylon

Code	Width	Height	Depth
8511 013	30 cm	20 cm	10 cm



**RADICAL MONKEY BAG**

The Radical Monkey Bag is as strong as an ..... Ape. Small items such as carp tools, wallets, car keys or head torches can all be kept safe and sound. The bag can be attached to any bedchair, chair or rod pod and can also be used as a waist bag, e.g. if mobile or on a boat. Material: 100% Nylon

Code	Width	Height	Depth
8511 010	30 cm	12 cm	12 cm



**RADICAL BOLT BAG**

Bolt rigs are the number one method for targeting specimen carp. But where should you store those heavy weights and backleads? A solution has arrived in the shape of our new heavy-duty Radical Bolt Bags that can be subdivided into two compartments. Material: 100% Nylon

Code	Width	Height	Depth
8511 015	20 cm	15 cm	10 cm



**RADICAL LONG RIG WALLET**

Longer rig wallet than normal, offering more room and better storage of longer rigs. Material: 100% Nylon

Code	Width	Height	Depth
8401 038	33 cm	15 cm	5 cm

Trade Pack 3 Pieces

**RADICAL ROD PROTECTOR SET**

This protective cover offers an extra layer of protection when transporting your rods. Material: Neoprene. Padding: sponge, lining material

Code
8400 037

Trade Pack 3 Pieces



**RADICAL ROD STRAP**

Material: Neoprene

Code	Length	Content
8400 011	21 cm	2 pcs

Trade Pack 10 Pieces







5000 mm water resistance

420 Denier NYLON

**RADICAL BIVVY**

After a long development project, we are proud to offer session anglers a truly remarkable tent, which stands out above the competition with a number of outstanding features: · 140 cm x 240 cm x 180 cm (H/W/D)· 420 Denier Nylon· 100% waterproof and wind-proof material· sealed seams· easy and quick to erect· robust glass-fibre rods· removable groundsheet· transparent window in entry door· front part can be rolled up to the side so that the tent becomes a half-open storm shield (important on waters where enclosed tents are prohibited)· various options for pegging down, standard tent pegs supplied Material: 100% Nylon

Code 9982 001



5000 mm water resistance

**RADICAL SAMBA BROLLY**

Night sessions are not meant to be spent beneath a cramped umbrella. The new Samba Brolly provides enough room to dance and erects in seconds. Our team angler Robin Illner designed the new model with fibreglass spokes, breathable tent fabric, height adjustment, a back-door window, mosquito and rain fronts and many more extras. The Samba Brolly is supplied with storm poles and a groundsheet. Internally, there is sufficient room for a bedchair, a small chair and all the tackle you will need for a night session. Material: 100% Polyurethane

Code	Length	Width	Height	Weight
9982 032	160 cm	280 cm	230 cm	8,54 kg



5000 mm water resistance

420 Denier NYLON

**RADICAL MEGA BROLLY**

When time is of the essence or luggage space is limited, a conventional brolly is not always the best choice. And yet it must be large and robust enough to offer the angler the right protection. The Radical Mega Brolly strikes the perfect balance. Nubrolle system, 3 m diameter, 420D nylon, PU-coated, sealed seams, stainless steel shaft and ground spike, complete with tether and pegs, plus two threaded connections for attaching Storm Poles (not included). Material: 100% Nylon, Polychloride coated

Code 9975 300 3,00 m







5000 mm water resistance



**RADICAL WARCHILD BIVVY**

A tent that extends into a bivvy in seconds. The highly robust material is completely waterproof and windproof. The spacious interior provides space for up to two anglers. The bivvy is equipped with thick zip fasteners, robust tent peg eyelets and strong tent poles. To the front are two windows with mosquito nets and transparent film. The doors can be opened from both sides, with mosquito protection and windows. At the rear of the tent is a large window for optimal ventilation in summer. Supplied with a groundsheet and tent pegs as well as a large bag. Material: 100% Polyurethane

Code	Length	Width	Height	Weight
9982 033	133 cm	270 cm	250 cm	11,14 kg



5000 mm water resistance

**RADICAL TARP**

Flexible pop-up tent or simply a shelter for your tackle. Also ideal protection from strong sunshine and searing heat. Our Tarp can be tied between trees in no time at all or erected with the two poles and lines supplied. Material: 100% Polyurethane

Code	Length	Width	Height	Weight
9982 034	280 cm	280 cm	200 cm	2,00 kg



**RADICAL CARP TRUCK**

Has an ultra-strong metal frame that refuses to buckle even under the heaviest loads. Transports the tackle needed for long sessions effortlessly to the water. Two wheels distribute the heavy load perfectly. The metal frame also accommodates rigid, very versatile, bags (supplied). There is enough room for shoes, clothes and tackle with no wasted space. With its relatively small folded size the truck fits in the boot of even smaller cars.

Code	Length	Width	Height	Weight
8705 006	1,54 m	58 cm	30 cm	9,6 kg





**RADICAL SESSION CHILLER CHAIR 2**

Our Radical Carp Chair "Session Chiller" has special breathable cushioning which moulds to the body shape thanks to its special foam composition. Now you can really enjoy long or "slow" sessions. Armrests add to the comfort. The legs are continuously adjustable to adapt perfectly to every terrain. With special ratchet system for adjusting the backrest and ultra-light aluminium frame. Material: 100% Polyester

Code	Length	Width	Height
9980 022	52 cm	55 cm	92 cm



**RADICAL WARCHILD CHAIR**

Affordable chair - ideal for the carp angler to relax comfortably between bites. In modern Radical design. Material: 100% Polychlorid

Code	Length	Width	Height	Weight
9980 031	62 cm	48 cm	84 cm	4,18 kg



**RADICAL SESSION CHILLER BED CHAIR 2**

Backache from sleeping? No longer with our Carp Couch "Session Chiller" which has special breathable cushioning and moulds to the body shape thanks to its special foam composition. Sweating is reduced significantly, while in winter the cushioning provides extra insulation. The bedchair has 3 pairs of legs for a secure footing. Now you can sleep as if you were on cloud nine. With special ratchet system for adjusting the backrest and ultra-light aluminium frame. Material: 100% Polyester

Code	Length	Width	Height	Weight	Colour
9980 024	2,1 m	82 cm	40 cm	10,3 kg	green



**RADICAL WARCHILD BED CHAIR**

Affordable bedchair - indispensable for overnight sessions. In modern Radical design. Material: 100% Nylon

Code	Length	Width	Height	Weight	Colour
9980 025	198 cm	80 cm	52 cm	8,84 kg	green



**CARP CRADLE**

The huge canyon lakes and big rivers of France are often strewn with sharp stones. This means carp need special protection from the responsible carp angler. The Carp Cradle was developed by Rapahel Biagini, one of France's most renowned carp anglers. The bedchair for carp can be set up in no time, has small packing dimensions and offers the best possible protection for the fish.

Code	Length	Width
8508 001	1,20 m	0,70 m







**BED CHAIR SUPPORT LEG**

This double-leg system can be attached to the foot section of a bedchair in just a few seconds. This way, the foot section acts as both a storage area and seat. The support legs are extremely light yet robust.

Code	Length	Weight
9980 032	32 cm	335 g



**RADICAL WARCHILD BED CHAIR COVER**

The Bedchair Cover guarantees that summer feeling! A light yet warm blanket for the sunnier months in central and southern Europe. You can sleep as though you were on the beach, looking up at the stars. Finished with robust zip fasteners! Fits any bedchair. Material: 100% Polyurethane

Code	Width	Height	Weight
9980 033	148 cm	210 cm	1,74 kg



**INFLATABLE UNHOOKING MAT**

Upholstered, oval unhooking mat with inflatable outer ring to prevent carp from sliding off. Material: 100% Polyurethane

Code	Length	Width	Height
8517 024	110 cm	70 cm	14 cm



**DELUXE UNHOOKING MAT**

This unhooking mat is specially designed for stony and other hard bank surfaces. A thick, gel-type ball filling guarantees the best possible protection for the fish. The filling adapts perfectly to the shape of the fish, without any possibility of a protruding stone. With side panel for the angler to kneel on when removing the hook.

Code	Width	Height
8517 017	80 cm	120 cm

Trade Pack 2 Pieces



**RELAX UNHOOKING MAT**

With our Relax Unhooking Mat, carp feel as though they are lying on cotton wool. The mat comprises a self-inflating floor while the surface material safely protects the carp's delicate mucous membrane. Material: Nylon

Code	Width	Height	Colour
8517 051	70 cm	120 cm	black/orange



**ELDORADO CARPKEEPER**

This sling provides ample space for even large carp while the material offers optimal protection for the mucous membrane. The large foam attachments ensure that the Keepingbag is always held at the surface. The zip fasteners and seams are extremely robust. Equipped with carrying and weighing straps. Material: 100% Polyurethane

Code	Length	Width	Height
8517 020	105 cm	35 cm	35 cm



**CARP SACK**

Many carp sacks are far too small. Fish weighing 40 pounds are no longer a rarity today. And such giant carp can easily measure a metre or more in length! Our new carp sacks safely accommodate even the largest specimens. The material is also extremely fish-friendly and yet robust. Material: 100% Polychlorid

Code	Length	Width
8517 021	130 cm	80 cm





**BAIT BAG**

The Bait Bag is ideal for transporting baits on longer trips. The bag guarantees good air circulation to prevent bait from going mouldy.

Code	Width	Height
8517 035	0,60 m	0,40 m



**BAIT BAG**

Crustaceans, small fish and warm water can soon make boilies disappear from your swim. The solution is to use durable bait. The Team uses the Baitbag to dry out our fast-acting baits where necessary. The Baitbag fits perfectly in the Radical Bait Bucket. Material: 100% Polyester

Code	Length	Width	Height
8517 052	22 cm	30 cm	22 cm

Trade Pack 5 Pieces



**NET SAFE**

Buoyancy aid for landing net handles. Also allows easier handling of larger nets in the water.

Code
8517 018

Trade Pack 5 Pieces



**T-SHIRT RADICAL**

The Radical T-shirts not only look ultra-trendy, they are also made from high-quality, robust material (100% cotton). Clothing with maximum functionality! Material: 100% Cotton. Gram weight: 180 g/m<sup>2</sup>

Code	Size	Colour
8914 002	M	black
8914 003	L	black
8914 004	XL	black
8914 005	XXL	black



**FLEECE JACKET**

Perfect for the changing of the seasons. When it's no longer warm enough to sit at the water in a T-Shirt, but not sufficiently cold to pull out the thermal overalls, this fleece jacket is the perfect choice. Material: 100% Polyester. Gram weight: 215 g/m<sup>2</sup>

Code	Size	Colour
8990 001	M	black
8990 002	L	black
8990 003	XL	black
8990 004	XXL	black



**HOODY RADICAL**

Whether in strong wind, beating sun or driving rain, with the Radical Hoody you are prepared for any weather. The hoody also looks ultra-modern. Smart clothing for modern anglers is the Radical clothing philosophy! Material: 100% Cotton. Gram weight: 280 g/m<sup>2</sup>

Code	Size	Colour
8913 002	M	black
8913 003	L	black
8913 004	XL	black
8913 005	XXL	black



**FLEECE PANTS**

Perfect for the changing of the seasons. Also extremely comfortable - particularly when you quickly need to pull on some over-trousers to react to a bite in the dead of night. Material: 100% Polyester. Gram weight: 215 g/m<sup>2</sup>

Code	Size	Colour
8991 002	L	black
8991 003	XL	black
8991 004	XXL	black



# CAPS & STICKER



## CAP

Material: 100% Cotton. Gram weight: 250 g/m<sup>2</sup>

**Code Colour**  
9788 047 black/orange  
Trade Pack 5 Pieces



## CROCHY CAP

Material: Acrylic. Gram weight: 500 g/m<sup>2</sup>

**Code Colour**  
9788 046 black/orange  
Trade Pack 5 Pieces



## BOWFLAG RADICAL

Includes flag, pole, base plate and bag.

**Code Width Height**  
9966 053 60 cm 260 cm



## STICKER RADICAL CARP

Code	Width	Height
9949 032	9,5 cm	8,0 cm
9949 060	4,5 cm	3,8 cm

Trade Pack 10 Pieces



## STICKER RADICAL

**Code Width Height**  
9949 000 21 cm 14,8 cm  
Trade Pack 10 Pieces



## SEAT SAVER

Dirty car seats after a long trip are a thing of the past. Not only do the new car seat covers from Radical keep your seats clean, they also look cool. Material: 100% Polyester

**Code Content Colour**  
9906 002 1 pcs black



# FIN-NOR<sup>®</sup>

High-tech products of uncompromising quality with a long tradition for use in extreme situations. With its roots in big game angling, today's product line boasts optimal products for a range of other forms of sea angling, which will also prove popular with freshwater big specimen hunters.





# LEVER DRAG 2 SPEED



### STANDARD TECHNICAL EQUIPMENT:

- Housing produced in aluminium to be completely distortion-free
- Finely adjustable lever drag with carbon drag discs
- Stainless steel handle
- Gears made from a super-hard stainless steel alloy
- Second power speed with 3.1 : 1 gear ratio
- Continuous anti-reverse



## MARQUESA 2 SPEED

The Fin-Nor "Marquesa-2-Speed" multiplier was crowned best new multiplier reel at the EFTTEX European fishing tackle trade fair in Amsterdam in June 2011, where it was also presented to the public for the first time. The reel, which is CNC-machined from an aluminium block, impresses with its high gear ratio but can also be used in its low-gear-ratio second speed for heavy duty requirements. Such requirements are also supported by the CNC-machined, over-sized gears and the drag with carbon discs as found in really large big-game multipliers. Overall, the reel can create up to 50 pounds of drag pressure. At just over 800-950 grams in weight, the Marquesa-2-Speed is best suited to stand-up fishing and can be used for various other sea angling techniques. Packaging this technical marvel in eye-catching silver and gold is sure to assist its popularity.

Code	Model	m / mm	Gear Ratio	Retrieve	BB	Drag F.	Weight
0619 020	MA20II	275 / 0,35	6.1:1 / 3.1:1	135 cm	7	11,3 kg / 25 lbs	814 g
0619 030	MA30II	295 / 0,40	6.1:1 / 3.1:1	135 cm	7	11,3 kg / 25 lbs	828 g
0619 040	MA40II	400 / 0,40	5.2:1 / 2.8:1	130 cm	7	13,6 kg / 30 lbs	947 g
0619 050	MA50II	425 / 0,50	5.2:1 / 2.8:1	130 cm	7	13,6 kg / 30 lbs	970 g



### STANDARD TECHNICAL EQUIPMENT:

- Housing produced in aluminium to be completely distortion-free
- Ergonomically designed handle knob for optimal power transfer
- Dial-adjustable clicker tension



## MARQUESA

The ultimate offering of precision, strength and refinement: Marquesa is ideal for fishing the new, thinner braided superlines in a platform design that is lighter, faster, and stronger than anything you've ever seen on the water. Marquesa is precision-machined from 6061-T6 aluminum, and features one of the strongest drag systems ever put into a reel — stronger, in fact, than many "international-type" reels that are much bigger and heavier. Marquesas are the perfect reels for tournament fishing or stand-up fishing with newer, stronger lines and fishing techniques. Marquesa is big fish stopping power in a very refined package.

Code	Model	m / mm	Gear Ratio	Retrieve	BB	Drag F.	Weight
0622 012	MA12	245 / 0,26	6.1:1	109 cm	7	6,8 kg / 15 lbs	567 g
0622 016	MA16	265 / 0,30	6.1:1	109 cm	7	6,8 kg / 15 lbs	595 g
0622 020	MA20	275 / 0,35	6.1:1	130 cm	7	8,2 kg / 18 lbs	760 g
0622 030	MA30	295 / 0,40	6.1:1	130 cm	7	8,2 kg / 18 lbs	777 g

Spare Spool	Model	Material
0984 030	Sp.Spool FN MA12	Alu
0984 031	Sp.Spool FN MA16	Alu
0984 032	Sp.Spool FN MA20/20T	Alu
0984 033	Sp.Spool FN MA30/30T	Alu



# LEVER DRAG



**STANDARD TECHNICAL EQUIPMENT:**

- Fully machined one-piece aluminium housing
- Finely adjustable lever drag with carbon drag discs
- CNC stainless steel handle
- Super-hard brass transmission components
- Continuous anti-reverse



## FIN-NOR MARQUESA

For anglers pursuing sailfish and marlin on lighter standup tackle, our new Marquesa Pelagic series is the perfect choice. The custom drag cam is designed to provide a more linear drag range from 0 - 15 lbs., allowing fine adjustments in the lower drag range. The top crossbar helps manage spool overrun for kite fishing and live baiting techniques, and the high-speed retrieve makes this the ultimate reel for billfish enthusiasts. The 2-stage cam system in our new Marquesa Pelagic reels gives you more control in settings below the "Strike" position, and a steeper control curve when more-than-strike is needed.

Code	Model	m / mm	Gear Ratio	Retrieve	BB	Drag F.	Weight
0617 030	MA30TP	410 / 0,33	6,1:1	130 cm	6	5,5 kg / 12 lbs	776 g
0617 040	MA40TP	400 / 0,40	5,2:1	127 cm	6	7,0 kg / 15 lbs	898 g

Spare Spool	Model
0984 096	Sp.Spool Fin-Nor Marquesa MA30TP
0984 097	Sp.Spool Fin-Nor Marquesa MA40TP



**STANDARD TECHNICAL EQUIPMENT:**

- Aluminium body and sidecovers
- Finely adjustable lever drag with carbon drag discs
- Extra large, secure grip handle knob
- Super-hard brass transmission components
- Rapid line retrieval
- Continuous anti-reverse
- Saltguard multi-layer housing coating



## PRIMAL

The design of the Fin-Nor Primal disc-drag reels continues a family tradition in saltwater multipliers. The Primal series includes two new very small sizes, which primarily cater for fishing with very thin yet strong braided lines. This means the reel is no longer like a heavy brick on the rod and the angler can enjoy limitless pleasure on the water. The power of these mini-marvels is simply incredible. The Primal also impresses with extraordinary line retrieval.

Code	Model	m / mm	Gear Ratio	Retrieve	BB	Drag F.	Weight
0625 010	PR10HS	345 / 0,25	7,2:1	102 cm	7	15 kg / 33 lbs	380 g
0625 012	PR12HS	450 / 0,27	7,2:1	102 cm	7	15 kg / 33 lbs	392 g

Spare Spool	Model	Material
0984 210	Sp.Spool PR10HS	Alu
0984 212	Sp.Spool PR12HS	Alu

kompletný cenník na [www.SPORTS.sk](http://www.SPORTS.sk), výhradný distribútor pre SR: SPORTS s.r.o.



# LEVER DRAG 2 SPEED



**NEW**



- STANDARD TECHNICAL EQUIPMENT:**
- Fully machined one-piece aluminium housing
  - MegaDrag™ stainless steel and carbon fibre drag system
  - Extra large, secure grip handle knob
  - Robust, machine made gears
  - Second power speed with 3.1 : 1 gear ratio
  - Continuous anti-reverse
  - Saltguard multi-layer housing coating



## LETHAL LT 2 SPEED

The design of the Fin-Nor Lethal disc-drag reels continues the family tradition but with a smaller baitcaster reel design. The strength of the reel is beyond doubt. No comparable reel has a main gearwheel, an anti-reverse system and a ball bearing of such dimensions. The two-speed gears also leave nothing to be desired, whether quickly retrieving the bait for inspection or emphatically defeating a powerful opponent in the lower gear.

Code	Model	m / mm	Gear Ratio	Retrieve	BB	Drag F.	Weight
0612 016	LTL16II	320 / 0,46	6,3:1 / 3,0:1	124 / 60 cm	6	16 kg / 35 lbs	688 g
0612 020	LTL20II	350 / 0,58	6,3:1 / 3,0:1	124 / 60 cm	6	16 kg / 35 lbs	706 g
0612 030	LTL30II	330 / 0,65	6,3:1 / 3,0:1	124 / 60 cm	6	16 kg / 35 lbs	721 g

Spare Spool	Model
0984 101	Sp.Spool Lethal LT 2 Speed LTL16II
0984 102	Sp.Spool Lethal LT 2 Speed LTL20II
0984 103	Sp.Spool Lethal LT 2 Speed LTL30II



- STANDARD TECHNICAL EQUIPMENT:**
- Fully machined one-piece aluminium housing
  - MegaDrag™ stainless steel and carbon fibre drag system
  - Stainless steel handle
  - Oversized stainless steel main gear with brass pinion gear
  - Continuous anti-reverse
  - Highly audible clicker
  - MegaShield™ multi-layer coating



## LETHAL LTC H

The Fin-Nor Lethal reels are built to carry on the family tradition, but do so in a smaller, faster, lighter and stronger casting reel design. There's no doubt about strength because no other reels have as large of a main gear, anti-reverse or ball bearings.

Code	Model	m / mm	Gear Ratio	Retrieve	BB	Drag F.	Weight
0605 016	16	320 / 0,46	6,2:1	124 cm	7	11,3 kg / 25 lbs	666 g
0605 020	20	350 / 0,58	6,2:1	124 cm	7	11,3 kg / 25 lbs	686 g
0605 030	30	330 / 0,65	6,2:1	124 cm	7	11,3 kg / 25 lbs	708 g



Spare Spool	Model	Material
0984 086	Sp.Spool FN Lethal H LTC16	Alu
0984 087	Sp.Spool FN Lethal H LTC20	Alu
0984 088	Sp.Spool FN Lethal H LTC30	Alu

kompletný cenník na [www.SPORTS.sk](http://www.SPORTS.sk), výhradný distribútor pre SR: SPORTS s.r.o.



# LEVER DRAG



## SPORTFISHER TROLLING LD

A functionally attractive Fin-Nor multiplier with a highly robust drag disc system and Level Wind. In use, this rock solid model is practically foolproof. Available in the two most common sizes for trolling and lighter forms of natural bait fishing. With high-performance gears and carbon drag discs that allow the drag system to bring its full strength to bear. Trolling anglers will quickly appreciate the easily audible clicker which acts as a bite indicator.

Code	Model	m / mm	Gear Ratio	Retrieve	BB	Drag F.	Weight
0335 020	520 LW	320 / 0,45	4.2:1	42 cm	5	10,9 kg / 24 lbs	568 g
0335 030	530 LW	460 / 0,50	4.2:1	52 cm	5	13,6 kg / 30 lbs	676 g



### STANDARD TECHNICAL EQUIPMENT:

- Robust gear housing made from stainless steel reinforced fibre plastic
- Finely adjustable lever drag with carbon drag discs
- CNC stainless steel handle
- Super-hard, oversized brass gear components

Spare Spool	Model	Material
0987 117	Sp.Spool FN Sportf. Trolling LD520	Alu
0987 118	Sp.Spool FN Sportf. Trolling LD530	Alu



## SPORTFISHER TROLLING SD

The "People's Multiplier" – a reel for all purposes. Popular star-wheel drag multiplier as used by countless thousands of anglers every day on the world's oceans. Whether trolling or using natural baits, this easy-to-handle and indestructible Fin-Nor multiplier is expected to become a best seller.

Code	Model	m / mm	Gear Ratio	Retrieve	BB	Drag F.	Weight
0328 020	220 LW	450 / 0,40	4.2:1	61 cm	2	10,9 kg / 24 lbs	525 g
0328 030	230 LW	425 / 0,50	4.4:1	83 cm	2	13,6 kg / 30 lbs	693 g



### STANDARD TECHNICAL EQUIPMENT:

- Robust gear housing made from stainless steel reinforced fibre plastic
- Oversized multi-stack Offshore drag system
- Extra large, secure grip handle knob
- Powerful gears
- Aluminium spool

Spare Spool	Model	Material
0987 158	Sp.Spool FN Sportf. Trolling SD220	Alu
0987 159	Sp.Spool Sportf. Trolling SD230	Alu



# STAR DRAG



## SPORTFISHER TROLLING SLC

Popular trolling multiplier with line counter as used by countless anglers every day on the world's oceans. This easy-to-handle and indestructible Fin-Nor multiplier is sure to impress all anglers who always have to keep the amount of line deployed in mind, e.g. when trolling with side planers.



Code	Model	m / mm	Gear Ratio	Retrieve	BB	Drag F.	Weight
0606 030	30	205 / 0,58	4.2:1	65 cm	2	13,6 kg / 30 lbs	558 g

### STANDARD TECHNICAL EQUIPMENT:

- Robust gear housing made from stainless steel reinforced fibre plastic
- MegaDrag™ stainless steel and carbon fibre drag system
- CNC stainless steel handle
- Super-hard brass transmission components
- Multistop anti-reverse clutch
- Highly audible clicker

Spare Spool	Model	Material
0984 085	Sp.Spool FN Sportfisher SLC30	Alu



A top seller with an improved design!

Now also available in size #105! Line capacity: 700m/0.45mm!

## OFFSHORE SPINNING

When it comes to landing truly giant fish, delicate reels are not the order of the day. Lightweight reels and smooth gear actions are just not on the shopping list. What the angler needs is a reel that will never let him down. The Fin-Nor Offshore is the fighting machine that ticks all the boxes. This is no fashion accessory, it is a no-frills powerhouse. In contrast with the size #95 version, the new model (size #105) with its simply incredible line capacity has a manual bail arm.



Code	Model	m / mm	Gear Ratio	Retrieve	BB	Drag F.	Weight
0613 065	OFS6500	360 / 0,45	4,4:1	87 cm	4	13,6 kg / 30 lbs	882 g
0613 075	OFS7500	420 / 0,45	4,4:1	93 cm	4	18,1 kg / 40 lbs	905 g
0613 085	OFS8500	490 / 0,45	4,4:1	102 cm	4	27,2 kg / 60 lbs	1070 g
0613 095	OFS9500	540 / 0,45	4,4:1	108 cm	4	27,2 kg / 60 lbs	1101 g
0613 105	OFS10500	700 / 0,45	4,4:1	115 cm	4	27,2 kg / 60 lbs	1135 g

### STANDARD TECHNICAL EQUIPMENT:

- Aluminium body and sidecovers
- Oversized multi-stack Offshore drag system
- CNC stainless steel handle
- Large line roller with anti-twist system
- Robust bronze and stainless steel gears
- Aluminium spool
- S-curve line distribution
- Multistop anti-reverse clutch
- External catch prevents bail arm from closing on the cast

Spare Spool	Model	Material
0984 106	Sp.Spool FN OFS6500	Alu
0984 107	Sp.Spool FN OFS7500	Alu
0984 108	Sp.Spool FN OFS8500	Alu
0984 109	Sp.Spool FN OFS9500	Alu
0984 105	Sp.Spool FN OFS10500	Alu

kompletný cenník na [www.SPORTS.sk](http://www.SPORTS.sk), výhradný distribútor pre SR: SPORTS s.r.o.



# FRONT DRAG SPINNING



## LETHAL SPINNING

The Fin-Nor Lethal has earned its rightful place in the Fin-Nor range of fixed-spool reels. Available in four sizes, this workhorse covers a range of applications in sea angling. The reel contains no delicate components, and comes with an anti-reverse that cannot be disengaged. Excellently suited to catfish, predator and sea angling.



Code	Model	m / mm	Gear Ratio	Retrieve	BB	Drag F.	Weight
0624 040	LT40	210 / 0,30	5.2:1	78 cm	7	10,4 kg / 23 lbs	382 g
0624 060	LT60	220 / 0,40	4.9:1	83 cm	7	13,6 kg / 30 lbs	617 g
0624 080	LT80	270 / 0,45	4.9:1	94 cm	7	18,1 kg / 40 lbs	697 g
0624 100	LT100	265 / 0,50	4.9:1	103 cm	7	20,4 kg / 45 lbs	870 g

### STANDARD TECHNICAL EQUIPMENT:

- Ultra-strong aluminium housing, sideplates and rotor
- Finely adjustable, protected Magnum CSC™ front drag system (carbon drag discs)
- Oversized handle knob for optimal power
- Continuous anti-reverse
- MegaShield™ multi-layer coating

Spare Spool	Model	Material
0984 074	Sp.Spool FN Lethal LT40	Alu
0984 076	Sp.Spool FN Lethal LT60	Alu
0984 078	Sp.Spool FN Lethal LT80	Alu
0984 079	Sp.Spool FN Lethal LT100	Alu



## TIDAL

Indestructible reels have always been one of Fin-Nor's hallmarks. The new Fin-Nor Tidal continues this tradition seamlessly. Besides the twist-free aluminium housing and many existing stainless steel components, the gears have now been optimised for power transfer. This makes the Tidal the ultimate fighting machine for catfish, pike and deep-sea anglers, and at a highly attractive price!



Code	Model	m / mm	Gear Ratio	Retrieve	BB	Drag F.	Weight
0607 045	T 545	210 / 0,31	5.2:1	81 cm	5	11,3 kg / 25 lbs	348 g
0607 055	T 555	120 / 0,41	4.9:1	85 cm	5	13,6 kg / 30 lbs	550 g
0607 065	T 565	150 / 0,40	4.9:1	91 cm	5	18,1 kg / 40 lbs	556 g
0607 075	T 575	280 / 0,40	4.9:1	104 cm	5	20,4 kg / 45 lbs	715 g
0607 095	T 595	400 / 0,45	4.9:1	120 cm	5	20,4 kg / 45 lbs	745 g

### STANDARD TECHNICAL EQUIPMENT:

- Rotor produced in aluminium to be completely distortion-free
- Housing produced in aluminium to be completely distortion-free
- Front drag with Magnum carbon drag discs
- CNC stainless steel handle
- Titanium-nitride-coated line roller
- Thick bail arm for optimal balance
- Extra-strong stainless steel main shaft
- Aluminium Long Stroke™ spool
- Two-speed oscillation system
- Continuous anti-reverse

Spare Spool	Model
0984 091	Sp. Spool Tidal T 545
0984 092	Sp. Spool Tidal T 555
0984 093	Sp. Spool Tidal T 565
0984 094	Sp. Spool Tidal T 575
0984 095	Sp. Spool Tidal T 595

kompletný cenník na [www.SPORTS.sk](http://www.SPORTS.sk), výhradný distribútor pre SR: SPORTS s.r.o.



# FRONT DRAG SPINNING



## FIN-NOR MEGALITE

Robust yet relatively inexpensive sea reel series for a wide range of applications. Fin-Nor quality made affordable. Simply perfect for the sea angling fan. Packaged in an attractive contemporary design.



### STANDARD TECHNICAL EQUIPMENT:

- CarbonGraphite rotor
- Compact housing design
- Oversized multi-stack drag system
- Die-cast aluminium handle
- Large line guide
- Powerful gears
- Aluminium spool
- S-curve line distribution
- Continuous anti-reverse

Code	Model	m / mm	Gear Ratio	Retrieve	BB	Drag F.	Weight
0346 040	40	230 / 0,22	5,2:1	76 cm	5	6,5 kg / 14 lbs	320 g
0346 060	60	300 / 0,26	4,9:1	83 cm	5	12,0 kg / 26 lbs	550 g
0346 080	80	400 / 0,30	4,9:1	94 cm	5	15,0 kg / 33 lbs	690 g
0346 100	100	274 / 0,45	4,9:1	100 cm	5	15,0 kg / 33 lbs	700 g

Spare Spool	Model
0986 003	Sp.Spool Megalite 40
0986 004	Sp.Spool Megalite 60
0986 005	Sp.Spool Megalite 80
0986 006	Sp.Spool Megalite 100



### STANDARD TECHNICAL EQUIPMENT:

- Metal body
- Front drag with Magnum carbon drag discs
- Oversized handle knob for optimal power
- Super-hard brass transmission components
- Aluminium spare spool
- Continuous anti-reverse



## RAINER KORN SPORTFISHER FD

I spent a long time looking for an affordable yet ultra-robust fixed-spool reel for intermediate sea angling. In the Rainer Korn Sportfisher, Fin-Nor has introduced just such a reel into its range. Without unnecessary high-tech frills that mostly fail when it comes down to it! A genuine sea reel with ultra-smooth carbon front drag – particularly important for rapid predators such as halibut, coalfish or sailfish. With robust yet light metal spool and CNC-formed metal handle with ergonomic knob for those hard fights. We have omitted the superfluous and fault-prone switch for turning off the anti-reverse from this reel. Who actually backwinds? The Rainer Korn Sportfisher is available in the two most frequently used sizes: as a 640 and 650 model (250 m/0.28 mm and 235 m/0.30 mm). All reels are supplied with a spare spool. The workhorse is equipped with 6 strong ball bearings. The gear ratios (5.2:1 and 4.9:1) have been selected to enable rapid lure retrieval while allowing the full power of the reels to be exerted on the fish during a fight. I am truly proud of this first Rainer Korn fixed-spool reel! I hope it also lands you some outstanding fish.

Code	Model	m / mm	Gear Ratio	Retrieve	BB	Drag F.	Weight
0294 040	640	250 / 0,28	5,2:1	86 cm	6	10,4 kg / 23 lbs	371 g
0294 050	650	235 / 0,30	4,9:1	75 cm	6	13,6 kg / 30 lbs	560 g

Spare Spool	Model	Material
0984 080	Sp.Spool FN RK Sportfisher FD640	Alu
0984 081	Sp.Spool FN RK Sportfisher FD650	Alu



kompletný cenník na [www.SPORTS.sk](http://www.SPORTS.sk), výhradný distribútor pre SR: SPORTS s.r.o.



SPINNING



Code	Model	Length	Sections	C.W.	Tr.-Length	Weight
13080 230	Lethal Lure L	2,30 m	2	40 - 140 g	1,20 m	289 g
13080 270	Lethal Lure L	2,70 m	2	40 - 140 g	1,42 m	332 g

LETHAL LURE L

Lethal - the sensational rod series with a full-carbon blank tip section. Unlike hollow rods, this design is practically indestructible and yet extremely slim. This slender design ensures a very low rod weight despite the solid material. The Model Lure is designed for modern lure fishing at sea.



Code	Model	Length	Sections	C.W.	Tr.-Length	Weight
13084 220	Lethal Sea Spin	2,20 m	2	30 - 70 g	1,65 m	266 g
13084 221	Lethal Sea Spin H	2,20 m	2	50 - 300 g	1,15 m	281 g
13084 240	Lethal Sea Spin	2,40 m	2	30 - 70 g	1,70 m	298 g
13084 270	Lethal Sea Spin	2,70 m	2	30 - 70 g	1,40 m	312 g

LETHAL SEA SPIN

Lethal - the sensational rod series with a full-carbon blank. Unlike hollow rods, this design is practically indestructible and yet extremely slim. This slender design ensures a very low rod weight despite the solid material. The Model Sea Spin is designed for modern spinning at sea.



Code	Model	Length	Sections	C.W.	Tr.-Length	Weight
13083 210	Lethal Variado	2,10 m	2	6 - 12 lbs	1,52 m	292 g
13083 211	Lethal Variado	2,10 m	2	12 - 20 lbs	1,52 m	314 g
13083 212	Lethal Variado	2,10 m	2	20 - 30 lbs	1,52 m	349 g

LETHAL VARIADO

Lethal - the sensational rod series with a full-carbon blank. Unlike hollow rods, this design is practically indestructible and yet extremely slim. This slender design ensures a very low rod weight despite the solid material. The Model Variado is designed for light trolling and a variety of other boat fishing applications.



**INDESTRUCTIBLE.  
REINVENTED.**

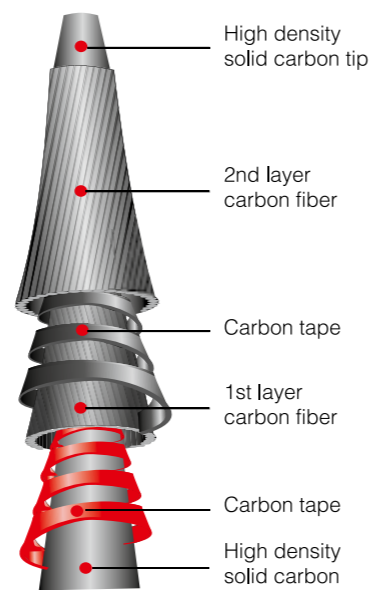

**SOLID CARBON TECHNOLOGY**

EXTREMELY SLIM  
INCREDIBLE STRONG  
ULTRA SENSITIVE



kompletný cenník na [www.SPORTS.sk](http://www.SPORTS.sk), výhradný distribútor pre SR: SPORTS s.r.o.



BOAT



Code	Model	Length	Sections	C.W.	Tr.-Length	Weight
13025 220	Valhall 2.0 II	2,20 m	2	40 - 140 g / vertical - 220 g	1,70 m	263 g



VALHALL 2.0 II

The wise men say that better is the enemy of good! Fin-Nor and I have heeded this saying in the new Valhall. The powerful sea spinning rod combines all of the benefits a rod like this should offer: light weight, slender blank and plenty of power. The completely redeveloped full-carbon blank is equipped with the finest components: Fuji K-frame rings with extra underwhipping; slender, high-grip Fuji reel holder; robust end cap with cross for rod holders and gimbal – also from Fuji. The EVA handle is ergonomically designed to enable fishing over several hours or gruelling fights to be managed with ease. The asymmetric rod sections were a particularly important feature for me. The entire ringed section is in one piece, which significantly increases stability. Visually, the Valhall has turned out to be a true delight. With a casting weight of 40 to 140 grams and a length of 2.20 m, the rod is perfect for heavy sea spinning whether in Norway, Iceland or in tropical waters. Baits of up to 220 grams can be fished vertically with ease.



Code	Model	Length	Sections	C.W.	Tr.-Length	Weight
13027 220	Valhall Light	2,20 m	2	30 - 80 g / vertical - 150 g	1,68 m	248 g



VALHALL LIGHT

Now, at last, there is also a lighter version of the Valhall, which will particularly appeal to light sea spinning fans. The first time I tested the prototype, this sensitive yet powerful rod captured my heart. Simply a dream rod! The same design and components as its "big" sister. Casting weight of 30 to 80 grams; baits of up to 150 grams can be fished with ease.



Code	Model	Length	Sections	C.W.	Tr.-Length	Weight
13026 220	Valhall 2.0 II Traveller	2,20 m	4	40 - 140 g / vertical - 220 g	0,61 m	252 g



VALHALL 2.0 II TRAVELLER

And of course, there is a version of the new Valhall for your travels. With four sections and a transport length of just 61 cm, this version is ideal when travelling by plane, roadster or motorbike. Uses the same components as the two-section Valhall. Long male joints ensure stable connections of the rod sections and give the Valhall Traveller its power. Casting weight: 40 to 140 g, vertical up to 220 g. Valhall Light: Casting weight: 30 to 80 g, vertical up to 150 g. Length of both models: 2.2 m

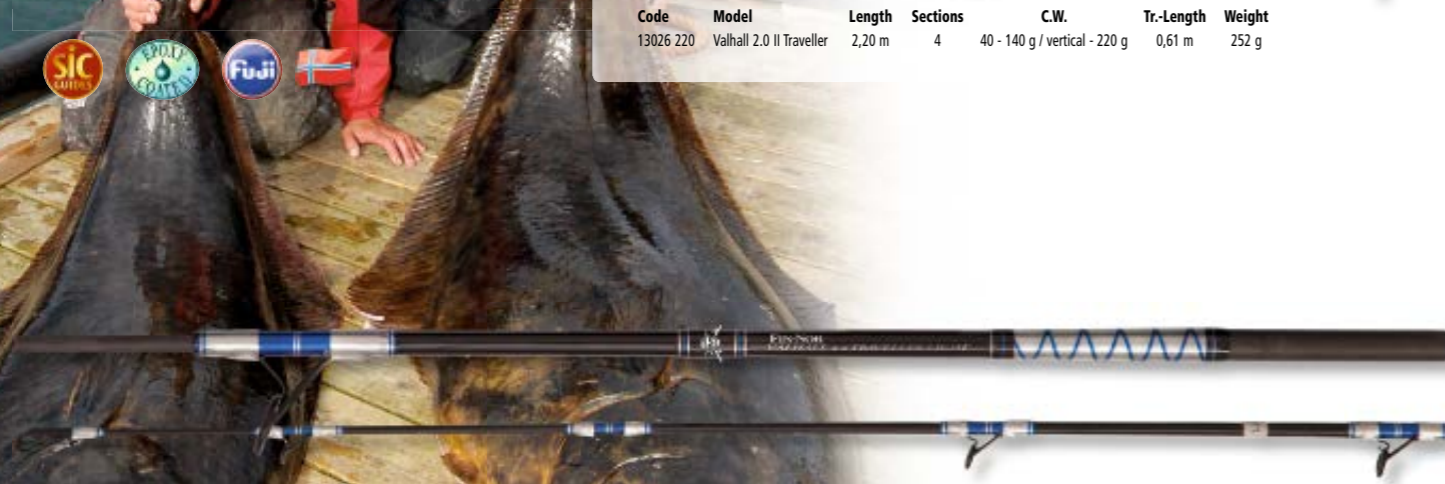

Code	Model	Length	Sections	C.W.	Tr.-Length	Weight
13028 220	Valhall 2.0 Traveller Light	2,20 m	4	30 - 80 g / Vertical: 150 - g	0,61 m	230 g



VALHALL 2.0 TRAVELLER LIGHT

And of course, there is a version of the new Valhall for your travels. With four sections and a transport length of just 61 cm, this version is ideal when travelling by plane, roadster or motorbike. Uses the same components as the two-section Valhall. Long male joints ensure stable connections of the rod sections and give the Valhall Traveller its power. Casting weight: 40 to 140 g, vertical up to 220 g. Valhall Light: Casting weight: 30 to 80 g, vertical up to 150 g. Length of both models: 2.2 m



kompletný cenník na [www.SPORTS.sk](http://www.SPORTS.sk), výhradný distribútor pre SR: SPORTS s.r.o.



# BOAT



Code	Model	Length	Sections	C.W.	Tr.-Length	Weight
13004 240	Tidal Seacaster	2,40 m	2	100 - 180 g	1,26 m	303 g
13004 285	Tidal Seacaster	2,85 m	2	100 - 180 g	1,49 m	352 g

## TIDAL SEACASTER

Whether from a small boat or cutter – piking and jigging are widespread. And with this rod series, you have nothing to fear from the large cod, coalfish or pollock. On the contrary, these rods have sufficient power to reliably bring monster specimens to the surface.



Code	Model	Length	Sections	C.W.	Tr.-Length	Weight
13003 240	Tidal Baycaster	2,40 m	2	60 - 140 g	1,25 m	272 g
13003 285	Tidal Baycaster	2,85 m	2	60 - 140 g	1,47 m	308 g

## TIDAL BAYCASTER

Light sea rod with a medium casting weight. Suitable for flatfish, cod and other species. The robust blanks can also tolerate the occasional impacts that go with the territory during boat fishing.



Code	Model	Length	Sections	C.W.	Tr.-Length	Weight
13002 210	Tidal Deep Seacaster	2,10 m	2	80 - 300 g	1,12 m	411 g
13002 240	Tidal Deep Seacaster	2,40 m	2	80 - 300 g	1,25 m	462 g

## TIDAL DEEP SEACASTER

Equipped for big fish such as catfish, large cod and similar, the Hard Work offers all the advantages of a big fish rod. The uncompromising power, durability and naturally light weight of these rods provide all the ingredients to come out on top against large specimens. And the material itself will tame even the biggest monsters!



Code	Model	Length	Sections	C.W.	Tr.-Length	Weight
13005 210	Tidal Deep Sea Lifter	2,10 m	2	600 g	1,11 m	464 g
13005 240	Tidal Deep Sea Lifter	2,40 m	2	600 g	1,26 m	536 g

## TIDAL DEEP SEA LIFTER

The rod for extreme deep-sea fishing, e.g. in Norway, where heavy weights are used and a normal boat rod is no longer up to the job. Combine an unbeatable carbon blank with the finest features and the result is an absolute gem for deep-sea fans.



kompletný cenník na [www.SPORTS.sk](http://www.SPORTS.sk), výhradný distribútor pre SR: SPORTS s.r.o.



# BOAT



Code	Model	Length	Sections	C.W.	Tr.-Length	Weight
13006 240	Tidal Traveller	2,40 m	4	400 g	0,65 m	389 g
13006 270	Tidal Traveller	2,70 m	5	180 g	0,60 m	327 g



## TIDAL TRAVELLER

Perfect travel rod for the globetrotting sea angler. This 2.4m, four-piece powerhouse will tame even heavy opponents with ease.



Code	Model	Length	Sections	C.W.	Tr.-Length	Weight
13000 240	Tidal Braid Jigger	2,40 m	1+1	12 - 20 lbs	1,77 m	511 g
13000 241	Tidal Braid Jigger	2,40 m	1+1	20 - 30 lbs	1,77 m	527 g

## TIDAL BRAID JIGGER

Special rods for vertical jigging. Super-light blank with a somewhat longer design than customary speed-jigging rods. Suitable for universal use in a variety of marine regions. The through action is best suited to the use of low-stretch braided lines and prevents pull-outs with saltwater predators.



Code	Model	Length	Sections	C.W.	Tr.-Length	Weight
13001 170	Tidal Vertical Jigger	1,70 m	1+1	60 - 120 g	1,07 m	336 g
13001 171	Tidal Vertical Jigger	1,70 m	1+1	150 - 300 g	1,07 m	338 g

## TIDAL VERTICAL JIGGER

For speed-jigging! Ultra-light, short rods that punch above their weight. Originally only used in warmer climates such as the Mediterranean for tuna and similar, also perfectly suited to Nordic regions.



Code	Model	Length	Sections	C.W.	Tr.-Length	Weight
13007 170	Tidal Stand Up	1,70 m	1	12 lbs	1,70 m	376 g
13007 171	Tidal Stand Up	1,70 m	1	20 lbs	1,70 m	388 g
13007 172	Tidal Stand Up	1,70 m	1	30 lbs	1,70 m	401 g

## TIDAL STAND UP

For light deep sea fishing, e.g. in the Mediterranean, we have developed this range of short stand-up rods. Strong enough to tame even the most ferocious quarry without a fighting chair. Their quality lies not only in their perfect fighting action, but in first class finishing and robust rod rings.

kompletný cenník na [www.SPORTS.sk](http://www.SPORTS.sk), výhradný distribútor pre SR: SPORTS s.r.o.



# CAPS



## FIN-NOR CAPS

Material: 100% Cotton

**Code**    **Colour**  
9788 044    gold

Trade Pack 5 Pieces



## FIN-NOR STICKER

**Code**    **Width**    **Height**  
9971 963    42 cm    10 cm



## MEASURE TAPE STICKER

Special high-tech boat sticker with certified seawater resistance. Highly UV-resistant thanks to the use of screen printing. The UV resistance lasts several years depending on use and the intensity of the actual radiation. Material: Poly-chlorid adhesive film, P4 polyacrylate high-tech adhesive with certified seawater resistance

**Code**    **Width**    **Height**  
9949 038    119 cm    12,4 cm

Trade Pack 5 Pieces



kompletný cenník na [www.SPORTS.sk](http://www.SPORTS.sk), výhradný distribútor pre SR: SPORTS s.r.o.





# RHINO

Rhino is definitely the brand for serious anglers. Particularly those who look for that extra performance in their products and an assurance of constant quality from their tackle. Extreme performance for a fair price.





**REELS**

Rhino Trolling R3

**RODS**

Boat R4-7

**ACCESSORIES**

Wire Traces	R8-10
Spoon	R11-22
Bait Holder	R23
Soft Lures, Salmon Tracker, Box	R23-24
Special Leads	R24-25
Boat Rod Holder	R26-27
VX Motor & Spare Parts	R28-29
BLX Motor & Spare Parts	R30-31
Cobold Motor & Spare Parts	R32-33
Landing Net, Promotional Items	R34

**RHINO TROLLING**

The ideal multiplier reel with line counter for our trolling rods. The counter measures the length of line let out in feet (1 foot = 30.5 cm) enabling trolling and sea anglers to control their bait depth even more accurately. Four ball bearings ensure a smooth action while a power handle provides the necessary drive. The jerk-free drag has sufficient bite to stop ferocious opponents. The reel is available in right-hand and left-hand versions covering a range of angling conditions from salmon and pike trolling to intermediate sea angling.

**STANDARD TECHNICAL EQUIPMENT:**

- Robust nylon housing
- Oversized multi-stack drag system
- Powerful gears
- Continuous anti-reverse



Code	Model	m / mm	Gear Ratio	Retrieve	BB	Drag F.	Weight
0609 030	430 RH	320 / 0,45	4,1:1	68 cm	4	15 kg / 33 lbs	614 g
0609 130	430 LH	320 / 0,45	4,1:1	68 cm	4	15 kg / 33 lbs	614 g

Spare Spool	Model
0984 027	Sp.Spool Rhino Trolling 430 RH
0984 028	Sp.Spool Rhino Trolling 430 LH

 kompletný cenník na [www.SPORTS.sk](http://www.SPORTS.sk), výhradný distribútor pre SR: SPORTS s.r.o.





**BALTIC TROLLING RIGGER**

Shorter downrigger rods take up less space, meaning easier storage and more room on the boat when a fight is on. Mike Luner (two-time European Trolling Championship runner-up) developed the range, with a central focus on providing sufficient power – even for big salmon – balanced with enough softness to ensure the right amount of action.

Code	Model	Length	Sections	C.W.	Tr.-Length	Weight
1457 210	Baltic Trolling Rigger	2,10 m	2	10 - 20 lbs	1,13 m	340 g
1457 240	Baltic Trolling Rigger	2,40 m	2	10 - 20 lbs	1,28 m	380 g

**BALTIC TROLLING PLANER BOARD**

Powerful yet sensitive rod for planer board angling. Whether you are fishing with inline boards or larger planer boards, this rod offers the necessary length to hold the line above the water and can take large paravanes or small diving discs without compromising its positive fight qualities.

Code	Model	Length	Sections	C.W.	Tr.-Length	Weight
1458 260	Baltic Trolling Planer Board	2,60 m	2	10 - 20 lbs	1,35 m	418 g

**TROLLING MASTER RIGGER**

Ultra-modern new trolling rod with a very light and slender blank. The fully parabolic action forgives any mistakes during a fight and makes battling with sprightly salmonids a pure pleasure. Also outstandingly suited to sea trout fishing as well as for targeting salmonids in the Baltic Sea that do need quite so much backbone e.g. trolling for cod.

Code	Model	Length	Sections	C.W.	Tr.-Length	Weight
13018 210	Trolling Master Rigger	2,10 m	2	8 - 20 lbs / 30 - 80 g	1,13 m	259 g
13018 240	Trolling Master Rigger	2,40 m	2	8 - 20 lbs / 30 - 80 g	1,24 m	282 g





## BALTIC TROLLING INLINE

An innovation for inline fans. These rods make line tangling around the rings a thing of the past. The rods' hallmark is their sensitive through action that leaves nothing to be desired when it comes to power. Also a good choice for light piking. Threader included.

Code	Model	Length	Sections	C.W.	Tr.-Length	Weight
1456 210	Baltic Trolling Inline	2,10 m	2	10 - 20 lbs	1,13 m	280 g
1456 211	Baltic Trolling Inline	2,10 m	2	8 - 16 lbs / 30 - 70 g	1,13 m	270 g
1456 240	Baltic Trolling Inline	2,40 m	2	15 - 25 lbs	1,24 m	305 g
1456 270	Baltic Trolling Inline	2,70 m	2	20 - 30 lbs	1,41 m	294 g

## TROLLING TEAM RIGGER WITCH

This special downrigger rod makes trolling a magical experience. With its trendy design to match the Dive Master this rod will soon find many friends. The tough blank will take all the strain that occurs when trolling.

Code	Model	Length	Sections	C.W.	Tr.-Length	Weight
13019 210	Trolling Team Rigger Witch	2,10 m	2	12 - 20 lbs / 40 - 80 g	1,13 m	339 g
13019 240	Trolling Team Rigger Witch	2,40 m	2	12 - 20 lbs / 40 - 80 g	1,24 m	389 g

## TROLLING TEAM DIVE MASTER

Outstanding for pike and salmon trolling. When it comes to the crunch with divers the rod stands the test with the necessary stiff backbone. The sensitive tip will subdue even lightly hooked opponents during the fight. Perhaps the best rod ever to come to market for this area of angling. Also excellent for piking with a multiplier reel.

Code	Model	Length	Sections	C.W.	Tr.-Length	Weight
13019 285	Trolling Team Dive Master	2,85 m	2	15 - 30 lbs / 50 - 130 g	1,50 m	378 g

## TROLLING XTRA

A workhorse for novices. The rock-solid blank is ideal for trolling for cod, sea trout and salmon. The fibreglass in the blank provides the necessary buffering properties and makes the rod impervious to the everyday stresses of trolling.

Code	Model	Length	Sections	C.W.	Tr.-Length	Weight
13020 240	Trolling Xtra	2,40 m	2	40 - 80 g / 12 - 20 lbs	1,24 m	392 g







### RHINO STEEL TRACE

Nylon-coated, with a barrel-type swivel and a safety swivel

Code	Model	Length	Ø	BS	Content
2305 006	1x7	0,3 m	0,24 mm	6 kg	2 pcs
2305 009	1x7	0,3 m	0,27 mm	9 kg	2 pcs
2305 013	1x7	0,3 m	0,33 mm	13 kg	2 pcs
2306 006	1x7	0,5 m	0,24 mm	6 kg	2 pcs
2306 009	1x7	0,5 m	0,27 mm	9 kg	2 pcs
2306 013	1x7	0,5 m	0,33 mm	13 kg	2 pcs
2306 017	1x7	0,5 m	0,39 mm	17 kg	2 pcs
2307 009	1x7	0,7 m	0,27 mm	9 kg	2 pcs
2307 013	1x7	0,7 m	0,33 mm	13 kg	2 pcs
2307 017	1x7	0,7 m	0,39 mm	17 kg	2 pcs

Trade Pack 10 Pieces



### RHINO STEEL TRACE

Nylon-coated, with a loop at both ends

Code	Model	Length	Ø	BS	Content
2316 005	1x7	0,7 m	0,21 mm	5 kg	2 pcs
2316 008	1x7	0,7 m	0,27 mm	8 kg	2 pcs
2316 012	1x7	0,7 m	0,33 mm	12 kg	2 pcs

Trade Pack 10 Pieces



### RHINO STEEL TRACE

Nylon-coated, with a loop and double hook

Code	Model	Hook Size	Length	Ø	BS	Content
4202 003	1x7	9	0,6 m	0,18 mm	3 kg	1 pcs
4202 005	1x7	7	0,6 m	0,21 mm	5 kg	1 pcs
4202 007	1x7	5	0,6 m	0,24 mm	7 kg	1 pcs
4202 009	1x7	2	0,6 m	0,27 mm	9 kg	1 pcs

Trade Pack 10 Pieces



### RHINO STEEL TRACE

Nylon-coated, with a loop and single hook

Code	Model	Hook Size	Length	Ø	BS	Content
4203 008	1x7	2	0,6 m	0,27 mm	8 kg	1 pcs
4203 012	1x7	1/0	0,6 m	0,33 mm	12 kg	1 pcs
4203 015	1x7	2/0	0,6 m	0,36 mm	15 kg	1 pcs

Trade Pack 10 Pieces



### RHINO STEEL TRACE

Nylon-coated, with a barrel swivel and safety swivel

Code	Model	Length	Ø	BS	Content
2317 009	1x7	0,5 m	0,27 mm	9 kg	2 pcs
2317 012	1x7	0,5 m	0,33 mm	12 kg	2 pcs
2317 015	1x7	0,5 m	0,36 mm	15 kg	2 pcs

Trade Pack 10 Pieces



### RHINO STEEL TRACE

Nylon-coated, with a loop and treble hook

Code	Model	Hook Size	Length	Ø	BS	Content
4201 005	1x7	8	0,6 m	0,21 mm	5 kg	1 pcs
4201 008	1x7	6	0,6 m	0,27 mm	8 kg	1 pcs
4201 012	1x7	5	0,6 m	0,33 mm	12 kg	1 pcs
4201 015	1x7	1	0,6 m	0,36 mm	15 kg	1 pcs

Trade Pack 10 Pieces



### RHINO STEEL TRACE

Nylon-coated, with a barrel swivel and safety swivel

Code	Model	Length	Ø	BS	Content
2318 005	7x7	0,5 m	0,34 mm	5 kg	2 pcs
2318 008	7x7	0,5 m	0,38 mm	8 kg	2 pcs
2318 012	7x7	0,5 m	0,42 mm	12 kg	2 pcs

Trade Pack 10 Pieces



### RHINO STEEL TRACE

Nylon-coated, with a barrel-type swivel and a safety swivel

Code	Model	Length	Ø	BS	Content
2310 006	7x7	0,3 m	0,35 mm	6 kg	2 pcs
2310 009	7x7	0,3 m	0,39 mm	9 kg	2 pcs
2310 013	7x7	0,3 m	0,45 mm	13 kg	2 pcs
2311 006	7x7	0,5 m	0,35 mm	6 kg	2 pcs
2311 009	7x7	0,5 m	0,39 mm	9 kg	2 pcs
2311 013	7x7	0,5 m	0,43 mm	13 kg	2 pcs
2311 017	7x7	0,5 m	0,45 mm	17 kg	2 pcs
2312 006	7x7	0,7 m	0,35 mm	6 kg	2 pcs
2312 009	7x7	0,7 m	0,39 mm	9 kg	2 pcs
2312 013	7x7	0,7 m	0,43 mm	13 kg	2 pcs
2312 017	7x7	0,7 m	0,45 mm	17 kg	2 pcs

Trade Pack 10 Pieces



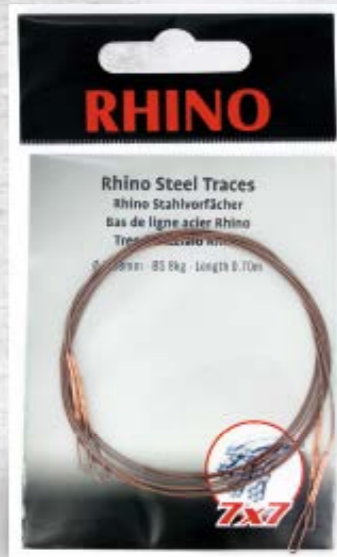

### RHINO STEEL TRACE

Nylon-coated, with a loop at both ends

Code	Model	Length	Ø	BS	Content
2324 005	7x7	0,5 m	0,34 mm	5 kg	2 pcs
2324 008	7x7	0,5 m	0,38 mm	8 kg	2 pcs
2324 012	7x7	0,5 m	0,42 mm	12 kg	2 pcs
2325 005	7x7	0,7 m	0,38 mm	5 kg	2 pcs
2325 008	7x7	0,7 m	0,34 mm	8 kg	2 pcs
2325 012	7x7	0,7 m	0,42 mm	12 kg	2 pcs

Trade Pack 10 Pieces



### RHINO STEEL TRACE

Nylon-coated, with a loop and treble hook

Code	Model	Hook Size	Length	Ø	BS	Content
4204 005	7x7	8	0,6 m	0,34 mm	5 kg	1 pcs
4204 008	7x7	6	0,6 m	0,38 mm	8 kg	1 pcs
4204 012	7x7	5	0,6 m	0,42 mm	12 kg	1 pcs
4204 015	7x7	1	0,6 m	0,45 mm	15 kg	1 pcs

Trade Pack 10 Pieces



### RHINO STEEL TRACE

Nylon-coated, with a loop and single hook

Code	Model	Hook Size	Length	Ø	BS	Content
4205 008	7x7	2	0,6 m	0,38 mm	8 kg	1 pcs
4205 012	7x7	1/0	0,6 m	0,42 mm	12 kg	1 pcs
4205 015	7x7	2/0	0,6 m	0,45 mm	15 kg	1 pcs

Trade Pack 10 Pieces



black shiner

black devil

beluga

copper blue dolphin

gold/green dolphin

rainbow trout

Swedish flag

king salmon

furuncle



### RHINO TROLLING SPOONS

You want to catch big fish, right? And you want to troll medium and large lures with the same speed? This is where Rhino Trolling Spoons really come into their own category. The lures have been specially designed by our trolling experts for trolling in the Baltic Sea. In open water and during the herring run, salmon and sea trout often prefer larger baits. We have put together an optimum range of colours for you whether you are fishing off Rügen, Fehmarn, Bornholm, Simrishamn or the Gulf of Finland – you will always be well prepared. The agile, almost aggressive swim action also attracts predators to take the bait at a trolling speed to match that used by most boats.

Length	Model	Weight	Content	black shiner	black devil	beluga	copper blue dolphin	gold/green dolphin	rainbow trout	Swedish flag	king salmon	furuncle	gold green dolphin
115 mm	MAG	16 g	1 pcs	3395 001	3395 002	3395 004	3395 005	3395 006	3395 008	3395 009	3395 010	3395 020	
150 mm	Xtra MAG	27 g	1 pcs	3395 101	3395 102	3395 104	3395 105		3395 108	3395 109	3395 110	3395 120	3395 106

Trade Pack 5 Pieces





## RHINO TROLLING SPOONS

You want to catch big fish, right? And you want to troll medium and large lures with the same speed? This is where Rhino Trolling Spoons really come into their own category. The lures have been specially designed by our trolling experts for trolling in the Baltic Sea. In open water and during the herring run, salmon and sea trout often prefer larger baits. We have put together an optimum range of colours for you whether you are fishing off Rügen, Fehmarn, Bornholm, Simrishamn or the Gulf of Finland – you will always be well prepared. The agile, almost aggressive swim action also attracts predators to take the bait at a trolling speed to match that used by most boats.

Length	Model	Weight	Content	rügen	copper master herring	gold swedish flag	svenstrup special	natural copper blue dolphin	last try	super shiner
115 mm	MAG	16 g	1 pcs	3395 031	3395 032	3395 034	3395 035	3395 037	3395 046	3395 047
150 mm	Xtra MAG	27 g	1 pcs	3395 131	3395 132	3395 134	3395 135	3395 137	3395 146	3395 147

Trade Pack 5 Pieces

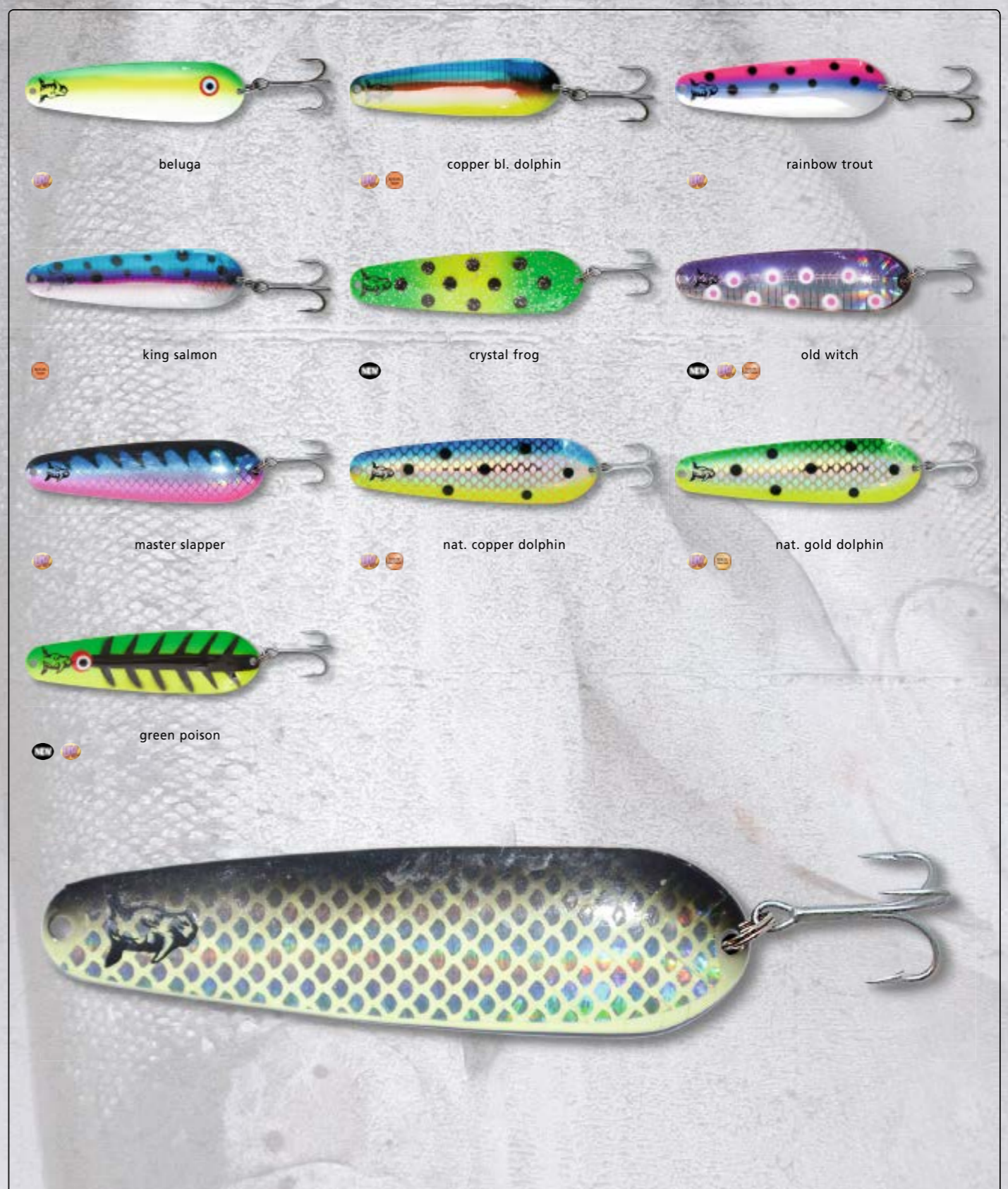

## RHINO TROUT KILLER

At last, we can offer the alluring Rhino spoon in a size specially designed for sea trout, which prefer a smaller lure fished close to the shore. In the new Trout Killer Spoon range, we are offering a tailor-made spoon and colour concept specially designed for sea trout sport. The retrieve action of the spoons ranges from agile to aggressive while the speed has been optimally matched to the other spoons in the Rhino range. Don't forget to try this lure for salmon at depth when small sprats are on the menu for the fish! Many a 10-kg salmon has already given in to the temptation.

Length	Weight	Content	beluga	copper bl. dolphin	rainbow trout	king salmon	crystal frog	old witch	master slapper	nat. copper dolphin	nat. gold dolphin	green poison
85 mm	12 g	1 pcs	3397 004	3397 005	3397 008	3397 010	3397 016	3397 029	3397 030	3397 037	3397 038	3397 048

Trade Pack 5 Pieces

kompletný cenník na [www.SPORTS.sk](http://www.SPORTS.sk), výhradný distribútor pre SR: SPORTS s.r.o.



**RHINO XTRA SLIM**

Besides the colour, the shape is obviously also important. When the fish are fixated with sand eels, this trolling lure comes into its own. A perfect imitation of a Toby in its shape, action and colours.

Length	Weight	Content	black devil	sandeel	blue/silver	beluga	black gold angel	gold green dolphin	rainbow	king salmon
150 mm	19 g	1 pcs	3378 002	3378 026	3378 027	3378 004	3378 017	3378 006	3378 008	3378 010

Trade Pack 5 Pieces

**RHINO LAX SPOON**

A tried and trusted design. It is difficult to go wrong with this trolling spoon in terms of retrieval speed. With a slow retrieve, it wobbles alluringly, and with a faster retrieve the spoon kicks quickly without rotating. We are sure many a trolling fan will be adding this design to his lure box alongside previous Rhino spoons.

Length	Model	Weight	Content	black devil	beluga	gold green dolphin	rainbow trout	king salmon	pink sunshine	furuncle	firetiger	sandeel
115 mm	L	12 g	1 pcs	3398 002	3398 004	3398 006	3398 008	3398 010	3398 019	3398 020	3398 023	3398 026
150 mm	XL	18 g	1 pcs	3398 102	3398 104	3398 106	3398 108	3398 110	3398 119	3398 120	3398 123	3398 126

Trade Pack 5 Pieces



kompletný cenník na [www.SPORTS.sk](http://www.SPORTS.sk), výhradný distribútor pre SR: SPORTS s.r.o.





### RHINO LAX SPOON

A tried and trusted design. It is difficult to go wrong with this trolling spoon in terms of retrieval speed. With a slow retrieve, it wobbles alluringly, and with a faster retrieve the spoon kicks quickly without rotating. We are sure many a trolling fan will be adding this design to his lure box alongside previous Rhino spoons.

Length	Model	Weight	Content	copper master herring	gold swedish flag	natural copper blue dolphin	last try	super shiner	Swedish dream
115 mm	L	12 g	1 pcs	3398 032	3398 034	3398 037	3398 046	3398 047	3398 049
150 mm	XL	18 g	1 pcs	3398 132	3398 134	3398 137	3398 146	3398 147	3398 149

Trade Pack 5 Pieces

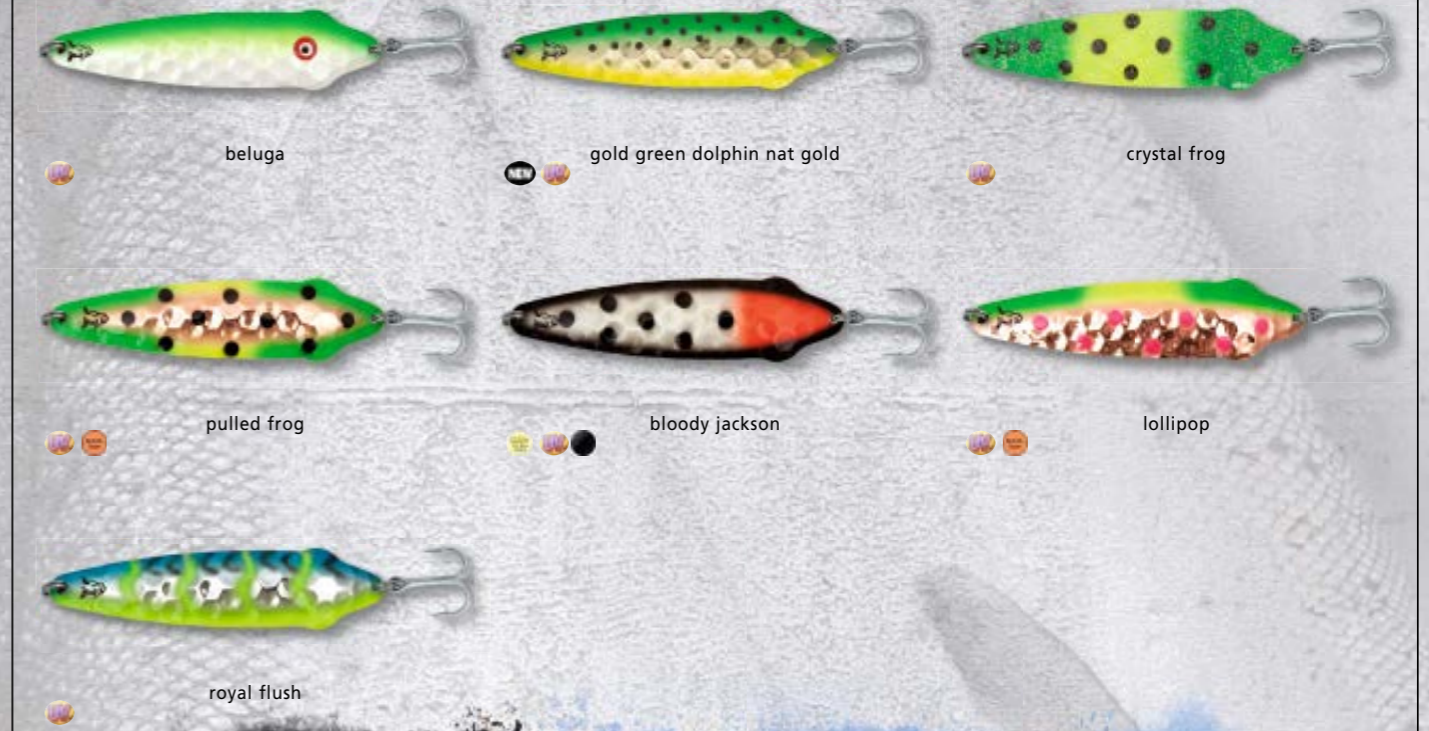

### FREDDI FLUTTER

Ultra-agile flutter spoon for trolling for cod, sea trout and salmon. The honeycomb structure provides tantalising light reflexes, which, combined with the colour designs put together by the Rhino trolling team, make the Freddi Flutter irresistible. And as a total innovation for the market, the model is also available as an ultra-large 190 mm salmon spoon, always a tremendous asset when the silver torpedoes are preying on herring. Every angler should always have an adequate supply of both sizes on board.

Length	Model	Weight	Hook Size	beluga	gold green dolphin nat gold	crystal frog	pulled frog	bloody jackson	lollipop	royal flush
110 mm	L	12 g	1/0	3373 004	3373 006	3373 016	3373 039	3373 040	3373 041	3373 042
145 mm	XL	20 g	4/0	3373 104	3373 106	3373 116	3373 139	3373 140	3373 141	3373 142
190 mm	XXL	30 g	4/0	3373 204	3373 206	3373 216	3373 239	3373 240	3373 241	3373 242

Trade Pack 5 Pieces

kompletný cenník na [www.SPORTS.sk](http://www.SPORTS.sk), výhradný distribútor pre SR: SPORTS s.r.o.



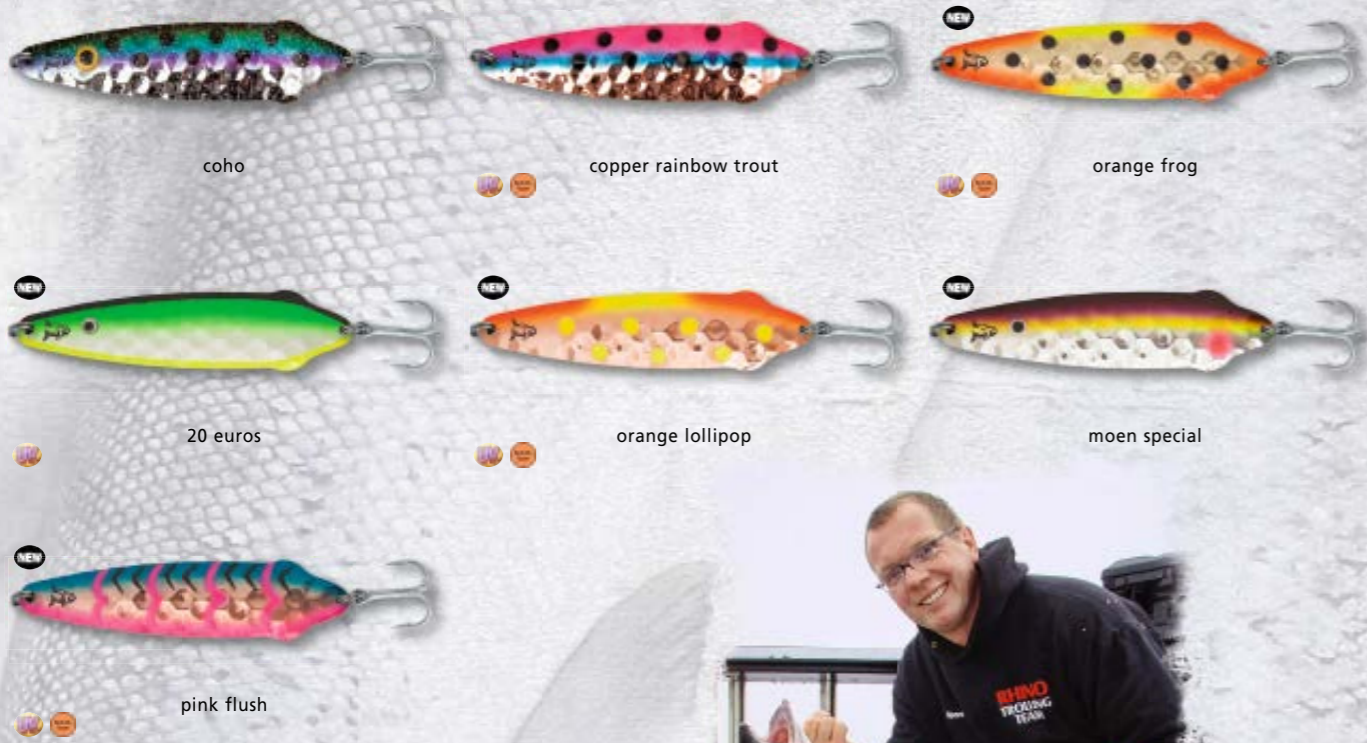

### FREDDI FLUTTER

Ultra-agile flutter spoon for trolling for cod, sea trout and salmon. The honeycomb structure provides tantalising light reflexes, which, combined with the colour designs put together by the Rhino trolling team, make the Freddi Flutter irresistible. And as a total innovation for the market, the model is also available as an ultra-large 190 mm salmon spoon, always a tremendous asset when the silver torpedoes are preying on herring. Every angler should always have an adequate supply of both sizes on board.

Length	Model	Weight	Hook Size	coho	copper rainbow trout	orange frog	20 euros	orange lollipop	moen special	pink flush
110 mm	L	12 g	1/0	3373 043	3373 045	3373 050	3373 051	3373 053	3373 054	3373 056
145 mm	XL	20 g	4/0	3373 143	3373 145	3373 150	3373 151	3373 153	3373 154	3373 156
190 mm	XXL	30 g	4/0	3373 243	3373 245	3373 250	3373 251	3373 253	3373 254	3373 256

Trade Pack 5 Pieces



### SALMON DOCTOR

An unusually heavy trolling spoon with a somewhat thicker blade and a fascinating, unconventional action. This is explained by the fact that the Salmon Doctor is mounted with the wide area of the spoon facing the swivel while the narrow end faces the hook. The action is fundamentally different from that of other standard trolling spoons, making it successful when the fish have simply seen other models far too often. With its additional weight, the Salmon Doctor is also outstandingly suited to long lining or on planer boards.

Length	Model	Weight	Hook Size	beluga	king salmon	crystal frog	natural copper blue dolphin	pulled frog	bloody jackson	mette	royal flush
110 mm	M	22 g	2/0	3374 004	3374 010	3374 016	3374 037	3374 039	3374 040	3374 041	3374 042
132 mm	L	31 g	3/0	3374 104	3374 110	3374 116	3374 137	3374 139	3374 140	3374 141	3374 142
156 mm	XL	41 g	4/0	3374 204	3374 210	3374 216	3374 237	3374 239	3374 240	3374 241	3374 242

Trade Pack 5 Pieces

kompletný cenník na [www.SPORTS.sk](http://www.SPORTS.sk), výhradný distribútor pre SR: SPORTS s.r.o.





master herring



gold green dolphin



UV watermelon

New version!



gold swedish flag



king salmon



last try



wake up



copper head

New size „small“ available!

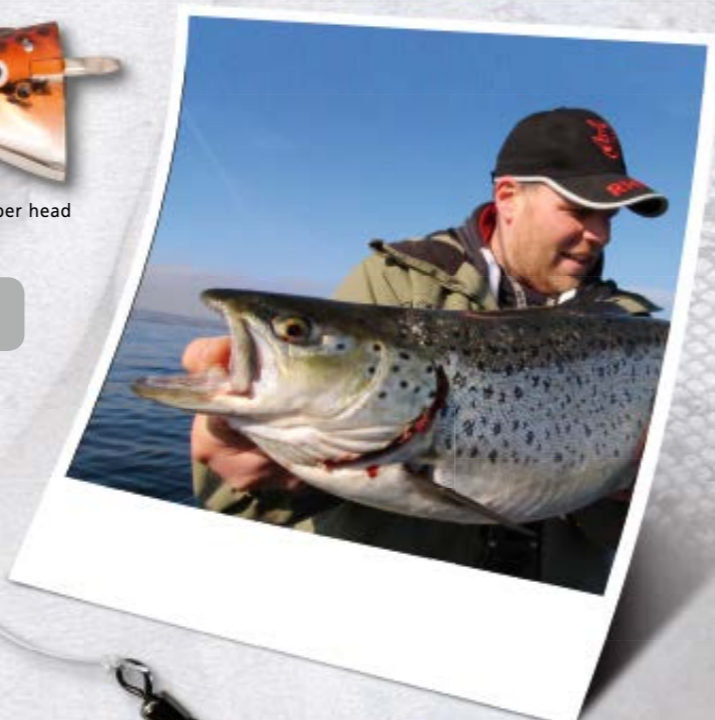

Delivered unassembled without hook and swivel.

### RHINO BAIT HOLDER

We have added a natural bait system into the Rhino Bait Holder range that immediately convinced us in practical testing on the Baltic Sea: The range comprises natural bait heads in two sizes and ten colours: The heads were developed by Mika Kampmann and are based upon real fish. It is the combination of accuracy and alluring bait action that makes this system so exceptional. No effort is required when it comes to set-up in almost all cases. The large head has been tailor made for herring and the smaller model for roach and similar species. Using both heads allows a broad range of various deadbaits (10 - 28cm) to be brought to bear. When it came to selecting colours, we called upon both the tried and trusted Rhino colours as well as recommendations from experience with natural bait systems. Ideal bait sizes: Rhino Bait Holder Medium: e.g. Roach from 10-13 cm Rhino Bait Holder Large: e.g. Herring from 18-23 cm

Model	Content	master herring	gold green dolphin	UV watermelon	gold swedish flag	king salmon	last try	wake up	copper head
Medium	3 pcs	4285 004	4285 005	4285 006	4285 007	4285 009	4285 010	4285 011	4285 012
Small	3 pcs	4285 204	4285 205	4285 206	4285 207	4285 209	4285 210	4285 211	4285 212

Trade Pack 5 Pieces



black shiner



ambulance



gold swedish flag



king salmon



black glitter



gold/green dolphin



rainbow trout



### SOFTFISH LURE

At last, an attractive rubber bait to fish behind flashers and dodgers. The transparent matrix enables highly attractive colour effects, which we offer in the tried and trusted Rhino Trolling Spoon designs.

Length	Weight	Content	black shiner	ambulance	gold swedish flag	king salmon	black glitter	gold/green dolphin	rainbow trout
10,5 cm	12 g	3 pcs	3375 001	3375 002	3375 003	3375 004	3375 005	3375 006	3375 007

Trade Pack 5 Pieces

kompletný cenník na [www.SPORTS.sk](http://www.SPORTS.sk), výhradný distribútor pre SR: SPORTS s.r.o.





New XL size available!



### FLASHER WITH SOFTFISH LURE

Provides a high contrast when fishing in the depths. Extremely successful for many years, this colour combination is now available in a flasher combi.

Length	Weight	Content	Hook Size	Leader L. Ø	black shiner	gold swedish flag	king salmon	gold/green dolphin	rainbow trout	michael jackson	ambulance
20 cm	85 g	1 pcs	1/0	0,60 mm	3376 001	3376 002	3376 003	3376 004	3376 005	3376 006	3376 007
28 cm	105 g	1 pcs	1/0	0,60 mm	3376 101	3376 102	3376 103	3376 104	3376 105	3376 106	3376 107

Trade Pack 5 Pieces



NEW

Stops the line twist!

### ANTI KINK

A trolling aid that reliably prevents line twist. And, thanks to a wide variety of designs, also an effective attractor. Can be used above spoons or natural bait rigs.

Length	Content	master herring	gold swedish flag	black devil	king salmon	gold green dolphin	glow black shiner	last try	fire angel
115 mm	1 pcs	6231 001	6231 002	6231 003	6231 004	6231 005	6231 006	6231 007	6231 008

Trade Pack 5 Pieces

### SALMON TRACKER

Perfectly functioning planer in aluminium and with a stainless steel arm. The EVA foam body reliably prevents unwanted diving in the waves. The clip holds the line securely in position but releases on the bite so that the planer does not create any more pressure during the fight. Extensive testing was performed to achieve an optimal shearing effect. Sold as a pair with one planer for the port side and another for the starboard side. A piece of cake to set up. 2 Pcs (right and left version) in Box.

Code	Length	Content	Colour
6329 006	25 cm	2 pcs	fluo yellow

Trade Pack 5 Pieces

NEW



Trolling Clip with Pin page R25

kompletný cenník na [www.SPORTS.sk](http://www.SPORTS.sk), výhradný distribútor pre SR: SPORTS s.r.o.





### PRO STOW BOX

A revival of the hugely successful lure box, specially designed for trolling anglers: much demanded, designed in collaboration with Mike Luner and capable of accommodating all types of lure – whether spoons, wobblers or pirkers – in separate compartments. The box combines a range of benefits: • Numerous lures (up to 20 cm long) can be transported together. • Clearly arranged storage. • Prevents lures from tangling • Lures are not thrown together, even if the box is tipped over. • Lures are no longer left in wet compartments the water drips down below. The box dries out when the lid is left open and the inserts can be removed where required

Code	Width	Height	Depth
8024 001	21 cm	24 cm	42 cm



### PARAVAN, LEAD FREE

Head weights deliver the bait to the desired depth, enabling effective angling at a variety of water depths. Customary paravanes, however, have a distinct disadvantage. They require a leader and the leader is dependent on the length of the rod to enable you to still land the fish. Not so with the Rhino Paravan. This clip-on weight can attach anywhere to the line without causing damage. It neither affects the agile behaviour of the bait, nor alarms the fish because seaweed has become tangled up with it etc. All of this means less time with the rod in your hand than without the Rhino Paravan.

Code	Weight	Content	Colour
6037 202	15 g	2 pcs	mat grey
6037 203	25 g	2 pcs	mat grey
6037 204	40 g	1 pcs	mat grey
6037 205	55 g	1 pcs	mat grey
6037 206	75 g	1 pcs	mat grey

Trade Pack 5 Pieces



### CLIP ON WEIGHT LEAD-FREE

Lead-free additional weights for trolling. Simple to clip onto the line and remove again. The clip has an internal securing pin, which reliably prevents falling off.

Code	Weight	Content
6232 001	20 g	2 pcs
6232 002	40 g	2 pcs
6232 003	60 g	1 pcs
6232 004	80 g	1 pcs
6232 005	100 g	1 pcs
6232 006	140 g	1 pcs

Trade Pack 5 Pieces



### RHINO PARAVAN

Head weights deliver the bait to the desired depth, enabling effective angling at a variety of water depths. Customary paravanes, however, have a distinct disadvantage. They require a leader and the leader is dependent on the length of the rod to enable you to still land the fish. Not so with the Rhino Paravan. This clip-on weight can attach anywhere to the line without causing damage. It neither affects the agile behaviour of the bait, nor alarms the fish because seaweed has become tangled up with it etc. All of this means less time with the rod in your hand than without the Rhino Paravan.

Code	Weight	Content	Colour
6037 001	10 g	2 pcs	bright orange
6037 002	25 g	2 pcs	bright orange
6037 003	45 g	2 pcs	bright orange
6037 004	70 g	1 pcs	bright orange
6037 005	95 g	1 pcs	bright orange
6037 006	120 g	1 pcs	bright orange

Trade Pack 5 Pieces



### RHINO PARAVAN

Head weights deliver the bait to the desired depth, enabling effective angling at a variety of water depths. Customary paravanes, however, have a distinct disadvantage. They require a leader and the leader is dependent on the length of the rod to enable you to still land the fish. Not so with the Rhino Paravan. This clip-on weight can attach anywhere to the line without causing damage. It neither affects the agile behaviour of the bait, nor alarms the fish because seaweed has become tangled up with it etc. All of this means less time with the rod in your hand than without the Rhino Paravan.

Code	Weight	Content	Colour
6037 101	10 g	2 pcs	mat grey
6037 102	25 g	2 pcs	mat grey
6037 103	45 g	2 pcs	mat grey
6037 104	70 g	1 pcs	mat grey
6037 105	95 g	1 pcs	mat grey
6037 106	120 g	1 pcs	mat grey

Trade Pack 5 Pieces



### TROLLING CLIP WITH PIN

Small, simple pin for trolling, with a pin to prevent release. For inline boards or clip-on weights, for example.

Code	Content
6234 001	3 pcs

Trade Pack 10 Pieces



### UV TORCH

Ideal for checking the glowing properties of baits or "charging" glow-in-the-dark baits. Batteries: 3xAAA (not included).

Code	Weight
9895 005	35 g





**NEW**



New rhinosteel coating!



### RHINO SALMON GRIPPER

Ultra-sharp single hook with upstream swivel. Can be fished on a trolling spoon in place of a treble and often takes a firmer hold than treble hooks.

Code	Hook Size	Content	Colour
4466 200	2/0	5 pcs	rhinosteel
4466 400	4/0	5 pcs	rhinosteel
4466 600	6/0	5 pcs	rhinosteel

Trade Pack 5 Pieces



### RHINO XTRA ROD HOLDER

Made from robust plastic and designed to produce the lowest of production tolerances. Can be attached to the deck and has 12 rest positions with 360° rotation. Thanks to a built-in notch, the rod can only be set in one position and cannot shift into the other positions unwanted through shaking. The tilt mechanism is securely attached via fixed snap-in points and a robust adjuster bolt. The rod can be secured against jumping out via a rubber clamp. Weight: 400 g.

Code	Weight
8207 001	400 g



### RHINO XTRA TUBE ROD HOLDER

Deck holder as with the Standard Xtra Rod Holder 8207 001, but with a fitted tube rod holder in polished aluminium. Rods can be taken out at great speed. The upper tube edge is designed to protect the rod handle with a soft plastic sleeve. With anti-twist device for rods with cross slots. The tilt mechanism is securely attached via fixed snap-in points and a robust adjuster bolt. Height: 30 cm. Weight: 530 g.

Code	Height	Weight
8207 002	30 cm	530 g



### RHINO ALU TURN&TILT RAILING ROD HOLDER

Fixed tube rod holder in polished aluminium. Rods can be taken out at great speed. The upper tube edge is designed to protect the rod handle with a soft plastic sleeve. With anti-twist device for rods with cross slots. For horizontal railing mounting via a super robust railing adapter (4 bolts, supplied). Suitable for 25 mm / 1" railing bars. Height: 30 cm. Weight: 740 g.

Code	Height	Weight
8208 003	30 cm	740 g



### RHINO XTRA ROD RACK, 3 RODS

Three rod holder in shock resistant white plastic. Mounted with 6 stainless steel bolts (supplied). The bracket has additional storage capacity, e.g. for forceps and fishing knives. Dimensions: 45 x 30 cm. Weight: 830 g

Code	Width	Height	Weight
8209 001	45 cm	30 cm	830 g



### RHINO ALU TURN&TILT RAILING ROD HOLDER

Like 8208 001, only for rail mounting via a super robust railing adapter (4 bolts, supplied). Suitable for 25 mm / 1" railing bars. Height: 30 cm. Weight: 1,080 g.

Code	Height	Weight
8208 002	30 cm	1080 g





## RHINO VX ELECTRIC OUTBOARD MOTOR

Strong, stronger, Rhino VX! Introducing one of the most powerful electric outboard motors on the market. The Rhino VX is outstanding in its low power consumption, allowing it to be used for longer periods with regular battery capacity. The motor is operated and steered with a telescopic tiller offering 5 forward and 2 reverse speeds. The motor can be tilted up by pushing a button and the depth of the prop as well as steering counterforce are continuously adjustable. With battery indication to prevent any loss of power scenarios. The Rhino VX features exceptionally simple, comfortable and safe overall handling. This electric outboard motor has become a reliable companion to thousands of boat anglers.

- With loading check display
- With steel shaft
- Extremely low energy consumption

Code	Model	Weight	Speeds	Max. weight of boat	Shaft Length	Length of Battery cable	Volt
9925 034	Rhino VX 34	6,70 kg	5V/2R	1100 kg	0,78 m	1,45 m	12
9925 044	Rhino VX 44	9,55 kg	5V/2R	1350 kg	0,78 m	1,6 m	12
9925 054	Rhino VX 54	10,00 kg	5V/2R	1750 kg	0,78 m	1,6 m	12
9925 065	Rhino VX 65	10,00 kg	5V/2R	2100 kg	0,78 m	1,70 m	12

The length of the motor shaft is equal to the distance between the control head and the submerged drive unit.

## RHINO VX ACCESSORIES

Code	Model	Motor
9925 601	Part 1 Top Cover Assembly with display	VX28/34/44/54/65
9925 701	Part 1 Top Cover Assembly	VX80
9925 602	Part 2 Screw, 2pcs, all sizes	VX28/34/44/54/80
9925 603	Part 3 Handle Retainer Clamp (top)	VX28/34/44/54/65/80
9925 604	Part 4 Switch 5-Speed	VX28
9925 704	Part 4 Switch 5 Speed	VX28/34/44/54/65
9925 605	Part 5 Handle Retainer Clamp (Bottom)	VX28/34/44/54/80
9925 606	Part 6 Fixing Wire Retainer	VX28/34/44/54/80
9925 607	Part 7 Bottom Cover	VX28/34/44/54
9925 707	Part 7 Bottom Cover	VX80
9925 608	Part 8 Screw	VX28/34/44/54/65/80
9925 609	Part 9 Lock Nut	VX28/34/44/54/65/80
9925 610	Part 10 Screw, 5pcs	VX28/34/44/54/65/80
9925 611	Part 11 Depth Collar Assy	VX28/34/44/54
9925 711	Part 11 Depth Collar Assy	VX80
9925 612	Part 12 Mount Assembly	VX28/34
9925 712	Part 12 Mount Assembly	VX44/54
9925 812	Part 12 Mount Assembly	VX80
9925 912	Part 12 Mount Assembly	VX65
9925 613	Part 13 Tension Block Screw	28/34/44/54/65
9925 713	Part 13 Tension Block Screw	VX80
9925 614	Part 14 Pin, 5pcs	VX28/34/44/54/65
9925 714	Part 14 Pin	VX80
9925 615	Part 15 Prop Nut	VX28/34/44/54/80
9925 616	Part 16 Prop, 2 blades	VX28/34
9925 716	Part 16 Prop, 3 blades	VX44/54/65
9925 816	Part 16 Prop, 3 blades	VX80
9925 618	Part 18 Faucet disc	VX28/34/44/54/65/80
9925 619	Part 19 Screw	VX28/34/44/54/65/80
9925 620	Part 20 Key washer	VX28/34/44/54/65/80
9925 621	Part 21 Insulating Sleeve	VX28/34/44/54/65/80
9925 622	Part 22 Battery Cable Assy	VX28/34
9925 722	Part 22 Battery Cable Assy	VX44/54
9925 822	Part 22 Battery Cable Assy	VX80
9925 922	Part 22 Battery Cable Assy	VX65
9925 623	Part 23 Battery Cable Clip	VX28/34/44/54/65/80

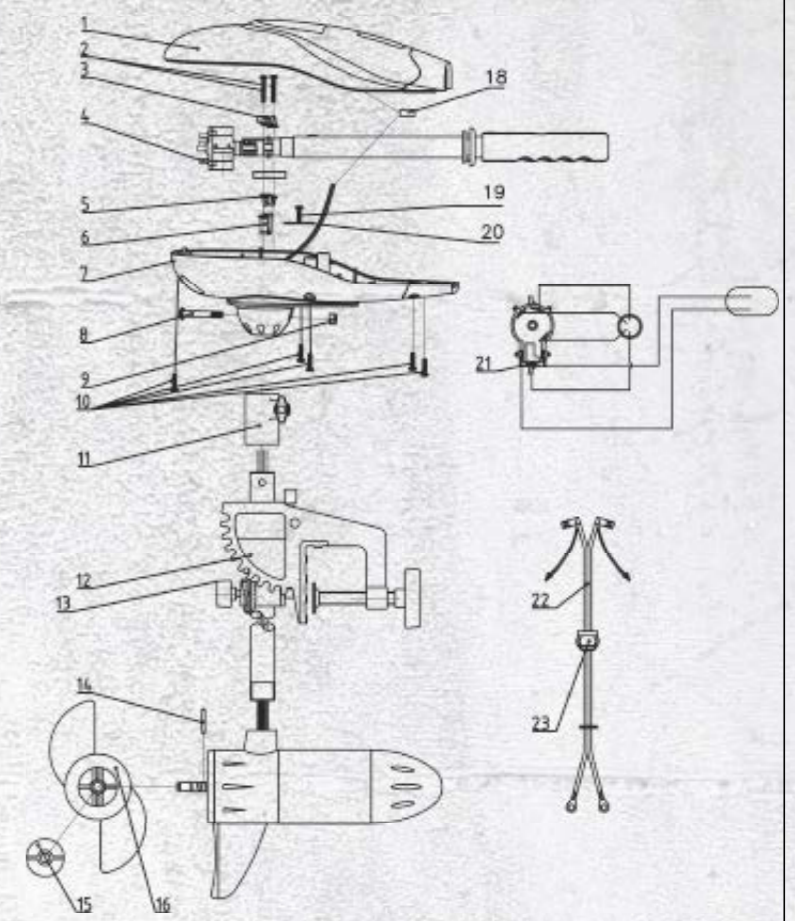

## THE TECHNICAL SPECS

Description	Ampere consumption per speed /Peak (initial voltage)	Watt per speed	Thrust (lbs)	Thrust (kp)
VX-34	1st speed: 9 A	77	6.6 lbs	3.00 kp
	2nd speed: 11 A	101	7.4 lbs	3.40 kp
	3rd speed: 16 A	139	13.2 lbs	6.00 kp
	4th speed: 20 A	162	15.8 lbs	7.20 kp
	5th speed: 40 A	215	34.0 lbs	15.40 kp
VX-44	1st speed: 12 A	105	8.8 lbs	4.00 kp
	2nd speed: 14 A	126	11.0 lbs	5.00 kp
	3rd speed: 25 A	220	22.0 lbs	10.00 kp
	4th speed: 28 A	237	25.9 lbs	11.80 kp
	5th speed: 52 A	290	44.0 lbs	20.00 kp
VX-54	1st speed: 16 A	147	9.25 lbs	4.20 kp
	2nd speed: 18 A	167	11.45 lbs	5.20 kp
	3rd speed: 34 A	270	22.47 lbs	10.20 kp
	4th speed: 38 A	290	26.43 lbs	12.00 kp
	5th speed: 55 A	320	54.00 lbs	24.50 kp
VX-65	1st speed: 11 A	100	10 lbs	4.60 kp
	2nd speed: 16 A	138	14 lbs	6.40 kp
	3rd speed: 20 A	170	27 lbs	12.30 kp
	4th speed: 28 A	255	35 lbs	16.00 kp
	5th speed: 50 A	420	65 lbs	29.50 kp



kompletný cenník na [www.SPORTS.sk](http://www.SPORTS.sk), výhradný distribútor pre SR: SPORTS s.r.o.





## RHINO BLX 70 ELECTRIC OUTBOARD MOTOR

Powerful electric outboard motor with 70lb of thrust at a voltage of 12V. Corresponds to roughly 2 H.P. Maintenance-free design, since no graphite brushes are used as collectors. The so-called S mode (which is activated via the Sport Mode button) brings the motor to maximum performance directly however, it is also possible to use the Vario Speed feature to adjust the speed continuously in forward or reverse. When the motor is running, the display shows the battery condition. The motor also features a USB connector for charging phones or lamps. The tiller is extractable its shaft is made of stainless steel. It folds up by means of a lever. Both the propeller depth in the water and the steering pressure are continuously adjustable. An essential piece of equipment for demanding boat anglers.

Code	Weight	Speeds	Max. weight of boat	Shaft Length	Length of Battery cable	Volt
9930 070	12,2 kg	Vario	2000 kg	0,91 m	2,00 m	12

The length of the motor shaft is equal to the distance between the control head and the submerged drive unit.

## RHINO BLX ACCESSORIES

- 9930 101 Part 1 Prop
- 9930 102 Part 2 Prop nut
- 9930 103 Part 3 Washer
- 9930 104 Part 4 Motor unit
- 9930 105 Part 5 Wire protective sleeve
- 9930 106 Part 6 Shaft
- 9930 107 Part 7 Mount Assy
- 9930 108 Part 8 Depth Collar Assy
- 9930 109 Part 9 Screw
- 9930 110 Part 10 Sealing ring
- 9930 111 Part 11 Clamp
- 9930 112 Part 12 Screw
- 9930 113 Part 13 Locking nut
- 9930 114 Part 14 Bushing
- 9930 115 Part 15 Bolt
- 9930 116 Part 16 Bottom cover
- 9930 117 Part 17 USB step-down controller
- 9930 118 Part 18 Connector
- 9930 119 Part 19 Potentiometer assembly (two)
- 9930 120 Part 20 Locking Washer
- 9930 121 Part 21 Fixed frame
- 9930 122 Part 22 Wire guard
- 9930 123 Part 23 Top Cover Assy
- 9930 124 Part 24 Fixing clamp (top)
- 9930 125 Part 25 Fixing clamp (bottom)
- 9930 126 Part 26 Spring
- 9930 127 Part 27 Connecting shaft
- 9930 128 Part 28 Handle Assy
- 9930 129 Part 29 Screw
- 9930 130 Part 30 Spring
- 9930 131 Part 31 Water joint
- 9930 132 Part 32 Seal cover
- 9930 133 Part 33 Rubber plug
- 9930 134 Part 34 Connector shell
- 9930 135 Part 35 Main battery cable

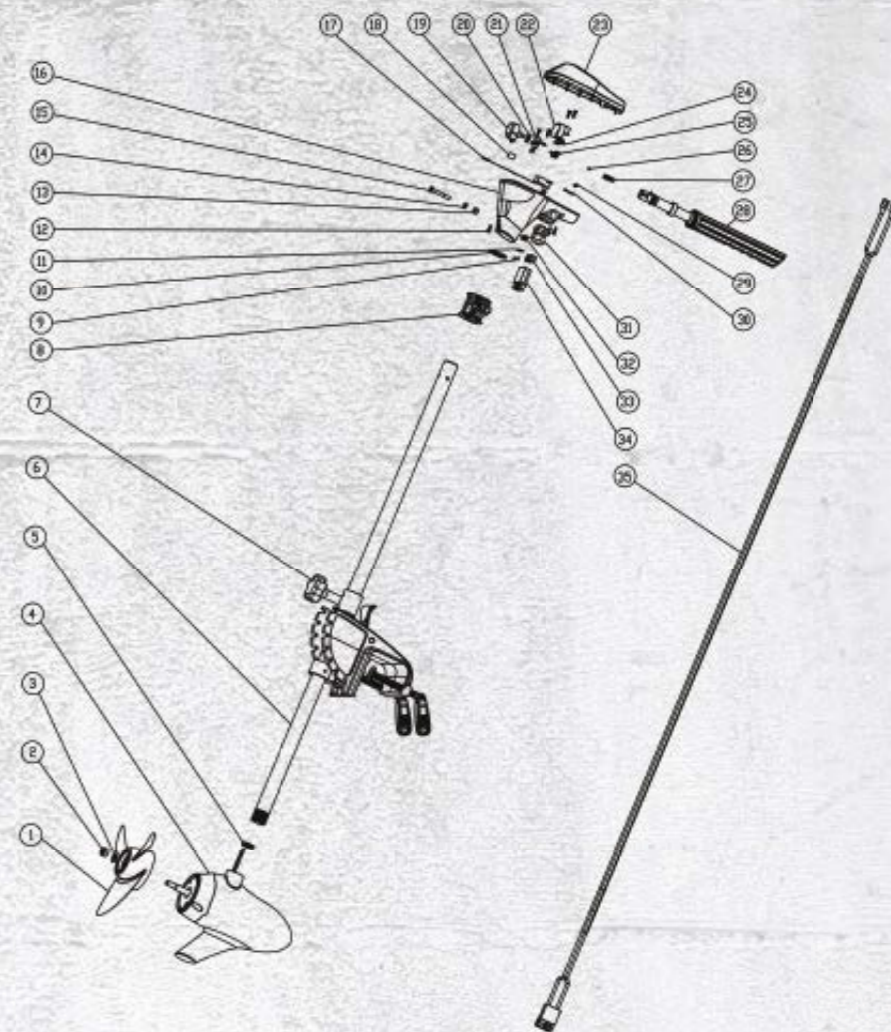

## THE TECHNICAL SPECS

Electric current (A)	Output (W)	Revs per minute (rpm)
7,34	88,99	2382
9,20	111,5	2349
12,9	156,9	2286
17,7	214,9	2201
24,4	296,4	2092
33,3	403,7	1967
43,4	525,9	1833
57,1	691,9	1685
64,1	776,8	1342

Data determined on a dynamometer.





Always keeping you moving....



## RHINO COBOLD OUTBOARD MOTOR

Small and manageable but effective. With its 18 lb of thrust the Cobold is designed for use with dinghies or canoes. Like its big brother, the Cobold boasts optimal power consumption enabling longer operation for the same battery capacity. Features a switch for 'forwards', 'off' and 'backwards', also offers a choice of two speeds. The propeller depth in the water and steering pressure are continuously adjustable via screws. The tiller can be lowered into the motor head to save space during transport. Finally, the shaft comes with an ingenious fastener allowing the motor to fold up should it come up against any obstacles. Overall the Rhino Cobold handles easily, comfortably and safely.

Code	Weight	Speeds	Max. weight of boat	Shaft Length	Length of Battery cable	Volt
9921 018	2,45 kg	2V/2R	500 kg	0,60 m	1,60 m	12

Trade Pack 2 Pieces

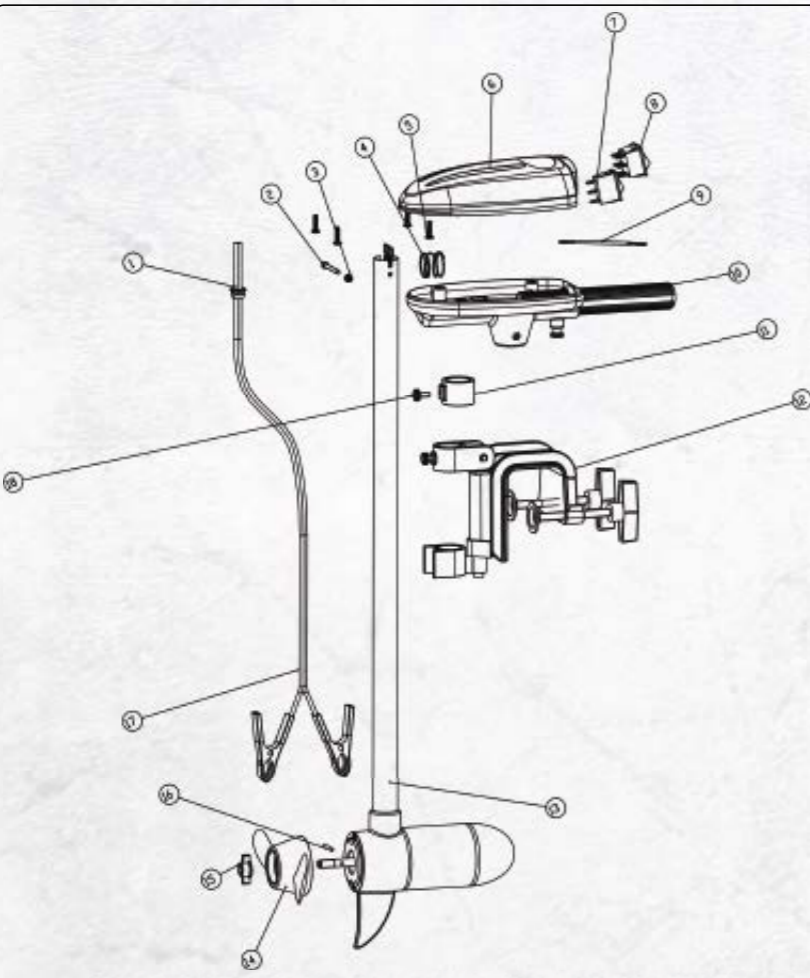

## RHINO COBOLD ACCESSORIES

Code	Model
9921 101	Part 1 battery cable clip
9921 102	Part 2 screw
9921 103	Part 3 locking nut
9921 104	Part 4 spring
9921 105	Part 5 screw 4pcs
9921 106	Part 6 top cover
9921 107	Part 7 switch
9921 108	Part 8 switch
9921 109	Part 9 wire assembly
9921 110	Part 10 bottom cover assy
9921 111	Part 11 depth collar assy
9921 112	Part 12 mount assembly
9921 113	Part 13 motor assembly
9921 114	Part 14 propeller
9921 115	Part 15 prop nut
9921 117	Part 17 main battery cable
9921 118	Part 18 screw
9921 119	Part 19 carbon brush 2pcs

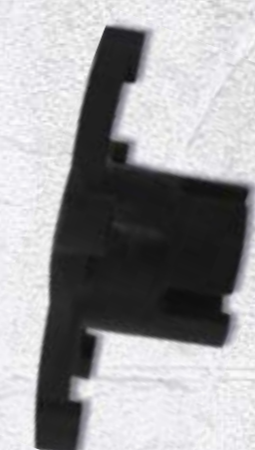

### PROP KEY

Code	Model
9925 395	Thunder/VX



### REPAIR KITS

With all important spare parts.

Code	Model
9925 930	Repair Kit Rhino VX28
9925 931	Repair Kit Rhino VX34
9925 932	Repair Kit Rhino VX44
9925 933	Repair Kit Rhino VX54
9925 934	Repair Kit Rhino VX80
9925 941	Repair Kit Rhino Cobold
9925 954	Repair Kit Rhino VX65



### MOTOR FUSES

Code	Model	Motor
9925 947	Set 40A	VX28/34
9925 950	40A	VX28/34
9925 951	50A	VX44/54/T4/T5



### SWITCH 5-SPEED

VX 28 (current) + 34-54 (Serial No. under 58397)

Code	Model
9925 604	Part 4 Switch 5-Speed



### SWITCH 5-SPEED

VX 34-54 (current models, Serial No. from 58397)

Code	Model
9925 704	Part 4 Switch 5 Speed



### REPAIR KITS

VX 34-54 (Serial No. under 58397)

Code	Model
9925 804	Speed Control Switch Upgrade Kit VX34-54



### PROP-SET

With a choice of a two or three blade propeller, supplied with a shear pin and fixing screw.

Code	Model
9925 397	VX28 / VX34
9925 398	VX44 / VX54 / T4 / T5
9925 399	VX80 / T8





# RHINO

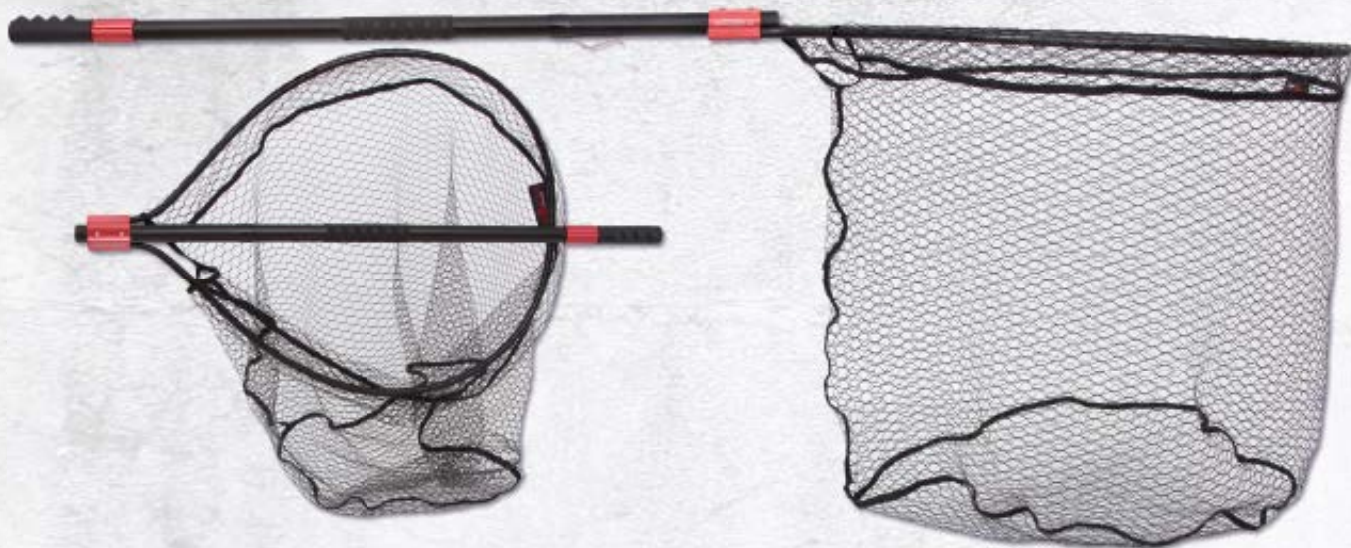

## PREDATOR LANDING NET

Super-robust predator landing net with all-round metal frame. The rubberised mesh provides optimal protection for the fish and dries in no time. Available in the two most popular sizes!

Code	Length	Width	Height	Size	Material	Tr.-Length	Mesh
7003 240	2,40 m	60 cm	70 cm	XL	Rubber Net	1,05 m	24 x 16 mm
7003 255	2,55 m	80 cm	90 cm	XXL	Rubber Net	1,05 m	24 x 16 mm



## RHINO CAP

Material: 100% Cotton

Code	Colour
9788 072	black

Trade Pack 5 Pieces



## MEASURE TAPE STICKER

Special high-tech boat sticker with certified seawater resistance. Highly UV-resistant thanks to the use of screen printing. The UV resistance lasts several years depending on use and the intensity of the actual radiation. Material: Polychlorid adhesive film, P4 polyacrylate high-tech adhesive with certified seawater resistance

Code	Width	Height
9949 038	119 cm	12,4 cm

Trade Pack 5 Pieces



## RHINO STICKER

With Rhino motif. black/red

Code	Width	Height
9949 039	20 cm	7 cm

Trade Pack 10 Pieces



## RHINO STICKER

Code	Width	Height
9971 958	42 cm	10 cm

kompletný cenník na [www.SPORTS.sk](http://www.SPORTS.sk), výhradný distribútor pre SR: SPORTS s.r.o.





**VAN STAAL®**



kompletný cenník na [www.SPORTS.sk](http://www.SPORTS.sk), výhradný distribútor pre SR: SPORTS s.r.o.



360°-View  
On Our Website!  
www.zebco-europe.com



# VR

Superb new Van Staal fixed spool reel series, called Van Staal VR, featuring fully-machined 6061-T6 waterproof aluminum body, sealed and waterproof drag system, spiral-bevel drive gear and pinion, MicroClick™ drag tuning accuracy, solid stainless steel center shaft with, titanium nitride coating and it includes kit for bail-less conversion.

Code		LINE CAPACITY MONO	LINE CAPACITY BRAID	GEAR RATIO	WEIGHT	LINE RETRIEVE	Ball Bearings
0610 125	Van Staal VR125	310 m / 0.22 mm	400 yds / 20 lbs	4.8:1	448 g	80 cm	13
0983 016	Spare Spool VR125						
0610 150	Van Staal VR150	330 m / 0.25 mm	440 yds / 30 lbs	4.8:1	453 g	87 cm	13
0983 017	Spare Spool VR150						
0610 175	Van Staal VR175	330 m / 0.30 mm	530 yds / 30 lbs	4.8:1	468 g	95 cm	13
0983 018	Spare Spool VR175						
0610 200	Van Staal VR200	365 m / 0.30 mm	500 yds / 40 lbs	4.8:1	482 g	102 cm	13
0983 019	Spare Spool VR200						



### Van Staal spiral gears

Huge, machined stainless steel spiral-bevel gears are used in all Van Staal spin reels. Individually cut out of hardened stainless steel, their design creates tremendous gear tooth contact between the main gear and the pinion. No gear works better under load.



### Van Staal Braid-Rated Clutch

This extra-large anti-reverse clutch offers rock-solid hooksets and the ability to use heavy braided lines with unyielding strength.

kompejný cenník na [www.SPORTS.sk](http://www.SPORTS.sk), výhradný distribútor pre SR: SPORTS s.r.o.



# ZEBCO®

**Top quality equipment for spinning, sea fishing, general coarse angling and specimen fishing with probably the best price performance ratio the market has to offer.**



kompletný cenník na [www.SPORTS.sk](http://www.SPORTS.sk), výhradný distribútor pre SR: SPORTS s.r.o.



**Reels**

Avalanche FD.....Z 3  
 Trophy Carver FD.....Z 4  
 Great White™.....Z 5  
 Cosmos MSG, Cosmos FD.....Z 6  
 S-Ray BR, BRN.....Z 7  
 Z-Cast FD.....Z 8  
 Saltfisher FD.....Z 9  
 Attac II.....Z10  
 Stinger, Cool X RD.....Z 11  
 Cool CS RD & FD.....Z 12  
 Saltfisher Surf, Cool Red Surf FD.....Z 13  
 Cool Patriot, Lite FD.....Z 14  
 Saltfisher Trolling, Cool Trolling LH.....Z 15  
 Great White™ Trolling, Great White™ Boat.....Z 17

**Rods**

Cosmos.....Z 18-23  
 Great White™.....Z 24-27  
 Saltfisher.....Z 28-31  
 Surf rods.....Z 32-33  
 Predator rods.....Z 34-35  
 Carp- and Predator rods.....Z 36-37  
 Allround Tele.....Z 38-39  
 Match- und Feeder rods.....Z 40-41  
 Allround rods.....Z 42-43  
 Rod rings.....Z 44-45  
 Combos.....Z 46-48

**Sets**

Sets.....Z 48-53

**Line**

Trophy Line, OMX Braid.....Z 54-58  
 Wire Leaders.....Z 59-60

**Hooks/Rigs**

Trophy Hooks to Nylon.....Z 60-64  
 Sea Fishing Accessories.....Z 64-79  
 Special Leads.....Z 80-81  
 Boat.....Z 82-83  
 Pirk.....Z 84-87  
 Boat Rigs.....Z 88-90  
 Squid Lures.....Z 91-92  
 Spoons.....Z 92-95  
 Spinner.....Z 96-99  
 Plugs.....Z 99-101  
 Spinnersets Assortments.....Z 102-105

**Floats**

Floats.....Z 106-114  
 Ready made Rigs.....Z 115-116

**Luggage/Boxes/Chairs**

Plastic Boxes.....Z 117-118  
 Buckets.....Z 119-123  
 Chairs.....Z 124-126  
 Tents, Umbrellas.....Z 127-130  
 Bags and Holdalls.....Z 131-139

**Accessories**

Landing/Keep Nets.....Z 140-143  
 Swivels.....Z 144-148  
 Lead Weights.....Z 149-153  
 Leadfree Articles.....Z 154  
 Feeders.....Z 155  
 Accessories.....Z 156  
 Bite Alarms.....Z 156-157  
 Knives & Pliers.....Z 158-159  
 Scales.....Z 159-160  
 Disgorgers.....Z 160  
 Boilie Needle.....Z 160-161  
 Bite Alarms.....Z 162-163  
 Accessories.....Z 164  
 Head-Lamps.....Z 165-167  
 Rod Rests.....Z 168-170  
 Clothing.....Z 171-174  
 Smoking.....Z 175  
 Accessories, Promotion.....Z 176-177  
 Shopsystem.....Z 178

Representatives.....Z 180



**Avalanche FD**

This reel series has strong genetic links with absolute top class equipment. The ultra-soft gear action is sure to impress many an angler. The white and gold design was particularly well received in pre-production tests and is in line with modern trends. Another technical highlight is without doubt the good waterproofing of this reel. No water will enter the housing even if the reel is held beneath the surface for several minutes.

**Standard Technical Equipment:**

- CarbonGraphite rotor
- Graphite body
- Finely adjustable front drag
- Folding aluminium handle
- Anti-twist line roller
- Thick bail arm for optimal balance
- Powerful gears
- Aluminium Long Stroke™ spool
- Spare spool
- S-curve line distribution
- Continuous anti-reverse



Code	Model	m / mm	Gear Ratio	Retrieve	BB	Drag F.	Weight
0337 015	615	150 / 0,23	5,2:1	65 cm	6	2,3 kg / 5 lbs	195 g
0337 020	620	180 / 0,23	5,2:1	70 cm	6	3,6 kg / 8 lbs	230 g
0337 030	630	180 / 0,26	5,2:1	75 cm	6	3,6 kg / 8 lbs	248 g
0337 040	640	170 / 0,31	5,2:1	81 cm	6	5,9 kg / 13 lbs	300 g
0337 050	650	190 / 0,33	5,2:1	87 cm	6	5,9 kg / 13 lbs	315 g
0337 070	670	180 / 0,40	4,9:1	96 cm	6	8,6 kg / 19 lbs	390 g

Spare Spool	Model	Material
0989 122	Sp. Spool Avalanche FD 615	Alu
0989 123	Sp. Spool Avalanche FD 620	Alu
0989 124	Sp. Spool Avalanche FD 630	Alu
0989 125	Sp. Spool Avalanche FD 640	Alu
0989 126	Sp. Spool Avalanche FD 650	Alu
0989 127	Sp. Spool Avalanche FD 670	Alu





### Trophy Carver FD

At last, there is another Zebco Trophy high-end reel range with front drag. Spinning anglers in particular will appreciate the large multi-disc drag system in the spool, which runs incredibly smoothly and remains cool and controlled even in critical fight situations. Our engineers have used only the finest components in constructing the reels, which have high-quality fittings across the range.

#### Standard Technical Equipment:

- Electronically balanced lightweight rotor (LWR)
- Finely adjustable front drag
- Folding aluminium handle
- Non-twist line roller
- Aluminium Long Stroke™ spool
- ABS Nylon spare spool
- S-curve line distribution
- Continuous anti-reverse



Code	Model	m / mm	Gear Ratio	Retrieve	BB	Drag F.	Weight
0318 020	720	135 / 0,20	5,1:1	55 cm	7	2,5 kg / 5,5 lbs	246 g
0318 030	730	220 / 0,23	5,1:1	60 cm	7	5,0 kg / 11 lbs	287 g
0318 040	740	240 / 0,23	5,1:1	65 cm	7	5,0 kg / 11 lbs	302 g

Spare Spool	Model	Material
0989 020	Sp.Spool Trophy Carver FD720	Alu
0989 021	Sp.Spool Trophy Carver FD730	Alu
0989 022	Sp.Spool Trophy Carver FD740	Alu



### Great White™

Affordable yet superlative sea reel with the versatility to cover all major types of angling. Finished with indestructible nylon housing and metal components for optimum power. We are confident that this new model will catch on as a best seller for saltwater fishing in Europe.



Code	Model	m / mm	Gear Ratio	Retrieve	BB	Drag F.	Weight
0343 040	440	180 / 0,35	4,8:1	72 cm	4	6,3 kg / 14 lbs	368 g
0343 050	450	200 / 0,35	4,8:1	81 cm	4	8,2 kg / 18 lbs	375 g
0343 060	460	285 / 0,35	4,8:1	92 cm	4	8,2 kg / 18 lbs	386 g

#### Standard Technical Equipment:

- Balanced rotor, producing silky smooth action
- Graphite body
- Finely adjustable large-surface front drag
- CNC stainless steel handle
- Anti-twist line roller
- Thick bail arm for optimal balance
- Powerful gears
- Aluminium spool
- Spare spool
- S-curve line distribution
- Continuous anti-reverse

Spare Spool	Model
0989 138	Sp.Spool Great White™ 440
0989 132	Sp.Spool Great White™ 450
0989 133	Sp.Spool Great White™ 460



### Cosmos MSG

Very attractive front-drag reel with aluminium spool. The model has an extremely smooth gear action for its price segment. With reliable, jolt-free front drag. With visuals complementing the Cosmos rod series.

#### Standard Technical Equipment:

- CarbonGraphite rotor
- Graphite body
- Finely adjustable front drag
- Powerful gears
- Aluminium Long Stroke™ spool
- Spare spool
- S-curve line distribution



Code	Model	m / mm	Gear Ratio	Retrieve	BB	Drag F.	Weight
0360 020	520	175 / 0,20	5,5:1	75 cm	5	5 kg / 11 lbs	278 g
0360 030	530	230 / 0,20	5,5:1	80 cm	5	5 kg / 11 lbs	283 g
0360 040	540	160 / 0,35	5,5:1	85 cm	5	6 kg / 13 lbs	303 g
0360 050	550	190 / 0,35	5,5:1	89 cm	5	6 kg / 13 lbs	313 g

Spare Spool	Model
0989 134	Sp.Spool Cosmos 520 MSG/120 FD
0989 135	Sp.Spool Cosmos 530 MSG/130 FD
0989 136	Sp.Spool Cosmos 540 MSG/140 FD
0989 137	Sp.Spool Cosmos 550 MSG/150 FD

### Cosmos FD

Very attractive front-drag reel with nylon spool. For the price-conscious angler who does not want to sacrifice a smooth gear action. With jolt-free front drag. With visuals complementing the Cosmos rod series.

#### Standard Technical Equipment:

- CarbonGraphite rotor
- Graphite body
- Front drag
- Powerful gears
- Chrome plated ABS Nylon spool
- Spare spool
- S-curve line distribution



Code	Model	m / mm	Gear Ratio	Retrieve	BB	Drag F.	Weight
0361 020	120	175 / 0,20	5,5:1	75 cm	1	5 kg / 11 lbs	227 g
0361 030	130	230 / 0,20	5,5:1	80 cm	1	5 kg / 11 lbs	228 g
0361 040	140	160 / 0,35	5,5:1	85 cm	1	6 kg / 13 lbs	253 g
0361 050	150	190 / 0,35	5,5:1	89 cm	1	6 kg / 13 lbs	255 g

Spare Spool	Model
0989 134	Sp.Spool Cosmos 520 MSG/120 FD
0989 135	Sp.Spool Cosmos 530 MSG/130 FD
0989 136	Sp.Spool Cosmos 540 MSG/140 FD
0989 137	Sp.Spool Cosmos 550 MSG/150 FD

### S-RAY BR

Run control reels remain highly popular. Whether for carp or pike sport, eel or feeder fishing, the run control function provides compelling options for a range of fishing techniques. In this highly modern range, Zebco presents a flagship in the affordable segment, whose equipment stands up to comparison with its own high-end models.

#### Standard Technical Equipment:

- Finely adjustable front drag
- Finely adjustable run control system
- Folding aluminium handle
- Anti-twist line roller
- Thick bail arm for optimal balance
- ABS Nylon spare spool
- S-curve line distribution
- Continuous anti-reverse



Code	Model	m / mm	Gear Ratio	Retrieve	BB	Drag F.	Weight
0297 040	40	210 / 0,25	5.1:1	68 cm	6	5,4 kg / 12 lbs	351 g
0297 050	50	230 / 0,30	4.9:1	74 cm	6	5,9 kg / 13 lbs	457 g
0297 060	60	190 / 0,45	4.9:1	88 cm	6	6,4 kg / 14 lbs	555 g



### S-RAY BRN

Run control reel specially designed for novices and occasional anglers who want maximum fishing pleasure for a minimum investment. No compromises have been made on the essential features of a quality fishing reel. The reel has three ball bearings and also impresses with the smoothness of its run control function. Beginner carp anglers will particularly appreciate the fantastic price-performance ratio and contemporary visuals.

#### Standard Technical Equipment:

- CarbonGraphite rotor
- Finely adjustable front drag
- Finely adjustable run control system
- Anti-twist line roller
- Spare spool
- Continuous anti-reverse



Code	Model	m / mm	Gear Ratio	Retrieve	BB	Drag F.	Weight
0298 030	30	250 / 0,20	5.1:1	62 cm	3	4,5 kg / 10 lbs	335 g
0298 040	40	210 / 0,25	5.1:1	68 cm	3	5,4 kg / 12 lbs	348 g
0298 050	50	230 / 0,30	4.9:1	74 cm	3	5,4 kg / 12 lbs	450 g
0298 060	60	190 / 0,45	4.9:1	88 cm	3	6,4 kg / 14 lbs	551 g



Spare Spool	Model	Material
0987 409	Sp. Spool S-RAY 40	Alu
0987 410	Sp. Spool S-RAY 50	Alu
0987 411	Sp. Spool S-RAY 60	Alu

Spare Spool	Model	Material
0987 408	Sp. Spool S-RAY 30	Alu
0987 409	Sp. Spool S-RAY 40	Alu
0987 410	Sp. Spool S-RAY 50	Alu
0987 411	Sp. Spool S-RAY 60	Alu





**Zcast FD**

A fantastic reel series in the Zebco range. The reels impress with their pleasant gear action and slender design. With 5 ball bearings and continuous anti-reverse, the reel has unbelievable high-class features for the price segment.



Code	Model	m / mm	Gear Ratio	Retrieve	BB	Drag F.	Weight
0316 020	520	240 / 0,18	5,1:1	69 cm	5	2,5 kg / 5,5 lbs	270 g
0316 030	530	245 / 0,25	5,1:1	72 cm	5	5,0 kg / 11 lbs	289 g
0316 040	540	195 / 0,30	5,1:1	78 cm	5	5,0 kg / 11 lbs	298 g
0316 050	550	195 / 0,35	5,1:1	84 cm	5	7,5 kg / 16,5 lbs	318 g

**Standard Technical Equipment:**

- Front drag
- Folding handle with push-button release
- Non-twist line roller
- Thick bail arm for optimal balance
- Aluminium spool
- Spare spool
- Continuous anti-reverse

Spare Spool	Model	Material
0989 118	Sp. Spool Zcast FD 520	Nylon
0989 119	Sp. Spool Zcast FD 530	Nylon
0989 120	Sp. Spool Zcast FD 540	Nylon
0989 121	Sp. Spool Zcast FD 550	Nylon



**Saltfisher FD**

Affordable sea fishing reel in four sizes covering all major types of angling. Finished with indestructible nylon housing and metal components for optimum power.



Code	Model	m / mm	Gear Ratio	Retrieve	BB	Drag F.	Weight
0375 140	140	175 / 0,30	5,2:1	87 cm	1	5,5 kg / 12 lbs	240 g
0375 150	150	195 / 0,35	5,2:1	92 cm	1	6,5 kg / 14 lbs	330 g
0375 160	160	155 / 0,45	5,2:1	98 cm	1	6,5 kg / 14 lbs	340 g
0375 180	180	395 / 0,40	5,2:1	94 cm	1	7,5 kg / 16,5 lbs	490 g

**Standard Technical Equipment:**

- Robust nylon housing
- Front drag
- Chrome plated ABS Nylon spool
- Spare spool
- S-curve line distribution
- Multistop anti-reverse clutch

Spare Spool	Model	Material
0989 201	Sp. Spool Saltfisher 140 FD	Nylon
0989 202	Sp. Spool Saltfisher 150 FD	Nylon
0989 203	Sp. Spool Saltfisher 160 FD	Nylon
0989 204	Sp. Spool Saltfisher 170 FD	Nylon





**NEW**



**Atac II**

Our prices are tumbling! Anglers can expect an excellent price-performance ratio from this Zebco reel series. Available in the single ball bearing basic version for legering and spinning, for which the reel simply has to function.

**Standard Technical Equipment:**

- CarbonGraphite rotor
- Graphite body
- Front drag
- Spare spool
- S-curve line distribution
- Multistop anti-reverse clutch



Code	Model	m / mm	Gear Ratio	Retrieve	BB	Drag F.	Weight
0367 120	120 FD	230 / 0,25	5,2:1	77 cm	1	4 kg / 8,8 lbs	220 g
0367 130	130 FD	150 / 0,35	5,2:1	80 cm	1	5,5 kg / 12,1 lbs	230 g
0367 140	140 FD	175 / 0,35	5,2:1	87 cm	1	5,5 kg / 12,1 lbs	240 g

**Stinger**

A veritable bargain reel. Supplied ready to fish and filled with suitable line. A bargain for all novices and occasional anglers. Simply buy and go fishing!

**Standard Technical Equipment:**

- Front drag
- ABS Nylon spool
- Spare spool
- Multistop anti-reverse clutch



Code	Model	m / mm	Gear Ratio	Retrieve	BB	Drag F.	Weight
0340 020	20	170 / 0,22	5,2:1	67 cm	1	3,6 kg / 8 lbs	238 g
0340 030	30	230 / 0,22	5,2:1	70 cm	1	4,5 kg / 10 lbs	252 g
0340 040	40	160 / 0,26	4,3:1	61 cm	1	5,4 kg / 12 lbs	278 g
0340 050	50	180 / 0,26	4,3:1	66 cm	1	5,4 kg / 12 lbs	285 g
0340 060	60	190 / 0,30	5,0:1	84 cm	1	9,1 kg / 20 lbs	355 g
0340 080	80	210 / 0,35	5,0:1	91 cm	1	9,1 kg / 20 lbs	396 g

**Cool X RD**

A great value for money reel for the price conscious angler, who still insists on the fundamental components in equipment. One ball bearing in the most important point of the rotor head ensures a smooth oscillation. The reel contains many features and benefits associated with higher priced reels.

**Standard Technical Equipment:**

- Balanced rotor, producing silky smooth action
- Finely adjustable rear drag
- Ergonomic handle knob
- Non-twist line roller
- ABS Nylon spool
- Spare spool
- S-curve line distribution
- Continuous anti-reverse



Code	Model	m / mm	Gear Ratio	Retrieve	BB	Drag F.	Weight
0310 020	320	200 / 0,20	5,2:1	73 cm	3	4,5 kg / 10 lbs	283 g
0310 030	330	330 / 0,20	5,2:1	73 cm	3	4,5 kg / 10 lbs	285 g
0310 040	340	260 / 0,30	4,8:1	75 cm	3	5,4 kg / 12 lbs	385 g
0310 050	350	220 / 0,35	4,8:1	75 cm	3	5,4 kg / 12 lbs	387 g

Spare Spool	Model	Material
0989 108	Sp.Spool Cool X RD320	Nylon
0989 109	Sp.Spool Cool X RD330	Nylon
0989 110	Sp.Spool Cool X RD340	Nylon
0989 111	Sp.Spool Cool X RD350	Nylon





### Cool CS RD

Affordable reels offering essential features but without the frills. With 1 ball bearing for a smooth gear action. The large drag also means the reel is perfect for hard fighting fish.

#### Standard Technical Equipment:

- Robust nylon housing
- Rear-drag system
- S-curve line distribution
- Multistop anti-reverse clutch



Delivered in clam pack.



Code	Model	m / mm	Gear Ratio	Retrieve	BB	Drag F.	Weight
0237 030	130	135 / 0,28	5.2:1	65 cm	1	3,2 kg / 7 lbs	230 g
0237 050	150	170 / 0,40	4.9:1	72 cm	1	4,1 kg / 9 lbs	330 g

Spare Spool	Model
0989 051	Sp.Spool Cool CS RD130
0989 052	Sp.Spool Cool CS RD150

### Cool CS FD

Affordable reels offering essential features but without the frills. With 1 ball bearing for a smooth gear action. The large drag also means the reel is perfect for hard fighting fish.

#### Standard Technical Equipment:

- Robust nylon housing
- Powerful multi-disc front drag system
- S-curve line distribution
- Multistop anti-reverse clutch



Delivered in clam pack.



Code	Model	m / mm	Gear Ratio	Retrieve	BB	Drag F.	Weight
0238 030	130	135 / 0,28	5.2:1	65 cm	1	4,5 kg / 10 lbs	220 g
0238 050	150	150 / 0,40	5.2:1	72 cm	1	4,5 kg / 10 lbs	250 g

Spare Spool	Model
0989 053	Sp.Spool Cool CS FD130
0989 054	Sp.Spool Cool CS FD150

### Saltfisher Surf

Value-for-money sea reel with large line capacity. Ideal for surf or boat fishing. With continuous anti-reverse.

#### Standard Technical Equipment:

- Oversized multi-stack drag system
- Anti-twist line roller
- Powerful gears
- Aluminium Long Stroke™ spool
- S-curve line distribution
- Continuous anti-reverse



Code	Model	m / mm	Gear Ratio	Retrieve	BB	Drag F.	Weight
0376 370	370	395 / 0,40	4,1:1	88 cm	3	7,5 kg / 16,5 lbs	640 g
0376 380	380	485 / 0,40	4,1:1	94 cm	3	7,5 kg / 16,5 lbs	660 g

Spare Spool	Model
0989 205	Sp.Spool Saltfisher Surf 370
0989 206	Sp.Spool Saltfisher Surf 380



### Cool Red Surf FD

Affordable reel for sea anglers with a wide range of uses. Particularly suited to surf angling, which requires long casting distances, thanks to its high line capacity.

#### Standard Technical Equipment:

- Front drag
- Quick-fold handle
- Large line roller with anti-twist system
- Two-speed oscillation system
- Multistop anti-reverse clutch



Code	Model	m / mm	Gear Ratio	Retrieve	BB	Drag F.	Weight
0280 065	165	120 / 0,45	5.6:1	83 cm	1	5,0 kg / 11 lbs	364 g

Spare Spool	Model	Material
0989 095	Sp.Spool Cool Red Surf FD165	Nylon



### Patriot FD

Incredible value reel for sea anglers, offering the most diverse range of tasks. 7 ball bearings and an aluminium long cast spool, all at a very attractive price.

#### Standard Technical Equipment:

- Balanced rotor, producing silky smooth action
- Finely adjustable front drag
- Anti-twist line roller
- Aluminium Long Stroke™ spool
- Spare spool
- Two-speed oscillation system
- Continuous anti-reverse



Code	Model	m / mm	Gear Ratio	Retrieve	BB	Drag F.	Weight
0302 065	765	430 / 0,30	5.6:1	112 cm	7	7,3 kg / 16 lbs	500 g

Spare Spool	Model	Material
0989 099	Sp.Spool Patriot FD765	Alu

### Saltfisher Trolling

Attractive sea fishing multiplier reel with line guide and robust star-wheel drag. The line guide makes it easy for inexperienced anglers to handle the reel and to enjoy the benefits of the particularly robust design. And all ready to go: Filled with 200 m/0.35 mm quality braid – scarcely believable at such a low price.

#### Standard Technical Equipment:

- Robust nylon housing
- Die-cast aluminium handle
- Powerful gears
- Multistop anti-reverse clutch
- Highly audible clicker



Code	Model	m / mm	Gear Ratio	Retrieve	BB	Drag F.	Weight
0379 030	LF30	420 / 0,40	4,2:1	70 cm	2	14,00 kg / 31,00 lbs	490 g

Spare Spool	Model	Material
0989 170	Sp.Spool Saltfisher Trolling LF30	Alu



Loaded with braided line!

### Cool Lite FD

Small, but really effective little fixed spool reel for light spinning, coarse fishing and legering. Fitted with a large line roller.

#### Standard Technical Equipment:

- Compact housing design
- Finely adjustable front drag
- Large line guide
- Aluminium spool



Code	Model	m / mm	Gear Ratio	Retrieve	BB	Drag F.	Weight
0120 005	305	125 / 0,25	5.2:1	51 cm	3	3,2 kg / 7 lbs	141 g

### Cool Trolling LH

Simple left-handed multiplier reel with counter. Once you have discovered a good catching depth, you can find it again time after time.

#### Standard Technical Equipment:

- Oversized multi-stack drag system
- Powerful gears
- Rapid line retrieval
- Continuous anti-reverse



Code	Model	m / mm	Gear Ratio	Retrieve	BB	Drag F.	Weight
0338 040	440	320 / 0,55	4,6:1	117 cm	4	12,2 kg / 27 lbs	670 g

Spare Spool	Model	Material
0989 129	Sp. Spool Cool Trolling 440	Alu







NEW



### Great White™ Trolling

Simple yet robust multipliers for sea fishing. Unprecedented price-performance ratio. Ideal for both trolling and natural bait fishing. Available in two sizes in right-handed versions. The perfect partner for our Great White™ rod series. Impresses with its robust gear components, aluminium spool and continuous anti-reverse.

#### Standard Technical Equipment:

- Robust nylon housing
- Oversized multi-stack drag system
- Die-cast aluminium handle
- Powerful gears
- Continuous anti-reverse



Code	Model	m / mm	Gear Ratio	Retrieve	BB	Drag F.	Weight
0380 020	RH20	260 / 0,35	5,6:1	72 cm	3	10 kg / 20,5 lbs	420 g
0380 030	RH30	420 / 0,40	4,2:1	67 cm	3	12 kg / 24,5 lbs	510 g

Spare Spool	Model
0989 176	Sp.Spool Great White Trolling RH20
0989 175	Sp.Spool Great White Trolling RH 30



NEW



### Great White™ Boat

Simple yet robust multiplier for sea fishing. Unprecedented price-performance ratio. Ideal for both trolling and natural bait fishing. The left-handed design is appreciated by many anglers who only use a multiplier occasionally and are accustomed to using their left hand with fixed-spool reels. With line counter.

#### Standard Technical Equipment:

- Robust nylon housing
- Oversized multi-stack drag system
- Powerful gears
- Aluminium spool
- Continuous anti-reverse



Code	Model	m / mm	Gear Ratio	Retrieve	BB	Drag F.	Weight
0385 030	LH30	420 / 0,40	3,8:1	62 cm	4	16 kg / 34,5 lbs	570 g

Spare Spool	Model	Material
0989 180	Sp.Spool Great White Boat LH30	Alu





### Cosmos Surf

This two-piece surf rod will ensure you always come out on top in the surf. The ideal partner for long-range casting and powerful fighting. Carbon rods at a price that scarcely seems possible!

Code	Model	Length	Sections	C.W.	Tr.-Length	Weight
13009 360	Cosmos Surf	3,60 m	2	100 - 200 g	1,87 m	624 g
13009 420	Cosmos Surf	4,20 m	3	200 g	1,47 m	728 g
13009 450	Cosmos Surf	4,50 m	3	200 g	1,57 m	832 g



### Cosmos Spin

An extremely sensitive yet tough rod for lure fishing. The blank has been finished using the most up-to-date techniques to enable bite recognition right down to the rod handle.

Code	Model	Length	Sections	C.W.	Tr.-Length	Weight
14129 220	Cosmos Spin	2,20 m	2	20 g	1,16 m	177 g
14129 245	Cosmos Spin	2,45 m	2	20 g	1,27 m	188 g
14129 270	Cosmos Spin	2,70 m	2	20 g	1,41 m	205 g
14130 220	Cosmos Spin	2,20 m	2	40 g	1,15 m	181 g
14130 245	Cosmos Spin	2,45 m	2	40 g	1,29 m	203 g
14130 270	Cosmos Spin	2,70 m	2	40 g	1,41 m	245 g
14131 220	Cosmos Spin	2,20 m	2	60 g	1,17 m	207 g
14131 245	Cosmos Spin	2,45 m	2	60 g	1,29 m	253 g
14131 270	Cosmos Spin	2,70 m	2	60 g	1,40 m	275 g



### Cosmos Droppy

Sensitive spinning rod for dropshot angling. Ultra-fast-reacting blank that guarantees pleasure when lure fishing. With stylish, high-quality equipment. Carbon rods at a price that scarcely seems possible!

Code	Model	Length	Sections	C.W.	Tr.-Length	Weight
14132 210	Cosmos Droppy	2,10 m	2	30 g	1,09 m	154 g



### Cosmos Sea Jig

Light sea rod with average casting weight. Suitable for light plaice and cod angling. The robust blanks will also withstand the occasional knocks that inevitably happen when boat fishing.

Code	Model	Length	Sections	C.W.	Tr.-Length	Weight
13010 240	Cosmos Sea Jig	2,40 m	2	50 - 130 g	1,29 m	235 g
13010 270	Cosmos Sea Jig	2,70 m	2	50 - 130 g	1,40 m	250 g
13010 300	Cosmos Sea Jig	3,00 m	2	50 - 130 g	1,56 m	296 g



### Cosmos Pilk

All-round pirking rod series for a variety of uses in moderate sea fishing. Equipped with a powerful blank to tame the most powerful predators in any situation. Carbon rods at a price that scarcely seems possible!

Code	Model	Length	Sections	C.W.	Tr.-Length	Weight
13011 240	Cosmos Pilk	2,40 m	2	180 g	1,27 m	264 g
13011 270	Cosmos Pilk	2,70 m	2	180 g	1,40 m	308 g





### Cosmos Tele Surf 150

Moderate telescopic surf rod based on the Mediterranean design. Easy to transport yet strong on the cast. With sufficient backbone to reel in fish rapidly through the surf. Carbon rods at a price that scarcely seems possible!

Code	Model	Length	Sections	C.W.	Tr.-Length	Weight
13803 420	Cosmos Tele Surf 150	4,20 m	4	120 - 150 g	1,49 m	450 g



### Cosmos Tele Track

A mid-range telescopic rod in the four most popular lengths. The compact design allows the rod to be stored away easily and set up quickly whether on local waters or on holiday.

Code	Model	Length	Sections	C.W.	Tr.-Length	Weight
17000 180	Cosmos Tele Track	1,80 m	6	10 - 35 g	0,55 m	144 g
17000 210	Cosmos Tele Track	2,10 m	6	10 - 35 g	0,59 m	158 g
17000 240	Cosmos Tele Track	2,40 m	7	10 - 35 g	0,61 m	210 g
17000 270	Cosmos Tele Track	2,70 m	8	10 - 35 g	0,59 m	218 g



### Cosmos Tele

A mid-range telescopic rod in the four most popular lengths. The compact design allows the rod to be stored away easily and set up quickly whether on local waters or on holiday.

Code	Model	Length	Sections	C.W.	Tr.-Length	Weight
17001 240	Cosmos Tele	2,40 m	6	15 - 45 g	0,63 m	214 g
17001 270	Cosmos Tele	2,70 m	6	15 - 45 g	0,61 m	217 g
17001 300	Cosmos Tele	3,00 m	7	15 - 45 g	0,62 m	225 g
17002 240	Cosmos Tele	2,40 m	6	20 - 70 g	0,61 m	216 g
17002 270	Cosmos Tele	2,70 m	6	20 - 70 g	0,61 m	220 g
17002 300	Cosmos Tele	3,00 m	7	20 - 70 g	0,62 m	231 g



### Cosmos Carp

Classic carp rod for beginners and occasional carp hunters. The through action forgives practically any mistakes in a fight, making the rod a foolproof partner. Carbon rods at a price that scarcely seems possible!

Code	Model	Length	Sections	Tr.-Length	Testcurve	Weight
16002 360	Cosmos Carp	3,60 m	2	1,86 m	2,75 lbs	350 g
16002 361	Cosmos Carp	3,60 m	2	1,86 m	3,00 lbs	385 g
16002 362	Cosmos Carp	3,60 m	2	1,86 m	3,50 lbs	393 g
16002 390	Cosmos Carp	3,90 m	2	2,00 m	3,00 lbs	410 g
16002 391	Cosmos Carp	3,90 m	2	2,00 m	3,50 lbs	417 g





### Cosmos Pike

Powerful pike spinning rod intended for fishing with spoons, soft lures or hard baits. The carbon blank has sufficient casting power to reach even remote predators and the backbone to quickly break their resistance in a fight.

Code	Model	Length	Sections	C.W.	Tr.-Length	Weight
14133 270	Cosmos Pike	2,70 m	2	135 g	1,41 m	307 g

### Cosmos Tele

By popular request, we have introduced a telescopic deadbaiting rod into the Cosmos rod series. With an incredible range and fantastic action and power in abundance from the carbon blank.

Code	Model	Length	Sections	C.W.	Tr.-Length	Weight
17800 650	Cosmos Tele	6,50 m	7	150 g	1,19 m	650 g
17800 750	Cosmos Tele	7,50 m	8	150 g	1,20 m	840 g

### Cosmos Tele Float

Telescopic float rod series for a range of uses in light to moderate coarse angling. The slender and light blanks make angling a pure pleasure. Carbon rods at a price that scarcely seems possible!

Code	Model	Length	Sections	C.W.	Tr.-Length	Weight
12800 400	Cosmos Tele Float	4,00 m	4	35 g	1,21 m	361 g
12800 500	Cosmos Tele Float	5,00 m	5	35 g	1,23 m	388 g
12800 600	Cosmos Tele Float	6,00 m	6	35 g	1,25 m	490 g

### Cosmos CF Tele Pole

A real price-crusher in the Bolo rod segment. Beginners in particular will love the phenomenal performance-for-price.

Code	Model	Length	Sections	Tr.-Length	Weight
10004 400	Cosmos CF Tele Pole	4,00 m	4	1,20 m	270 g
10004 500	Cosmos CF Tele Pole	5,00 m	5	1,20 m	390 g
10004 600	Cosmos CF Tele Pole	6,00 m	6	1,20 m	570 g
10004 700	Cosmos CF Tele Pole	7,00 m	7	1,20 m	750 g





NEW

### Great White™ Boat Stand Up

Great White rods are indestructible sea fishing rods made from a unique mix of fibreglass and epoxy. Materials that are far from being on the scrap heap! They continue to prove their benefits time after time. The Standup rod is the one-piece multi-talent for fishing from the boat, when lifting power is of the essence during a fight without requiring a particularly long rod.

Code	Model	Length	Sections	C.W.	Tr-Length	Weight
13012 170	Great White™ Boat Stand Up	1,70 m	1	12 lbs	1,70 m	324 g
13012 171	Great White™ Boat Stand Up	1,70 m	1	20 lbs	1,70 m	370 g
13012 172	Great White™ Boat Stand Up	1,70 m	1	30 lbs	1,70 m	380 g

### Great White™ Boat Outshore H

Great White rods are indestructible sea fishing rods made from a unique mix of fibreglass and epoxy. Materials that are far from being on the scrap heap! They continue to prove their benefits time after time. The Outshore H is a powerful natural bait rod with a gimbal end cap. Sea predators throughout Europe beware.

Code	Model	Length	Sections	C.W.	Tr-Length	Weight
13013 180	Great White™ Boat Outshore H	1,80 m	1	400 - 600 g	1,80 m	390 g
13013 220	Great White™ Boat Outshore H	2,20 m	2	400 - 600 g	1,15 m	480 g

### Great White™ Boat Outshore MH

Great White rods are indestructible sea fishing rods made from a unique mix of fibreglass and epoxy. Materials that are far from being on the scrap heap! They continue to prove their benefits time after time. The Outshore MH is a moderate natural bait rod. Designed for a wide range of uses.

Code	Model	Length	Sections	C.W.	Tr-Length	Weight
13014 180	Great White™ Boat Outshore MH	1,80 m	2	100 - 350 g	0,96 m	386 g
13014 220	Great White™ Boat Outshore MH	2,20 m	2	100 - 350 g	1,15 m	450 g
13014 240	Great White™ Boat Outshore MH	2,40 m	2	100 - 350 g	1,27 m	508 g

### Great White™ Sensi Boat

The 2.35 m boat rods in this series are ideal for use on shelf waters around Norway and Iceland as well as being reliable partners for boat anglers on the North Sea and Baltic Sea, with the sensitive tips offering fine bite indication.

Code	Model	Length	Sections	C.W.	Tr-Length	Weight
13023 235	Great White Sensi Boat	2,35 m	2	6 - 12 lbs	1,22 m	251 g
13023 236	Great White Sensi Boat	2,35 m	2	12 - 20 lbs	1,22 m	252 g
13023 237	Great White Sensi Boat	2,35 m	2	20 - 30 lbs	1,22 m	265 g







NEW



NEW

### Great White™ Hard Lure

Great White rods are indestructible sea fishing rods made from a unique mix of fibreglass and epoxy. Materials that are far from being on the scrap heap! They continue to prove their benefits time after time. The Hard Lure is a heavy-duty pirking rod, e.g. for use in Norway or on the Yellow Reef.

Code	Model	Length	Sections	C.W.	Tr.-Length	Weight
13015 180	Great White™ Hard Lure	1,80 m	2	80 - 300 g	0,96 m	267 g
13015 220	Great White™ Hard Lure	2,20 m	2	80 - 300 g	1,15 m	368 g
13015 240	Great White™ Hard Lure	2,40 m	2	80 - 300 g	1,27 m	423 g
13015 270	Great White™ Hard Lure	2,70 m	2	80 - 300 g	1,40 m	584 g

### Great White™ Light Lure

Great White rods are indestructible sea fishing rods made from a unique mix of fibreglass and epoxy. Materials that are far from being on the scrap heap! They continue to prove their benefits time after time. The Light Lure is a light to moderate pirking rod, e.g. for use on the Baltic Sea or in shallower fjord areas of Norway.

Code	Model	Length	Sections	C.W.	Tr.-Length	Weight
13016 220	Great White™ Light Lure	2,20 m	2	30 - 160 g	1,15 m	344 g
13016 240	Great White™ Light Lure	2,40 m	2	30 - 160 g	1,27 m	361 g
13016 270	Great White™ Light Lure	2,70 m	2	30 - 160 g	1,41 m	551 g

### Great White™ Univers

Great White rods are indestructible sea fishing rods made from a unique mix of fibreglass and epoxy. Materials that are far from being on the scrap heap! They continue to prove their benefits time after time. The Univers is a powerful sea rod with mixed rings for use with both multipliers and fixed-spool reels. Cod, ling and halibut are ideal opponents to target with this rod.

Code	Model	Length	Sections	C.W.	Tr.-Length	Weight
13017 220	Great White™ Univers	2,20 m	2	300 g	1,15 m	385 g
13017 240	Great White™ Univers	2,40 m	2	300 g	1,27 m	453 g
13017 270	Great White™ Univers	2,70 m	2	300 g	1,41 m	623 g

### Great White™ Kayak

These kayak rods are based upon a slender, well-balanced blank. To keep the rods slim and easy to handle, we have combined the epoxy material of the Great White series with carbon. The end of the handle has a metal ring for attaching a securing rope. The length of 2 m also allows larger fish to be tamed in a fight and safely steered around the bow or stern.

Code	Model	Length	Sections	C.W.	Tr.-Length	Weight
13021 012	Great White Kayak	2,00 m	2	5 - 40 g / 6 - 12 lbs	1,35 m	201 g
13021 020	Great White Kayak	2,00 m	2	20 - 60 g / 10 - 20 lbs	1,35 m	204 g

### Great White™ Tele Pilk

Great White rods are indestructible sea fishing rods made from a unique mix of materials comprising epoxy and, in this case, carbon. This is what makes the rod so valuable yet light and slender. The Tele Pilk rods are primarily designed for water depths from 15 m, whether on the Baltic Sea, North Sea or in the far north – the firm blanks can stand up even to large opponents while the short transport lengths make them ideal travel companions.

Code	Model	Length	Sections	C.W.	Tr.-Length	Weight
13022 180	Great White Tele Pilk	1,80 m	5	50 - 200 g	0,66 m	189 g
13022 210	Great White Tele Pilk	2,10 m	5	50 - 200 g	0,66 m	202 g
13022 240	Great White Tele Pilk	2,40 m	6	50 - 200 g	0,68 m	237 g
13022 270	Great White Tele Pilk	2,70 m	6	50 - 200 g	0,68 m	251 g





### Saltfisher Surf

The name of this rod series says it all. The sea is where these modern sea rods made from flexible and durable fibreglass braid are at home. These surf rods load up very quickly and achieve outstanding casting distances even with a normal level of effort.

Code	Model	Length	Sections	C.W.	Tr.-Length	Weight
13100 390	Saltfisher Surf	3,90 m	3	100 - 200 g	1,36 m	610 g
13100 420	Saltfisher Surf	4,20 m	3	100 - 200 g	1,46 m	690 g
13100 450	Saltfisher Surf	4,50 m	3	100 - 200 g	1,56 m	770 g

### Saltfisher Tele Surf

The name of this rod series says it all. The sea is where these modern sea rods made from flexible and durable fibreglass braid are at home. These surf rods load up very quickly and achieve outstanding casting distances even with a normal level of effort.

Code	Model	Length	Sections	C.W.	Tr.-Length	Weight
13101 420	Saltfisher Tele Surf	4,20 m	1+1	100 - 200 g	1,42 m	590 g

### Saltfisher Pilk

The name of this rod series says it all. The sea is where these modern sea rods made from flexible and durable fibreglass braid are at home. These rods are designed for light to moderate lure fishing. They set themselves apart with light handling and perfectly refined actions.

Code	Model	Length	Sections	C.W.	Tr.-Length	Weight
13105 140	Saltfisher Pilk	1,40 m	2	60 - 180 g	0,74 m	200 g
13105 165	Saltfisher Pilk	1,65 m	2	60 - 180 g	0,84 m	240 g
13105 180	Saltfisher Pilk	1,80 m	2	60 - 180 g	0,95 m	260 g
13105 210	Saltfisher Pilk	2,10 m	2	60 - 180 g	1,08 m	344 g
13105 240	Saltfisher Pilk	2,40 m	2	60 - 180 g	1,25 m	408 g
13105 270	Saltfisher Pilk	2,70 m	2	60 - 180 g	1,39 m	496 g

### Saltfisher Compact

The name of this rod series says it all. The sea is where these modern sea rods made from flexible and durable fibreglass braid are at home. In this case, the blank is made from fibreglass and is absolutely indestructible. Need we say more?

Code	Model	Length	Sections	C.W.	Tr.-Length	Weight
13106 100	Saltfisher Compact	1,00 m	1	100 - 200 g	1,00 m	192 g
13106 120	Saltfisher Compact	1,20 m	1	100 - 200 g	1,20 m	203 g

### Saltfisher Battle North

The name of this rod series says it all. The sea is where these modern sea rods made from flexible and durable fibreglass braid are at home. Battle by name, battler by nature. This rod series was made for fighting large specimens in northern waters. Whether you are using natural baits or heavy pirkers, you are ready for battle.

Code	Model	Length	Sections	C.W.	Tr.-Length	Weight
13107 180	Saltfisher Battle North	1,80 m	2	350 g	0,95 m	330 g
13107 210	Saltfisher Battle North	2,10 m	2	350 g	1,08 m	400 g
13107 240	Saltfisher Battle North	2,40 m	2	350 g	1,25 m	460 g





NEW

### Saltfisher Tele Boat 80

The name of this rod series says it all. The sea is where these modern sea rods made from flexible and durable fibreglass braid are at home. Tele Boat rods are light boat rods for flatfish sport and use on the Mediterranean.

Code	Model	Length	Sections	C.W.	Tr.-Length	Weight
13109 240	Saltfisher Tele Boat 80	2,40 m	1+1	20 - 100 g	0,80 m	250 g
13109 270	Saltfisher Tele Boat 80	2,70 m	1+1	20 - 100 g	0,85 m	290 g



NEW

### Saltfisher Boat H

The name of this rod series says it all. The sea is where these modern sea rods made from flexible and durable fibreglass braid are at home. The versatile rod series suitable for use from the Baltic Sea to Iceland offers a reliable partner for any coastal waters in Europe.

Code	Model	Length	Sections	C.W.	Tr.-Length	Weight
13110 180	H	1,80 m	2	100 - 250 g	0,95 m	312 g
13110 210	H	2,10 m	2	100 - 250 g	1,08 m	360 g
13110 240	H	2,40 m	2	100 - 250 g	1,25 m	480 g
13110 270	H	2,70 m	2	100 - 250 g	1,39 m	500 g



NEW

### Saltfisher Boat XH

The name of this rod series says it all. The sea is where these modern sea rods made from flexible and durable fibreglass braid are at home. The versatile rod series suitable for use from the Baltic Sea to Iceland offers a reliable partner for any coastal waters in Europe.

Code	Model	Length	Sections	C.W.	Tr.-Length	Weight
13111 210	XH	2,10 m	2	200 - 500 g	1,08 m	352 g
13111 240	XH	2,40 m	2	200 - 500 g	1,25 m	512 g
13111 270	XH	2,70 m	2	200 - 500 g	1,39 m	560 g



NEW

### Saltfisher Light Pilk

The name of this rod series says it all. The sea is where these modern sea rods made from flexible and durable fibreglass braid are at home. These rods are designed for light to moderate lure fishing. They set themselves apart with light handling and perfectly refined actions.

Code	Model	Length	Sections	C.W.	Tr.-Length	Weight
13115 180	Saltfisher Light Pilk	1,80 m	2	30 - 130 g	0,95 m	260 g
13115 210	Saltfisher Light Pilk	2,10 m	2	30 - 130 g	1,08 m	292 g
13115 240	Saltfisher Light Pilk	2,40 m	2	30 - 130 g	1,25 m	372 g
13115 270	Saltfisher Light Pilk	2,70 m	2	30 - 130 g	1,39 m	440 g



NEW

### Saltfisher Tele Pilk

The name of this rod series says it all. The sea is where these modern sea rods made from flexible and durable fibreglass braid are at home. The all-rounder fits easy into any travel baggage.

Code	Model	Length	Sections	C.W.	Tr.-Length	Weight
13153 240	Saltfisher Tele Pilk	2,40 m	4	50 - 180 g	0,70 m	300 g
13153 270	Saltfisher Tele Pilk	2,70 m	5	50 - 180 g	0,81 m	340 g





### Codfather

Excellently equipped pirking rod with ergonomic cork handle. K-Frame rings make casting with thin braided lines child's play, while snapped line due to twisting around the rings is a thing of the past. These rods' sensitive blanks impressed our testers immediately.

Code	Model	Length	Sections	C.W.	Tr.-Length	Weight
13008 220	Codfather	2,20 m	2	60 - 180 g	1,14 m	193 g
13008 245	Codfather	2,45 m	2	60 - 180 g	1,27 m	230 g
13008 280	Codfather	2,80 m	2	60 - 180 g	1,44 m	273 g
13008 305	Codfather	3,05 m	2	60 - 180 g	1,56 m	298 g



### Stormbringer Surf

The ideal blend of high-quality carbon and durable, flexible fiberglass material make the series the ideal all-rounder for surf angling. The blank loads up easily when casting, allowing even occasional anglers to punch out their lead over long distances with effortless ease. The flexible tip sensitively indicates even the slightest bites from flatfish.

Code	Model	Length	Sections	C.W.	Tr.-Length	Weight
13050 390	Stormbringer Surf	3,90 m	3	100 - 200 g	1,38 m	565 g
13050 420	Stormbringer Surf	4,20 m	3	100 - 200 g	1,48 m	585 g
13050 450	Stormbringer Surf	4,50 m	3	100 - 200 g	1,57 m	690 g



### Stormbringer Pier'n Flat

The two-piece IM6 carbon rod with integrated E-Glass tip is specially designed for fishing from jetties or small boats. The blank has sufficient backbone to cast the bait a significant distance while the sensitive bite detection via the fine fiberglass tip clearly indicates any attack on the bait.

Code	Model	Length	Sections	C.W.	Tr.-Length	Weight
13810 360	Stormbringer Pier'n Flat	3,60 m	2	40 - 140 g	1,87 m	387 g



### Cool Red Surf

Made of tough glass fibre, these rods are designed specifically for surf fishing. They have a stiff action and very good casting qualities. The largest guide can be folded for easy transportation.

Code	Model	Length	Sections	C.W.	Tr.-Length	Weight
13801 390	Cool Red Surf	3,90 m	3	100 - 200 g	1,40 m	720 g
13801 420	Cool Red Surf	4,20 m	3	100 - 200 g	1,50 m	810 g
13801 450	Cool Red Surf	4,50 m	3	100 - 200 g	1,60 m	890 g



### Cool Power Red Surf

This two-piece surf rod in indestructible fiberglass material will ensure you always come out on top in the surf. The ideal partner for long-range casting and powerful fighting.

Code	Model	Length	Sections	C.W.	Tr.-Length	Weight
13802 360	Cool Power Red Surf	3,60 m	2	120 - 200 g	1,85 m	695 g





### Topic Z Cast 25

The all-round series in Zebco spinning rods. Outstanding carbon blanks ensure excellent casting qualities, allowing baits to be placed with precision even over long distances. The models available cover a vast range from the 25g trout rod to the 80g pike rod.

Code	Model	Length	Sections	C.W.	Tr.-Length	Weight
14107 180	Topic Z Cast 25	1,80 m	2	25 g	0,94 m	98 g
14107 210	Topic Z Cast 25	2,10 m	2	25 g	1,10 m	105 g
14107 240	Topic Z Cast 25	2,40 m	2	25 g	1,27 m	135 g
14107 270	Topic Z Cast 25	2,70 m	2	25 g	1,41 m	180 g
14108 210	Topic Z Cast 40	2,10 m	2	40 g	1,10 m	130 g
14108 240	Topic Z Cast 40	2,40 m	2	40 g	1,27 m	159 g
14108 270	Topic Z Cast 40	2,70 m	2	40 g	1,41 m	190 g
14109 210	Topic Z Cast 60	2,10 m	2	60 g	1,10 m	145 g
14109 240	Topic Z Cast 60	2,40 m	2	60 g	1,27 m	170 g
14109 270	Topic Z Cast 60	2,70 m	2	60 g	1,41 m	207 g
14109 300	Topic Z Cast 60	3,00 m	2	60 g	1,58 m	240 g
14110 240	Topic Z Cast 80	2,40 m	2	80 g	1,27 m	200 g
14110 270	Topic Z Cast 80	2,70 m	2	80 g	1,41 m	225 g



### Topic Z Cast Shad

Soft lures can be cast and retrieved perfectly with this rod. While heavy and stiff rods lack the necessary sensitivity, this balanced rod series ticks every box. Pike, zander, perch, as well as many a sea predator, will come to fear this rod.

Code	Model	Length	Sections	C.W.	Tr.-Length	Weight
14111 235	Topic Z Cast Shad	2,35 m	2	28 g	1,21 m	189 g
14111 265	Topic Z Cast Shad	2,65 m	2	43 g	1,36 m	222 g



### Topic Z Cast Aal

If you want your eel sessions to run smoothly, you need a reliable rod capable of bringing even the thicker specimens safely to the net. This special model was designed for precisely this purpose. Uncompromisingly good!

Code	Model	Length	Sections	C.W.	Tr.-Length	Weight
14112 270	Topic Z Cast Aal	2,70 m	2	90 g	1,41 m	225 g





### Cool Carp

Superb value carp rods in a choice of 2 or 3 piece blanks. The 3 piece model is made of carbon composite material while the 2 piece rods consist of particularly strong glass fibre.

Code	Model	Length	Sections	Tr-Length	Testcurve	Weight
1444 361	Cool Carp	3,60 m	2	1,84 m	2,75 lbs	472 g
1445 361	Cool Carp	3,60 m	3	1,26 m	2,75 lbs	485 g
1447 360	Cool Carp	3,60 m	2	1,84 m	3,00 lbs	460 g
1447 361	Cool Carp	3,60 m	2	1,84 m	3,50 lbs	472 g



### Stinger Spin

Light spinning rod range with powerful dynamic blanks, ideal for all freshwater fishing. Uncompromising quality at an affordable price. The right model for every situation imaginable.

Code	Model	Length	Sections	C.W.	Tr-Length	Weight
14140 180	20	1,80 m	2	3 - 20 g	0,94 m	160 g
14140 210	20	2,10 m	2	3 - 20 g	1,10 m	180 g
14141 240	25	2,40 m	2	3 - 25 g	1,26 m	200 g
14142 210	40	2,10 m	2	15 - 40 g	1,10 m	208 g
14142 240	40	2,40 m	2	15 - 40 g	1,26 m	230 g
14142 270	40	2,70 m	2	15 - 40 g	1,40 m	270 g
14143 240	70	2,40 m	2	30 - 70 g	1,26 m	240 g
14143 270	70	2,70 m	2	30 - 70 g	1,40 m	310 g
14143 300	70	3,00 m	2	30 - 70 g	1,56 m	370 g



### Stinger Eel

Two-piece leger rod with sufficient power in the blank for stalking nocturnal lurkers. Pike and zander? Bring them on!

Code	Model	Length	Sections	C.W.	Tr-Length	Weight
14145 270	Stinger Eel	2,70 m	2	60 g	1,40 m	310 g



### Stinger Distance Tele

The deadbait rods for fishing at long distance and targeting pike and zander lurking behind the edge of the weeds.

Code	Model	Length	Sections	C.W.	Tr-Length	Weight
17101 450	Stinger Distance Tele	4,50 m	6	150 g	1,10 m	500 g
17101 550	Stinger Distance Tele	5,50 m	7	150 g	1,15 m	720 g
17101 650	Stinger Distance Tele	6,50 m	8	150 g	1,20 m	860 g







### Telecast TR

Telecast – plenty of rod for little money. A value-for-money telescopic rod series that covers a broad angling spectrum. The Telecast TR series comprises telescopic rods with short sections making them ideal for small luggage

Code	Model	Length	Sections	C.W.	Tr.-Length	Weight
17500 180	30	1,80 m	5	10 - 30 g	0,45 m	120 g
17500 210	30	2,10 m	5	10 - 30 g	0,46 m	140 g
17500 240	40	2,40 m	6	20 - 40 g	0,56 m	160 g
17500 270	40	2,70 m	6	20 - 40 g	0,61 m	195 g
17500 300	50	3,00 m	7	25 - 50 g	0,61 m	210 g

### Telecast T

Telecast – plenty of rod for little money. A value-for-money telescopic rod series that covers a broad angling spectrum. The Telecast T40 series come in lengths of 2.4 m to 3.6 m and are designed for targeting trout, perch and silver fish.

Code	Model	Length	Sections	C.W.	Tr.-Length	Weight
17501 240	40	2,40 m	5	15 - 40 g	0,64 m	150 g
17501 270	40	2,70 m	6	15 - 40 g	0,65 m	195 g
17501 300	40	3,00 m	6	15 - 40 g	0,65 m	223 g
17501 360	40	3,60 m	7	15 - 40 g	0,67 m	262 g

### Telecast T

Telecast – plenty of rod for little money. A value-for-money telescopic rod series that covers a broad angling spectrum. The Telecast T60 series are the absolute all-rounders in the range. The powerful and flexible rods are suited to almost all types of freshwater angling.

Code	Model	Length	Sections	C.W.	Tr.-Length	Weight
17502 240	60	2,40 m	5	30 - 60 g	0,64 m	175 g
17502 270	60	2,70 m	6	30 - 60 g	0,65 m	215 g
17502 300	60	3,00 m	6	30 - 60 g	0,65 m	255 g
17502 360	60	3,60 m	7	30 - 60 g	0,67 m	295 g

### Telecast T

Telecast – plenty of rod for little money. A value-for-money telescopic rod series that covers a broad angling spectrum. The Telecast T80 series, with casting weights of up to 80 g, are designed for targeting large fish such as pike, carp, zander and eels. The rod has enough power in reserve to take on all comers.

Code	Model	Length	Sections	C.W.	Tr.-Length	Weight
17503 240	80	2,40 m	5	40 - 80 g	0,64 m	175 g
17503 270	80	2,70 m	6	40 - 80 g	0,65 m	225 g
17503 300	80	3,00 m	6	40 - 80 g	0,65 m	255 g
17503 330	80	3,30 m	7	40 - 80 g	0,67 m	278 g
17503 360	80	3,60 m	7	40 - 80 g	0,67 m	315 g

### Telecast T

Telecast – plenty of rod for little money. A value-for-money telescopic rod series that covers a broad angling spectrum. The Telecast T150 series is primarily designed for long-range fishing and legering on rivers and lakes. However, they are also suited to fishing from jetties or from the beach for light surf angling.

Code	Model	Length	Sections	C.W.	Tr.-Length	Weight
17504 270	150	2,70 m	6	60 - 150 g	0,65 m	225 g
17504 300	150	3,00 m	6	60 - 150 g	0,65 m	255 g
17504 360	150	3,60 m	7	60 - 150 g	0,67 m	315 g
17505 300	300	3,00 m	5	80 - 300 g	0,67 m	285 g
17505 360	360	3,60 m	6	80 - 300 g	0,68 m	345 g





### Atac Match

How can a quality match rod be so price perfect? Take a look at these quality rods.

Code	Model	Length	Sections	C.W.	Tr.-Length	Weight
1482 360	Atac Match	3,60 m	3	15 g	1,25 m	318 g



### Atac Feeder

A range of rods designed for fishing successful and easy, even longer ranges. With perfectly designed actions, these rods can launch even large swimfeeders over very long distances on stillwaters or powerful rivers.

Code	Model	Length	Sections	C.W.	Tr.-Length	F.Tips	Weight
1483 300	Atac Feeder	3,00 m	3	80 g	1,05 m	2	213 g
1483 330	Atac Feeder	3,30 m	3	80 g	1,15 m	2	225 g
1483 360	Atac Feeder	3,60 m	3	80 g	1,25 m	2	243 g



### Atac Heavy Feeder

Suitable for heavy feeders and fishing at a distance. With its two spare tips this heavy feeder rod is suitable for a variety of venues and conditions.

Code	Model	Length	Sections	C.W.	Tr.-Length	F.Tips	Weight
1483 390	Atac Heavy Feeder	3,90 m	3	180 g	1,25 m	2	453 g



### Atac Picker

A choice of 2 lengths in this budget priced 'Lead' rod. 2 piece blanks with 2 interchangeable tips. Quality guides throughout.

Code	Model	Length	Sections	C.W.	Tr.-Length	F.Tips	Weight
1484 240	Atac Picker	2,40 m	2	60 g	1,26 m	2	172 g
1484 270	Atac Picker	2,70 m	2	60 g	1,41 m	2	203 g



### Atac Tele Feeder 100

Telescopic rods that are extremely easy to transport, and yet with astonishing performance. Supplied with interchangeable tips.

Code	Model	Length	Sections	C.W.	Tr.-Length	F.Tips	Weight
1484 211	Atac Tele Feeder 100	2,10 m	4	100 g	0,57 m	3	202 g
1484 241	Atac Tele Feeder 100	2,40 m	5	100 g	0,58 m	3	249 g
1484 271	Atac Tele Feeder 100	2,70 m	5	100 g	0,60 m	3	265 g
1484 301	Atac Tele Feeder 100	3,00 m	6	100 g	0,65 m	3	335 g
1484 331	Atac Tele Feeder 100	3,30 m	6	100 g	0,70 m	3	358 g
1484 361	Atac Tele Feeder 100	3,60 m	7	100 g	0,72 m	3	450 g

Code	Model	provided Feeder Tips
1484 211	Atac Tele Feeder 100	1, 2, 3 oz
1484 241	Atac Tele Feeder 100	1, 2, 3 oz
1484 271	Atac Tele Feeder 100	1, 2, 3 oz
1484 301	Atac Tele Feeder 100	1, 2, 3 oz
1484 331	Atac Tele Feeder 100	1, 2, 3 oz
1484 361	Atac Tele Feeder 100	1, 2, 3 oz





### King Kayak

Short specialist rods with a robust fibreglass blank for fishing from a kayak. With a short length, the relatively soft action is essential to guarantee sufficient cushioning during the fight. The ultra-powerful tip of the King Kayak allows baits to be cast out over long distances despite the short rod length. The low test curve should therefore cause little concern: this rod will tame powerful predators such as pike or bass. Available in blue and black or pink and black.

Code	Model	Length	Sections	Tr.-Length	Testcurve	Weight
1050 075	King Kayak	0,75 m	1	0,75 m	12 oz	92 g
1050 100	King Kayak	1,00 m	1	1,00 m	12 oz	110 g
1051 075	King Kayak	0,75 m	1	0,75 m	1,25 lbs	96 g
1051 100	King Kayak	1,00 m	1	1,00 m	1,25 lbs	116 g



### Cool Solid

A great value solid glass rod for boat fishing - unbreakable!!!

Code	Model	Length	Sections	C.W.	Tr.-Length	Weight
1430 100	Cool Solid	1,00 m	1	100 - 200 g	1,00 m	120 g
1430 120	Cool Solid	1,20 m	1	100 - 200 g	1,20 m	150 g



### Cool Solid X

Finally, these popular blue glass rods are now available in longer lengths. For easier transport they come in a two-piece design.

Code	Model	Length	Sections	C.W.	Tr.-Length	Weight
1431 210	Cool Solid X	2,10 m	2	100 - 200 g	1,10 m	471 g



### Cool Mini Tele

The telescopic COOL MINI rod was especially designed for travelling, backpacks and bike bags. You can pack 'em, but whether you can haul in the big fish with them is another question! Maybe if you keep a cool head...

Code	Model	Length	Sections	C.W.	Tr.-Length	Weight
1530 165	Cool Mini Tele	1,65 m	5	5 - 15 g	0,42 m	100 g
1530 180	Cool Mini Tele	1,80 m	6	10 - 25 g	0,42 m	130 g
1530 210	Cool Mini Tele	2,10 m	6	10 - 25 g	0,45 m	150 g
1530 240	Cool Mini Tele	2,40 m	6	20 - 30 g	0,56 m	170 g
1530 270	Cool Mini Tele	2,70 m	6	20 - 30 g	0,62 m	220 g



### Atac Tele SF

The rod that gets you hooked on fishing! Hundreds of thousands of anglers have taken their first steps in the sport with a simple telescopic whip, and generations more are sure to continue the tradition. A must for all tackle shops, available in all the most popular lengths.

Code	Model	Length	Sections	Tr.-Length	Weight
10005 300	300	3,00 m	3	1,17 m	125 g
10005 400	400	4,00 m	4	1,17 m	236 g
10005 500	500	5,00 m	5	1,17 m	392 g
10005 600	600	6,00 m	6	1,17 m	498 g
10005 700	700	7,00 m	7	1,17 m	748 g





**Super-hard Telescopic Rod Ring**

Code	Ø Ring	Ø Tube
1650 025	4,4 mm	2,5 mm
1650 028	4,4 mm	2,8 mm
1650 030	4,4 mm	3,0 mm
1650 032	4,4 mm	3,2 mm
1650 035	4,4 mm	3,5 mm
1650 038	4,4 mm	3,8 mm
1650 040	5,5 mm	4,0 mm
1650 045	5,5 mm	4,5 mm
1650 050	6,6 mm	5,0 mm
1650 055	6,6 mm	5,5 mm
1650 060	6,6 mm	6,0 mm
1650 065	6,6 mm	6,5 mm
1650 070	6,6 mm	7,0 mm
1650 075	6,6 mm	7,5 mm
1650 080	8,9 mm	8,0 mm
1650 085	8,9 mm	8,5 mm
1650 090	8,9 mm	9,0 mm
1650 095	8,9 mm	9,5 mm
1650 100	8,9 mm	10,0 mm
1650 105	8,9 mm	10,5 mm
1650 110	8,9 mm	11,0 mm
1650 115	8,9 mm	11,5 mm
1650 120	11,8 mm	12,0 mm
1650 125	11,8 mm	12,5 mm
1650 130	11,8 mm	13,0 mm
1650 135	11,8 mm	13,5 mm
1650 140	11,8 mm	14,0 mm
1650 145	11,8 mm	14,5 mm
1650 150	15,3 mm	15,0 mm
1650 155	15,3 mm	15,5 mm
1650 160	15,3 mm	16,0 mm
1650 165	15,3 mm	16,5 mm
1650 170	15,3 mm	17,0 mm
1650 175	15,3 mm	17,5 mm
1650 180	20,5 mm	18,0 mm
1650 185	20,5 mm	18,5 mm
1650 190	20,5 mm	19,0 mm
1650 195	20,5 mm	19,5 mm
1650 200	20,5 mm	20,0 mm
1650 210	20,5 mm	21,0 mm
1650 220	20,5 mm	22,0 mm
1650 230	20,5 mm	23,0 mm
1650 240	20,5 mm	24,0 mm
1650 250	20,5 mm	25,0 mm

Trade Pack 5 Pieces

**SIC Telescopic Rod Ring**

Code	Ø Ring	Ø Tube
1660 025	5,0 mm	2,5 mm
1660 028	5,0 mm	2,8 mm
1660 030	5,0 mm	3,0 mm
1660 032	5,0 mm	3,2 mm
1660 035	5,0 mm	3,5 mm
1660 038	5,0 mm	3,8 mm
1660 040	6,5 mm	4,0 mm
1660 045	6,5 mm	4,5 mm
1660 050	7,7 mm	5,0 mm
1660 055	7,7 mm	5,5 mm
1660 060	7,7 mm	6,0 mm
1660 065	7,7 mm	6,5 mm
1660 070	7,7 mm	7,0 mm
1660 075	7,7 mm	7,5 mm
1660 080	10,1 mm	8,0 mm
1660 085	10,1 mm	8,5 mm
1660 090	10,1 mm	9,0 mm
1660 095	10,1 mm	9,5 mm
1660 100	10,1 mm	10,0 mm
1660 105	10,1 mm	10,5 mm
1660 110	10,1 mm	11,0 mm
1660 115	10,1 mm	11,5 mm
1660 120	13,7 mm	12,0 mm
1660 125	13,7 mm	12,5 mm
1660 130	13,7 mm	13,0 mm
1660 135	13,7 mm	13,5 mm
1660 140	13,7 mm	14,0 mm
1660 145	17,7 mm	14,5 mm
1660 150	17,7 mm	15,0 mm
1660 155	17,7 mm	15,5 mm
1660 160	17,7 mm	16,0 mm
1660 165	17,7 mm	16,5 mm
1660 170	17,7 mm	17,0 mm
1660 175	17,7 mm	17,5 mm
1660 180	23,1 mm	18,0 mm
1660 185	23,1 mm	18,5 mm
1660 190	23,1 mm	19,0 mm
1660 195	23,1 mm	19,5 mm
1660 200	23,1 mm	20,0 mm
1660 205	23,1 mm	20,5 mm
1660 210	23,1 mm	21,0 mm
1660 215	23,1 mm	21,5 mm
1660 220	23,1 mm	22,0 mm
1660 225	23,1 mm	22,5 mm
1660 230	23,1 mm	23,0 mm
1660 235	23,1 mm	23,5 mm
1660 240	23,1 mm	24,0 mm
1660 245	23,1 mm	24,5 mm
1660 250	23,1 mm	25,0 mm
1660 255	23,1 mm	25,5 mm
1660 260	23,1 mm	26,0 mm

Trade Pack 5 Pieces



**SIC End Ring with tube**

Code	Ø Ring	Ø Tube
1661 014	3,5 mm	1,4 mm
1661 016	3,5 mm	1,6 mm
1661 018	3,5 mm	1,8 mm
1661 020	5,8 mm	2,0 mm
1661 022	5,8 mm	2,2 mm
1661 024	5,8 mm	2,4 mm
1661 026	5,8 mm	2,6 mm
1661 028	6,5 mm	2,8 mm
1661 030	6,5 mm	3,0 mm
1661 036	10,1 mm	3,6 mm
1661 038	10,1 mm	3,8 mm
1661 040	13,7 mm	4,0 mm
1661 042	13,7 mm	4,2 mm
1661 045	13,7 mm	4,5 mm

Trade Pack 5 Pieces



**Super-hard Rod Tip Ring**

Code	Ø Ring	Ø Tube
1656 020	4,4 mm	2,0 mm
1656 022	4,4 mm	2,2 mm
1656 024	4,4 mm	2,4 mm
1656 026	4,4 mm	2,6 mm
1656 028	5,5 mm	2,8 mm
1656 030	5,5 mm	3,0 mm
1656 032	5,5 mm	3,2 mm
1656 035	5,5 mm	3,5 mm
1656 040	6,6 mm	4,0 mm
1656 045	6,6 mm	4,5 mm
1656 050	8,9 mm	5,0 mm
1656 055	8,9 mm	5,5 mm
1656 060	8,9 mm	6,0 mm
1656 065	8,9 mm	6,5 mm
1656 070	11,8 mm	7,0 mm
1656 075	11,8 mm	7,5 mm

Trade Pack 5 Pieces



**SIC Match End Ring**

Code	Ø Ring	Ø Tube
1665 012	2,0 mm	1,2 mm
1665 014	2,0 mm	1,4 mm
1665 016	2,6 mm	1,6 mm
1665 018	2,6 mm	1,8 mm
1665 020	2,6 mm	2,0 mm
1665 022	2,6 mm	2,2 mm

Trade Pack 5 Pieces

**Roller End Ring**

Code	Ø Tube
1675 041	4,1 mm
1675 051	5,1 mm
1675 061	6,1 mm
1675 071	7,1 mm
1675 081	8,1 mm
1675 091	9,1 mm

Trade Pack 5 Pieces

**SIC Single-Leg Intermediate Ring**

Code	Ø Ring
1663 006	3,5 mm
1663 008	5,0 mm
1663 010	6,5 mm
1663 012	7,7 mm
1663 016	10,1 mm
1663 020	13,7 mm
1663 025	17,7 mm
1663 030	23,1 mm

Trade Pack 5 Pieces

**SIC Double Leg Ring**

Code	Ø Ring
1664 006	3,5 mm
1664 008	5,0 mm
1664 010	6,5 mm
1664 012	7,7 mm
1664 016	10,1 mm
1664 020	13,7 mm
1664 025	17,7 mm
1664 030	23,1 mm
1664 035	28,0 mm

Trade Pack 5 Pieces

**SIC-Match Ring**

Code	Ø Ring
1666 005	2,6 mm
1666 006	3,5 mm
1666 008	5,0 mm
1666 010	6,5 mm
1666 012	7,7 mm

Trade Pack 5 Pieces

**SIC Match End Ring**

Code	Ø Ring	Ø Tube
1667 016	2,6 mm	1,6 mm
1667 020	2,6 mm	2,0 mm
1667 024	3,5 mm	2,4 mm

Trade Pack 5 Pieces



**SIC Surf-Rod Ring, foldable**

Code	Ø Ring
1659 030	22,8 mm
1659 040	28,3 mm

Trade Pack 5 Pieces



**Plate Reel Seat, black**

Code	Length	Size
1713 014	14 cm	S
1713 018	16 cm	M

Trade Pack 5 Pieces



**Sic-End Ring**

SIC-Inlay especially gentle to the line!

Code	Ø Ring	Ø Tube
1668 010	4,4 mm	1,0 mm
1668 015	4,4 mm	1,5 mm
1668 020	4,4 mm	2,0 mm
1668 025	4,4 mm	2,5 mm
1668 120	5,8 mm	2,0 mm
1668 125	5,8 mm	2,5 mm
1668 130	5,8 mm	3,0 mm
1668 225	6,7 mm	2,5 mm
1668 230	6,7 mm	3,0 mm
1668 235	6,7 mm	3,5 mm
1668 240	6,7 mm	4,0 mm
1668 245	6,7 mm	4,5 mm
1668 330	8,8 mm	3,0 mm
1668 335	8,8 mm	3,5 mm
1668 340	8,8 mm	4,0 mm
1668 345	8,8 mm	4,5 mm
1668 350	8,8 mm	5,0 mm
1668 355	8,8 mm	5,5 mm

Trade Pack 5 Pieces



**Ring Insert**

Ideal for replacing slivered rings. Standard sizes to fit customary rings.

Code	Ø	Content	Colour
1671 008	8 mm	5 pcs	grey
1671 010	10 mm	5 pcs	grey
1671 012	12 mm	5 pcs	grey
1671 016	16 mm	5 pcs	grey
1671 020	20 mm	5 pcs	grey
1671 025	25 mm	5 pcs	grey
1671 030	30 mm	5 pcs	grey
1671 040	40 mm	5 pcs	grey
1671 050	50 mm	5 pcs	grey

Trade Pack 5 Pieces





### Telescopic Rod Slide Ring

Ideal as additional rings between telescopic connections.

Code	Ø Ring	Ø Tube
1669 016	3,5 mm	1,6 mm
1669 018	3,5 mm	1,8 mm
1669 021	4,4 mm	2,1 mm
1669 024	4,4 mm	2,4 mm
1669 027	5,0 mm	2,7 mm
1669 030	5,0 mm	3,0 mm
1669 032	5,0 mm	3,2 mm
1669 034	5,0 mm	3,4 mm
1669 036	5,0 mm	3,6 mm
1669 126	5,3 mm	2,6 mm
1669 128	5,3 mm	2,8 mm
1669 130	5,3 mm	3,0 mm
1669 135	6,3 mm	3,5 mm
1669 138	6,3 mm	3,8 mm
1669 140	6,3 mm	4,0 mm
1669 144	6,3 mm	4,4 mm

Trade Pack 5 Pieces



All reels loaded with suitable line

### Cool Expert FD

Robust and proven Zebco reel quality. Supplied in boxes of 20 units, each containing 10 in black and silver and 10 in black and red. Attractive for resellers.

Code	Model	Weight
0010 020	120	195 g
0010 030	130	205 g
0010 050	150	330 g
0010 065	165	375 g

Trade Pack 20 Pieces



All reels loaded with suitable line

### Cool Expert RD

Robust and proven Zebco reel quality. Supplied in boxes of 20 units, each containing 10 in black and silver and 10 in black and red. Attractive for resellers.

Code	Model	Weight
0020 030	130	228 g
0020 050	150	335 g

Trade Pack 20 Pieces



All reels loaded with suitable line

### Cool Expert BR

Robust and proven Zebco reel quality. Supplied in boxes of 20 units in black and silver. Attractive for resellers.

Code	Model	Weight
0010 165	165	400 g

Trade Pack 20 Pieces



### Cool Expert Tele Pike

Rods optimised to the target species. Supplied in boxes of 20 units in three attractive colour combinations to catch the customer's eye and stand out in the shop. Attractive for resellers.

Code	Length	Weight	Sections	C.W.	Tr.-Length
1077 350	3,50 m	378 g	4	100 g	1,12 m
1077 351	3,50 m	354 g	4	70 g	1,12 m



### Cool Expert Tele Spin

Rods optimised to the target species. Supplied in boxes of 20 units in three attractive colour combinations to catch the customer's eye and stand out in the shop. Attractive for resellers.

Code	Length	Weight	Sections	C.W.	Tr.-Length
1079 180	1,80 m	400 g	6	10 - 40 g	0,60 m
1079 210	2,10 m	420 g	6	20 - 50 g	0,60 m
1079 240	2,40 m	181 g	7	20 - 50 g	0,61 m



### Cool Expert Carp

Rods optimised to the target species. Supplied in boxes of 20 units in black. Attractive for resellers.

Code	Length	Weight	Sections	C.W.	Tr.-Length
1082 360	3,60 m	457 g	2	3 lbs	1,87 m
1082 361	3,60 m	395 g	3	3 lbs	1,28 m





**Cool Expert Surf**

Rods optimised to the target species. Supplied in boxes of 20 units in three attractive colour combinations to catch the customer's eye and stand out in the shop. Attractive for resellers.

Code	Length	Weight	Sections	C.W.	Tr.-Length
1083 420	4,20 m	840 g	3	100 - 200 g	1,50 m



**Cool Expert Holiday**

Rods optimised to the target species. Supplied in boxes of 20 units in three attractive colour combinations to catch the customer's eye and stand out in the shop. Attractive for resellers.

Code	Length	Weight	Sections	Tr.-Length
1084 300	3,00 m	127 g	3	1,16 m
1084 400	4,00 m	237 g	4	1,16 m
1084 500	5,00 m	368 g	5	1,16 m

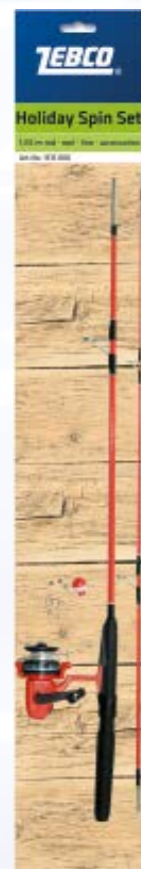

**Holiday Spin Set**

1,65m rod with reel, line and accessories.

Code	Length	Weight	C.W.	Tr.-Length
1515 000	1,65 m	200 g	25 g	0,81 m

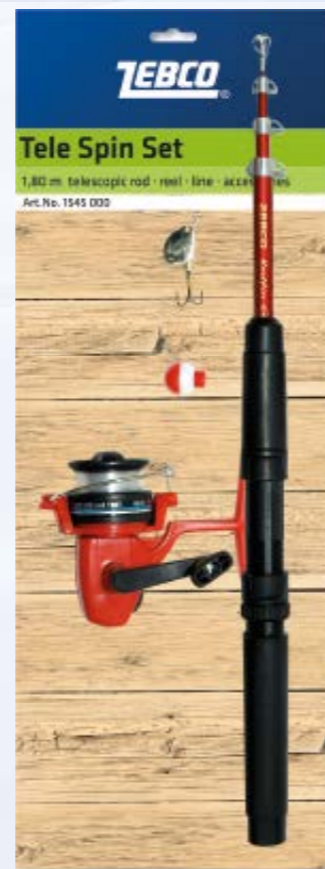

**Tele Spin Set**

1,80m telescopic rod with reel, line and accessories

Code	Length	Weight	C.W.	Tr.-Length
1545 000	1,80 m	180 g	25 g	0,45 m



**Feeder Combo**

3.6-metre feeder rod with size 30 rear-drag reel, suitable line and an assortment of tackle: 3 different swimfeeders, 3 leger weights, disgorger, 20 lead shot in two sizes, 20 swivels in two designs, 20 tied hooks in two sizes, 15 line stoppers and 35 beads, and all in a transparent tackle box. 120 items in all.

Code	Length	Weight	Sections	C.W.	Tr.-Length
1545 020	3,60 m	300 g	3	80 - 100 g	1,70 m



**Pole Combo**

3-metre fibreglass whip with an assortment of tackle: 6 floats, 2 rigs, 40 float rubbers, 20 tied hooks in two sizes, disgorger, 20 lead shot in two sizes, 10 swivels, 10 artificial lures (joker), 1 plummet, and all in a transparent tackle box. 130 items in all.

Code	Length	Weight	Sections	Tr.-Length
1545 021	3,00 m	125 g	4	1,15 m



**Pike / Zander Combo**

2.7-metre spinning rod with size 30 front-drag reel, suitable line and an assortment of tackle: 1 spoon, 2 spinners, 1 wobbler, 8 twisters, 3 soft lures, 10 swivels in two sizes, 10 lead shot in two sizes, 3 steel leaders, 1 predator float, 3 treble hooks, 2 jigheads, 5 snaplights, and all in a transparent tackle box. 50 items in all.

Code	Length	Weight	Sections	C.W.	Tr.-Length
1545 023	2,70 m	558 g	2	70 g	1,40 m

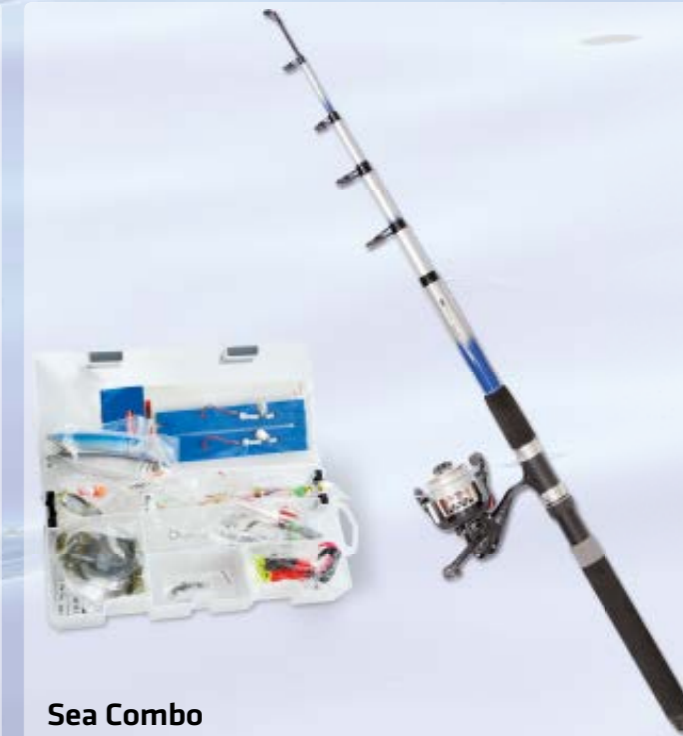

**Sea Combo**

2.7-metre telescopic rod for sea fishing with size 50 front-drag reel, suitable line and an assortment of tackle: 2 pirkers, 2 artificial crabs, 1 piking rig, 2 cod rigs, 2 flat-fish rigs, 1 herring leader, 1 herring weight, 1 surf lead, 10 deep-sea swivels and 1 mackerel Leader, and all in a transparent tackle box. 25 items in all.

Code	Length	Weight	Sections	C.W.	Tr.-Length
1545 024	2,70 m	650 g	5	150 g	0,70 m





**Eel Set**

Eel fishing tackle set comprising 18 tied hooks in two sizes, 1 worm box, 2 floats, 5 swivels, 5 leads or lead shot sets, disgorger, 2 snaplights, 8 rubber beads, 15 line stoppers, 8 stopper beads and 1 eel bell.

Code	Content
3610 108	67 items
Trade Pack 5 Pieces	



**Herring Set**

Herring fishing tackle set comprising 3 herring leaders, 2 herring weights, 6 swivels and 1 filleting knife.

Code	Content
3610 109	12 items
Trade Pack 5 Pieces	



**Ice Fisher Set**

Ice fishing lure set comprising 9 attractive ice fishing lures for vertical fishing.

Code	Content
3610 112	9 items
Trade Pack 5 Pieces	



**Garfish Set**

Garfish tackle set comprising 1 bubble float, 1 sbirulino, 1 garfish spoon, 10 tied hooks, 1 filleting knife, 8 rubber and stopper beads, 5 safety swivels and a disgorger.

Code	Content
3610 113	36 items
Trade Pack 5 Pieces	



**Mackerel and Coalfish Set**

Mackerel and coalfish tackle set comprising 3 deep-sea rigs and 2 pirkers, 6 sea swivels and 1 filleting knife.

Code	Content
3610 110	14 items
Trade Pack 5 Pieces	



**Surf Set**

Surf angling tackle set comprising 2 rigs, surf lead, 1 filleting knife, 2 snaplights, 6 swivels, 1 worm needle, and 1 pair of forceps.

Code	Content
3610 111	14 items
Trade Pack 5 Pieces	



**Bay Hunter Set**

Attractive set comprising a wobbler, pirker and sand eel imitation – perfect for targeting bass as well as for other types of sea spinning.

Code	Content
3609 001	
Trade Pack 5 Pieces	



**Sea Soft Lure Set**

Five different soft lures and three different weight heads for targeting bass, cod and pollock from the shore, as well as for boat fishing.

Code	Content
3609 002	
Trade Pack 5 Pieces	





**Coarse Set**

What more could the occasional angler wish for? This 100-piece accessory box practically wipes out the shopping list – whether for float or ledger fishing!

Code	Content
3610 101	100 items
Trade Pack 5 Pieces	



**Trout Set**

28-piece float set with accessories for trout anglers. Includes shot, swivels, leaders and disgorger.

Code	Content
3610 102	28 items
Trade Pack 5 Pieces	



**Pike Spin Set**

Code	Content
3610 103	12 items
Trade Pack 5 Pieces	



**Zander/Perch Set**

Code	Content
3610 105	80 items
Trade Pack 5 Pieces	



**Trout Set**

Everything the trout angler could wish for: this 70-piece accessory box will equip you for all eventualities. With everything from float to disgorger, you are ready to enjoy some fishing.

Code	Content
3610 106	70 items
Trade Pack 5 Pieces	

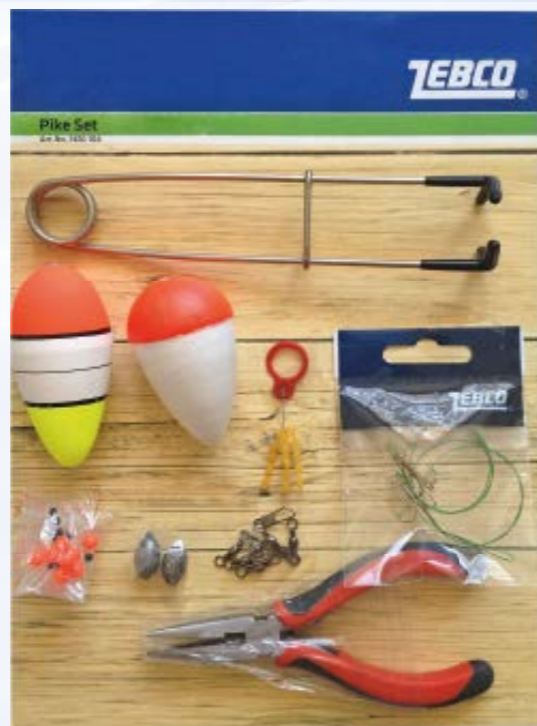

**Pike Set**

Code	Content
3610 104	45 items
Trade Pack 5 Pieces	



**Plug Set**

Code	Content
3610 107	11 items
Trade Pack 5 Pieces	







### Trophy Carp

Trophy Carp is adapted to the habitat of the big, shy and suspicious carp, with its boggy brown colour. Zebco has therefore developed a soft, supple line of great elasticity, with optimum knot strength and abrasion resistance.

Code	Ø	Length	BS	Colour
2034 125	0,25 mm	540 m	5,0 kg	black
2034 128	0,28 mm	500 m	5,9 kg	black
2034 130	0,30 mm	450 m	6,9 kg	black
2034 132	0,32 mm	450 m	7,5 kg	black
2034 135	0,35 mm	315 m	9,2 kg	black
2034 138	0,38 mm	315 m	11,0 kg	black
2034 140	0,40 mm	245 m	12,7 kg	black

Trade Pack 10 Pieces

### Trophy Carp

Trophy Carp is adapted to the habitat of the big, shy and suspicious carp, with its boggy brown colour. Zebco has therefore developed a soft, supple line of great elasticity, with optimum knot strength and abrasion resistance.

Code	Ø	Length	BS	Colour
2034 025	0,25 mm	540 m	5,0 kg	brown
2034 028	0,28 mm	500 m	5,9 kg	brown
2034 030	0,30 mm	450 m	6,9 kg	brown
2034 032	0,32 mm	450 m	7,5 kg	brown
2034 035	0,35 mm	315 m	9,2 kg	brown

Trade Pack 10 Pieces

### Trophy Zander

The order of the day when catching the shy zander is to have a soft, supple and knot tight line. The excellent abrasion resistance means that even zander can be caught without problem and without a KEVLAR cast.

Code	Ø	Length	BS
2039 022	0,22 mm	540 m	4,2 kg
2039 025	0,25 mm	540 m	5,0 kg
2039 028	0,28 mm	500 m	5,9 kg
2039 030	0,30 mm	450 m	6,9 kg
2039 032	0,32 mm	450 m	7,5 kg

Trade Pack 10 Pieces

### Trophy Trout

A trout line must cope with all situations. It provides the best bait control through its softness and suppleness. Absolute flexibility is essential for these jumping and powerful salmonides. The smoke grey colour of the TOPIC TROUT means that it is adapted to any type of water.

Code	Ø	Length	BS
2038 018	0,18 mm	540 m	2,9 kg
2038 020	0,20 mm	540 m	3,6 kg
2038 022	0,22 mm	540 m	4,2 kg
2038 025	0,25 mm	540 m	5,0 kg
2038 028	0,28 mm	500 m	5,9 kg
2038 030	0,30 mm	450 m	7,5 kg

Trade Pack 10 Pieces



### Trophy Eel

These grey sneakers need something special. TOPIC EEL is uncompromisingly strong and has top specification to extract even the largest eels from their lairs.

Code	Ø	Length	BS
2037 035	0,35 mm	315 m	9,2 kg
2037 040	0,40 mm	245 m	12,7 kg

Trade Pack 10 Pieces

### Trophy Pike

The TOPIC PIKE camouflage is as green as the covering of water plants. Minimum stretch is a must in order to accommodate the consistent lifts, even at a distance.

Code	Ø	Length	BS
2033 025	0,25 mm	540 m	5,0 kg
2033 028	0,28 mm	500 m	5,9 kg
2033 030	0,30 mm	450 m	6,9 kg
2033 035	0,35 mm	315 m	9,2 kg
2033 040	0,40 mm	245 m	12,7 kg
2033 045	0,45 mm	180 m	14,9 kg

Trade Pack 10 Pieces

### Trophy Cod

In order to raise cod from the deep, the line must have optimum characteristics with respect to stretch, breaking strain, knot strength and abrasion resistance. The lure guide is now even more visible because of the yellow colouring.

Code	Ø	Length	BS
2035 040	0,40 mm	245 m	12,7 kg
2035 045	0,45 mm	180 m	14,9 kg
2035 050	0,50 mm	180 m	17,9 kg

Trade Pack 10 Pieces

### Trophy Catfish

The greyish green camouflage has been tuned to the habitat of these large beasts. In order to be sure of landing these large fish the line must have maximum breaking strain, an abrasion resistant surface, maximum knot strength and still remain flexible.

Code	Ø	Length	BS
2032 045	0,45 mm	180 m	14,9 kg
2032 050	0,50 mm	180 m	18,1 kg
2032 055	0,55 mm	150 m	21,5 kg
2032 060	0,60 mm	130 m	23,4 kg

Trade Pack 10 Pieces





**Trophy Livebait**

A fluorescent yellow line which will allow you permanent direct sight of the line whilst playing the finest pike, zander and perch.

Code	Ø	Length	BS
2027 025	0,25 mm	540 m	5,0 kg
2027 028	0,28 mm	450 m	5,9 kg
2027 030	0,30 mm	315 m	6,9 kg
2027 035	0,35 mm	245 m	9,2 kg

Trade Pack 10 Pieces



**Gilt Head**

With its brilliant florescent colours its high visibility is perfect for fishing either in fresh water or on the shore. Its special coating will allow you to cast greater distances.

Code	Ø	Length	BS
2026 030	0,30 mm	450 m	6,9 kg
2026 035	0,35 mm	315 m	9,2 kg
2026 040	0,40 mm	240 m	12,7 kg

Trade Pack 10 Pieces



**Trophy Boat**

Special sea fishing line whose transparency makes it almost invisible to fish when underwater. The line is also abrasion resistant and protected against the effects of UV rays. Its excellent stretch qualities minimise losing fish while bringing them to the bank.

Code	Ø	Length	BS
2040 040	0,40 mm	300 m	12,7 kg
2040 045	0,45 mm	300 m	14,9 kg
2040 050	0,50 mm	300 m	17,9 kg
2040 060	0,60 mm	300 m	23,4 kg

Trade Pack 10 Pieces



**Trophy Universal**

Allround line at value for money on 100m spools, in grey and green colour and available in the most common diameters. Sure to be a mega seller in every angling community with the traditional Trophy qualities such as high breaking strain and optimum abrasion resistance.

Code	Ø	Length	BS
2041 014	0,14 mm	100 m	1,6 kg
2041 016	0,16 mm	100 m	2,0 kg
2041 018	0,18 mm	100 m	2,6 kg
2041 020	0,20 mm	100 m	3,0 kg
2041 025	0,25 mm	100 m	4,7 kg
2041 030	0,30 mm	100 m	6,6 kg
2041 035	0,35 mm	100 m	8,3 kg
2041 040	0,40 mm	100 m	10,8 kg

Trade Pack 10 Pieces



**Trophy Sea Bass**

This line had to be designed tough, with a low elasticity coefficient in order to absorb the very powerful movements of the bass during the fight. Features extremely high knot strength. Its light blue colouring makes it practically invisible in the water.

Code	Ø	Length	BS
2025 030	0,30 mm	450 m	6,9 kg
2025 035	0,35 mm	315 m	9,2 kg

Trade Pack 10 Pieces



**Trophy Surf**

A pearly effect line with all the characteristics required for sea fishing. It is almost totally invisible in the water - a real advantage when preparing rigs with multiple knots which are generally fairly visible to the prey.

Code	Ø	Length	BS
2023 030	0,30 mm	450 m	6,9 kg
2023 035	0,35 mm	315 m	9,2 kg
2023 040	0,40 mm	245 m	12,7 kg
2023 045	0,45 mm	225 m	14,9 kg

Trade Pack 10 Pieces



**OMX Braid**

Interwoven braid that has been extremely tight knitted, made of UHM polyethylene. With demanding load capacities and super elongation this braid can easily be mistaken for products of much higher price. Ideal for the many disciplines of modern day spin fishing or sea angling. The braid colour provides excellent camouflage to unsuspecting fish, that can only be an advantage to an angler. Topic OMX Braid - The line for the ambitious angler.

Code	Ø	Length	BS
2659 016	0,16 mm	100 m	7,5 kg / 16,5 lbs
2659 018	0,18 mm	100 m	9,7 kg / 21,0 lbs
2659 020	0,20 mm	100 m	11,0 kg / 24,0 lbs
2659 022	0,22 mm	100 m	13,5 kg / 29,0 lbs
2659 024	0,24 mm	100 m	16,0 kg / 35,0 lbs

Trade Pack 5 Pieces



**OMX Braid**

Interwoven braid that has been extremely tight knitted, made of UHM polyethylene. With demanding load capacities and super elongation this braid can easily be mistaken for products of much higher price. Ideal for the many disciplines of modern day spin fishing or sea angling. The braid colour provides excellent camouflage to unsuspecting fish, that can only be an advantage to an angler. Topic OMX Braid - The line for the ambitious angler.

Code	Ø	Length	BS
2659 116	0,16 mm	250 m	7,5 kg / 16,5 lbs
2659 118	0,18 mm	250 m	9,7 kg / 21,0 lbs
2659 120	0,20 mm	250 m	11,0 kg / 24,0 lbs
2659 122	0,22 mm	250 m	13,5 kg / 29,0 lbs
2659 124	0,24 mm	250 m	16,0 kg / 35,0 lbs

Trade Pack 3 Pieces





**Trophy DC Taper Line**

The line for surf fishing. With a length of 220 metres and strength of 0.57 mm diameter, this is the real professional line for distance surf casting. This line is characterised by its exceptional knot strength, good carrying capacity, flexibility and abrasion resistance and by the coloured marking of the line after 25 metres.

Code	Ø	Length	Content
2216 028	0,28 mm / 0,57 mm	220 m	1 pcs
2216 030	0,30 mm / 0,57 mm	220 m	1 pcs
2216 033	0,33 mm / 0,57 mm	220 m	1 pcs

Trade Pack 5 Pieces



**Steel Leader**

Nylon coated steel leaders with snap hook and swivel, 72 leaders on a card with breaking strains of 6kg, 9kg and 12kg.

Code	Length
2320 001	10 cm / 15 cm / 21 cm



**Steel Leader**

Nylon coated steel leaders with snap hook and swivel, 72 leaders on a card with breaking strains of 6kg, 9kg and 12kg.

Code	Length
2320 002	30 cm



**Steel Leader**

Nylon coated steel leaders with snap hook and swivel, 72 leaders on a card with breaking strains of 6kg, 9kg and 12kg.

Code	Length
2320 003	15 cm / 21 cm



**Great White™ Braid**

Value-for-money braid for a wide range of applications with an attractive orange colouring. Filling your reel will not leave a big hole in your wallet and you can still enjoy the benefits of braided line, such as extreme breaking strain combined with low elasticity. Practical 300 m spool.

Code	Ø	Length	BS	Colour
2360 025	0,25 mm	300 m	12,00 kg / 26 lbs	orange
2360 027	0,27 mm	300 m	16,00 kg / 35 lbs	orange
2360 030	0,30 mm	300 m	18,00 kg / 40 lbs	orange
2360 033	0,33 mm	300 m	21,00 kg / 46 lbs	orange
2360 035	0,35 mm	300 m	23,00 kg / 51 lbs	orange
2360 038	0,38 mm	300 m	26,00 kg / 58 lbs	orange

Trade Pack 5 Pieces



**Great White™ Braid**

Value-for-money braid for a wide range of applications with an attractive orange colouring. Filling your reel will not leave a big hole in your wallet and you can still enjoy the benefits of braided line, such as extreme breaking strain combined with low elasticity. Economic 1000 m spool.

Code	Ø	Length	BS	Colour
2361 025	0,25 mm	1000 m	12,00 kg / 27 lbs	orange
2361 027	0,27 mm	1000 m	16,00 kg / 35 lbs	orange
2361 030	0,30 mm	1000 m	18,00 kg / 40 lbs	orange
2361 033	0,33 mm	1000 m	21,00 kg / 46 lbs	orange
2361 035	0,35 mm	1000 m	23,00 kg / 51 lbs	orange
2361 038	0,38 mm	1000 m	26,00 kg / 58 lbs	orange

**Steel Leader**

3 nylon coated leaders in a pack.

Code	Model	Hook Size	Length	BS	Content
4223 003	Single Hook	2	30 cm	12 kg	3 pcs
4223 006	Single Hook	4	30 cm	6 kg	3 pcs

Trade Pack 10 Pieces



**Steel Leader**

3 nylon coated leaders in a pack.

Code	Model	Hook Size	Length	BS	Content
4225 001	Treble Hook	1	30 cm	15 kg	3 pcs
4225 003	Treble Hook	3	30 cm	12 kg	3 pcs
4225 005	Treble Hook	5	30 cm	9 kg	3 pcs
4225 008	Treble Hook	8	30 cm	5 kg	3 pcs

Trade Pack 10 Pieces







**Steel Leader**

3 nylon coated leaders in a pack.

Code	Length	BS	Content
2242 004	30 cm	4 kg	3 pcs
2242 006	30 cm	6 kg	3 pcs
2242 009	30 cm	9 kg	3 pcs
2242 012	30 cm	12 kg	3 pcs

Trade Pack 10 Pieces



**Steel Leader**

3 nylon coated leaders in a pack.

Code	Length	BS	Content
2322 004	50 cm	4 kg	3 pcs
2322 006	50 cm	6 kg	3 pcs
2322 009	50 cm	9 kg	3 pcs
2322 012	50 cm	12 kg	3 pcs

Trade Pack 10 Pieces



**Topic Treble Hook, red**

Red, treble hook, round wire, straight tip, barbed.

Code	Hook Size	Content
4439 100	1/0	4 pcs
4439 002	2	5 pcs
4439 004	4	6 pcs
4439 006	6	6 pcs

Trade Pack 10 Pieces



**Topic Treble Hook, nickel**

Nickel, triple hook, round wire, straight trip, barbed.

Code	Hook Size	Content
4440 600	6/0	2 pcs
4440 400	4/0	3 pcs
4440 200	2/0	4 pcs
4440 100	1/0	4 pcs
4440 002	2	5 pcs
4440 004	4	6 pcs
4440 006	6	6 pcs

Trade Pack 10 Pieces



**Topic Treble Hook, gun-smoke**

Smoke coloured, treble hook, round wire, straight tip, barbed.

Code	Hook Size	Content
4441 200	2/0	4 pcs
4441 100	1/0	4 pcs
4441 002	2	5 pcs
4441 004	4	6 pcs
4441 006	6	6 pcs

Trade Pack 10 Pieces



**Trophy Bream hook-to-nylon**

Red, flat wire hook, with straight shank. The hook must stay put each time the rod is lifted, even at a long distance. Whether it is used with feeder or match rod, you can rely on the sharp bream hook.

Code	Hook Size	Leader L. Ø	Hooklength	Content
4381 006	6	0,20 mm	0,70 m	10 pcs
4381 008	8	0,15 mm	0,70 m	10 pcs
4381 010	10	0,15 mm	0,70 m	10 pcs
4381 012	12	0,13 mm	0,70 m	10 pcs
4381 014	14	0,13 mm	0,70 m	10 pcs

Trade Pack 10 Pieces



**Trophy Big Fish hook-to-nylon**

Special hooks on fine leaders, when it comes to using the most delicate baits for relatively powerful fish. Particular suited to a French style of fishing, which also has a presence within the UK angling.

Code	Hook Size	Leader L. Ø	Hooklength	Content
4382 012	12	0,14 mm	0,50 m	10 pcs
4382 014	14	0,14 mm	0,50 m	10 pcs
4382 016	16	0,12 mm	0,50 m	10 pcs
4382 018	18	0,12 mm	0,50 m	10 pcs

Trade Pack 10 Pieces



**Trophy Roach hook-to-nylon**

Light, blue round wire hook with straight shank. Light, sharp hooks are much more likely to result in a catch, particularly when fine fishing for roach as the bait is better presented.

Code	Hook Size	Leader L. Ø	Hooklength	Content
4383 010	10	0,17 mm	0,70 m	10 pcs
4383 012	12	0,15 mm	0,70 m	10 pcs
4383 014	14	0,13 mm	0,70 m	10 pcs
4383 016	16	0,10 mm	0,70 m	10 pcs
4383 018	18	0,10 mm	0,70 m	10 pcs

Trade Pack 10 Pieces



**Trophy Friture hook-to-nylon**

Special small fish hooks for targeting bleak and baitfish. Ideal for pinkies, blood-worm or tiny dough balls.

Code	Hook Size	Leader L. Ø	Hooklength	Content
4384 018	18	0,10 mm	0,20 m	10 pcs
4384 020	20	0,08 mm	0,20 m	10 pcs
4384 022	22	0,06 mm	0,20 m	10 pcs
4384 024	24	0,06 mm	0,20 m	10 pcs
4384 120	20	0,10 mm	0,20 m	10 pcs
4384 122	22	0,08 mm	0,20 m	10 pcs

Trade Pack 10 Pieces





### Trophy Tench hook-to-nylon

Blue, round wire hook with straight shank. It is particularly important, when catching tench, to serve the bait in a subtle and unobtrusive way. Worms, bread and maize hold well on these hooks. The sharp point ensures that the hook holds when the rod is lifted.

Code	Hook Size	Leader L. Ø	Hooklength	Content
4388 006	6	0,25 mm	0,70 m	10 pcs
4388 008	8	0,22 mm	0,70 m	10 pcs
4388 010	10	0,20 mm	0,70 m	10 pcs
4388 012	12	0,18 mm	0,70 m	10 pcs

Trade Pack 10 Pieces



### Trophy Perch hook-to-nylon

Red, sharp, flat wire hook with straight shank and a barb on the shaft. The hook is perfect for fishing for perch with small bait fish and live worms.

Code	Hook Size	Leader L. Ø	Hooklength	Content
4389 004	4	0,28 mm	0,70 m	10 pcs
4389 006	6	0,25 mm	0,70 m	10 pcs
4389 008	8	0,20 mm	0,70 m	10 pcs
4389 010	10	0,18 mm	0,70 m	10 pcs

Trade Pack 10 Pieces



### Trophy Carp hook-to-nylon

Black flat wire hook, with straight shank and exceptionally strong. This is how carp hooks should be. Even when playing particularly large fish, you can rely on the carp hook. It will hold. Ideal hook for fishing with maize, bread, potatoes or boilies.

Code	Hook Size	Leader L. Ø	Hooklength	Content
4387 100	1/0	0,35 mm	0,70 m	10 pcs
4387 002	2	0,35 mm	0,70 m	10 pcs
4387 004	4	0,30 mm	0,70 m	10 pcs
4387 006	6	0,28 mm	0,70 m	10 pcs
4387 008	8	0,25 mm	0,70 m	10 pcs
4387 010	10	0,22 mm	0,70 m	10 pcs

Trade Pack 10 Pieces



### Trophy Zander hook-to-nylon

Ryder double hook made from round wire for reliable zander fishing with bait fish or fish pieces.

Code	Hook Size	Leader L. Ø	Hooklength	Content
4390 002	2	0,35 mm	0,70 m	4 pcs
4390 004	4	0,28 mm	0,70 m	4 pcs
4390 006	6	0,25 mm	0,70 m	4 pcs
4390 008	8	0,20 mm	0,70 m	4 pcs
4390 100	1/0	0,35 mm	0,70 m	4 pcs

Trade Pack 10 Pieces

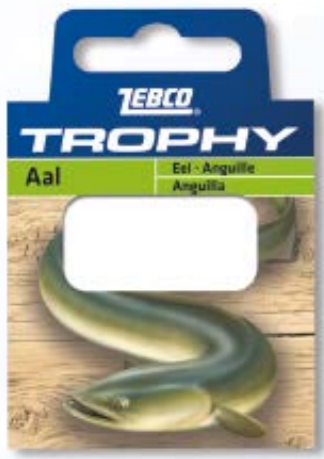

### Trophy Eel hook-to-nylon

The silver flat wire hook with bent hook shank and 2 barbs on the shaft, guarantees a high rate of bites.

Code	Hook Size	Leader L. Ø	Hooklength	Content
4386 002	2	0,35 mm	0,70 m	8 pcs
4386 004	4	0,30 mm	0,70 m	8 pcs
4386 006	6	0,28 mm	0,70 m	8 pcs
4386 008	8	0,25 mm	0,70 m	8 pcs
4386 010	10	0,22 mm	0,70 m	8 pcs

Trade Pack 10 Pieces



### Trophy Allround barbless hook-to-nylon

The leader for every occasion in coarse fishing. Ultra sharp hooks, tied to high quality line – leaders you can rely on at the water's edge. Barbless design.

Code	Hook Size	Leader L. Ø	Hooklength	Content
4378 014	14	0,14 mm	0,70 m	10 pcs
4378 016	16	0,12 mm	0,70 m	10 pcs
4378 018	18	0,12 mm	0,70 m	10 pcs

Trade Pack 10 Pieces



### Trophy Trout hook-to-nylon

This silver flat wire hook is designed for fishing with various different baits and pastes for trout in "put and take" waters.

Code	Hook Size	Leader L. Ø	Hooklength	Content
4385 006	6	0,22 mm	0,70 m	10 pcs
4385 008	8	0,20 mm	0,70 m	10 pcs
4385 010	10	0,17 mm	0,70 m	10 pcs
4385 012	12	0,17 mm	0,70 m	10 pcs
4385 014	14	0,15 mm	0,70 m	10 pcs
4385 106	6	0,18 mm	0,70 m	10 pcs
4385 108	8	0,18 mm	0,70 m	10 pcs
4385 206	6	0,20 mm	0,70 m	10 pcs

Trade Pack 10 Pieces



### Trophy Allround hook-to-nylon

The leader for every occasion in coarse fishing. Ultra-sharp hooks, tied to high quality line – leaders you can rely on at the water's edge.

Code	Hook Size	Leader L. Ø	Hooklength	Content
4379 004	4	0,30 mm	0,70 m	10 pcs
4379 006	6	0,28 mm	0,70 m	10 pcs
4379 008	8	0,25 mm	0,70 m	10 pcs
4379 010	10	0,20 mm	0,70 m	10 pcs
4379 012	12	0,18 mm	0,70 m	10 pcs
4379 014	14	0,16 mm	0,70 m	10 pcs
4379 016	16	0,14 mm	0,70 m	10 pcs

Trade Pack 10 Pieces





### Trophy Worm hook-to-nylon

Bronzed worm hooks with a barb on the shank for a better hold on the bait. Ideal for use with dew worms, lobworms and redworms.

Code	Hook Size	Leader L. Ø	Hooklength	Content
4380 002	2	0,35 mm	0,70 m	10 pcs
4380 004	4	0,30 mm	0,70 m	10 pcs
4380 006	6	0,28 mm	0,70 m	10 pcs
4380 008	8	0,25 mm	0,70 m	10 pcs

Trade Pack 10 Pieces



### Rig Rotation III

Hook Size 2/0, Jig 5,5 cm

Code	Hook Size	Hook	Mainline Ø	Leader L. Ø
4258 002	2/0	2	0,70 mm	0,65 mm
4258 003	3/0	2	0,70 mm	0,65 mm

Trade Pack 10 Pieces



### Codling Rig

With 3 nickel treble hooks, covered with a red/yellow octopus.

Code	Hook Size	Hook	Mainline Ø
3515 000	2/0	3	0,85 mm

Trade Pack 10 Pieces



### Twin Rotation Rig I

Hook Size 3/0, Jig 7.5 cm, Line dia 0.65 mm

Code	Hook Size	Hook	Mainline Ø	Leader L. Ø
4262 001	3/0	2	0,70 mm	0,65 mm
4262 002	1/0	2	0,70 mm	0,65 mm

Trade Pack 10 Pieces



### Twin Rotation Rig III

Hook Size 3/0, Jig 7.5 cm, Line dia 0.65 mm

Code	Hook Size	Hook	Mainline Ø	Leader L. Ø
4262 003	3/0	2	0,70 mm	0,65 mm

Trade Pack 10 Pieces



### Codling Rig

With 3 nickel single hooks, covered with a red/yellow octopus.

Code	Hook Size	Hook	Mainline Ø
3516 000	3/0	3	0,85 mm

Trade Pack 10 Pieces



### Rubber Cod Rig I

The skirt collar on the jighead attracts cod and similar from their hiding places. Hook size 2/0, leader length 70 cm

Code	Length	Hook Size	Hook	Mainline Ø	Leader L. Ø
4265 001	70 cm	2/0	1	0,60 mm	0,45 mm

Trade Pack 10 Pieces



### Twin Rotation Rig IV

Hook Size 3/0, Jig 7.5 cm, Line dia 0.65 mm

Code	Hook Size	Hook	Mainline Ø	Leader L. Ø
4262 004	3/0	2	0,70 mm	0,65 mm

Trade Pack 10 Pieces



### Single Rotation Rig 1

Hook Size 3/0, Jig 7.5 cm, Line dia 0.55 mm

Code	Hook Size	Hook	Mainline Ø	Leader L. Ø
4263 001	3/0	1	0,70 mm	0,65 mm
4263 002	1/0	1	0,70 mm	0,65 mm

Trade Pack 10 Pieces



### Rubber Cod Rig II

The skirt collar on the jighead attracts cod and similar from their hiding places. Hook size 3/0, leader length 70 cm

Code	Length	Hook Size	Hook	Mainline Ø	Leader L. Ø
4265 002	70 cm	3/0	1	0,60 mm	0,45 mm

Trade Pack 10 Pieces



### Rubber Cod Rig III

The skirt collar on the jigheads attract cod and similar from their hiding places. Hook size 2/0, leader length 100 cm

Code	Length	Hook Size	Hook	Mainline Ø	Leader L. Ø
4265 003	100 cm	2/0	2	0,60 mm	0,45 mm

Trade Pack 10 Pieces



### Double Rig 1

Hook Size 3/0 2 Hooks, black/red and red, Line dia 0.70 mm

Code	Hook Size	Hook	Mainline Ø	Leader L. Ø
4264 001	3/0	2	0,70 mm	0,65 mm

Trade Pack 10 Pieces



### Double Rig 2

Hook Size 3/0 2 Hooks, red und black/red, Line dia 0.70 mm

Code	Hook Size	Hook	Mainline Ø	Leader L. Ø
4264 002	3/0	2	0,70 mm	0,65 mm

Trade Pack 10 Pieces



### Rubber Cod Rig IV

The skirt collar on the jigheads attract cod and similar from their hiding places. Hook size 3/0, leader length 100 cm

Code	Length	Hook Size	Hook	Mainline Ø	Leader L. Ø
4265 004	100 cm	3/0	2	0,60 mm	0,45 mm

Trade Pack 10 Pieces



### Flounder and eel system

With 2 side arms and size 2 hook. Rig length approx. 40 cm.

Code	Length	Hook Size	Hook	Mainline Ø	Leader L. Ø
4230 000	100 cm	2	2	0,60 mm	0,40 mm

Trade Pack 10 Pieces





**Flounder system**

With 2 side arms and 2 size 2 flounder hooks.

Code	Length	Hook Size	Hook	Mainline Ø	Leader L. Ø
4237 000	100 cm	2	2	0,60 mm	0,40 mm

Trade Pack 10 Pieces



**Standard Flounder Rig**

Standard Rig for Boatfishing, 3 Hooks

Code	Length	Hook Size	Hook	Mainline Ø	Leader L. Ø
4261 002	120 cm	4	3	0,60 mm	0,40
4261 003	120 cm	6	3	0,60 mm	0,40 mm

Trade Pack 10 Pieces



**Boatfishing Sea Rig**

Special Boatfishing Rig

Code	Length	Hook Size	Hook	Mainline Ø	Leader L. Ø
4260 002	120 cm	4	3	0,60 mm	0,40 mm
4260 003	120 cm	6	3	0,60 mm	0,40 mm

Trade Pack 10 Pieces



**Trophy Whiting Rig 50/50**

Hook size 1, Trophy LOOKy Jig Head 2 g, Curly Tail 5.5 cm, 1 leader diameter 0.50 mm

Code	Length	Colour	Content	Ø	Hook Size	Hook	BS	Weight
4264 010	135 cm / 23 cm	red	1 pcs	0,50 mm / 0,45 mm	1	2	17 / 11 kg	2 g
4264 011	135 cm / 23 cm	black/black-red	1 pcs	0,50 mm / 0,45 mm	1	2	17 / 11 kg	2 g
4264 012	135 cm / 23 cm	red/black-black/red	1 pcs	0,50 mm / 0,45 mm	1	2	17 / 11 kg	2 g
4264 013	135 cm / 23 cm	orange/black	1 pcs	0,50 mm / 0,45 mm	1	2	17 / 11 kg	2 g

Trade Pack 10 Pieces



**Trophy Whiting Rig**

Hook size 1, Trophy LOOKy Jig Head 2 g, Curly Tail 5.5 cm, 1 leader diameter 0.50 mm

Code	Length	Colour	Content	Ø	Hook Size	Hook	BS	Weight
4264 030	135 cm / 23 cm	red	1 pcs	0,50 mm / 0,45 mm	1	2	17 / 11 kg	2 g
4264 031	135 cm / 23 cm	black/black-red	1 pcs	0,50 mm / 0,45 mm	1	2	17 / 11 kg	2 g
4264 032	135 cm / 23 cm	red/black-black/red	1 pcs	0,50 mm / 0,45 mm	1	2	17 / 11 kg	2 g
4264 033	135 cm / 23 cm	orange/black	1 pcs	0,50 mm / 0,45 mm	1	2	17 / 11 kg	2 g

Trade Pack 10 Pieces

**Trophy Cod Rig 50/50**

Hook size 2/0, Trophy LOOKy Jig Head 3.5 g, Curly Tail 7.5 cm, 1 leader diameter 0.50 mm

Code	Length	Colour	Content	Ø	Hook Size	Hook	BS	Weight
4264 020	135 cm / 23 cm	red	1 pcs	0,50 mm / 0,45 mm	1/0	2	17 / 11 kg	3,5 g
4264 021	135 cm / 23 cm	black/black-red	1 pcs	0,50 mm / 0,45 mm	1/0	2	17 / 11 kg	3,5 g
4264 022	135 cm / 23 cm	red/black-black/red	1 pcs	0,50 mm / 0,45 mm	1/0	2	17 / 11 kg	3,5 g
4264 023	135 cm / 23 cm	orange/black	1 pcs	0,50 mm / 0,45 mm	1/0	2	17 / 11 kg	3,5 g

Trade Pack 10 Pieces



**Trophy Cod Rig 40/60**

Hook size 2/0, Trophy LOOKy Jig Head 3.5 g, Curly Tail 7.5 cm, 1 leader diameter 0.50 mm

Code	Length	Colour	Content	Ø	Hook Size	Hook	BS	Weight
4264 040	135 cm / 23 cm	red	1 pcs	0,50 mm / 0,45 mm	1/0	2	17 / 11 kg	3,5 g
4264 041	135 cm / 23 cm	black/black-red	1 pcs	0,50 mm / 0,45 mm	1/0	2	17 / 11 kg	3,5 g
4264 042	135 cm / 23 cm	red/black-black/red	1 pcs	0,50 mm / 0,45 mm	1/0	2	17 / 11 kg	3,5 g
4264 043	135 cm / 23 cm	orange/black	1 pcs	0,50 mm / 0,45 mm	1/0	2	17 / 11 kg	3,5 g

Trade Pack 10 Pieces



**Trophy Pilk Rig 50**

Hook size 2/0, Trophy LOOKy Jig Head 3.5g, Curly Tail 7.5 cm, 1 leader diameter 0.50 mm

Code	Length	Colour	Content	Ø	Hook Size	Hook	BS	Weight
4264 050	85 cm / 23 cm	red	1 pcs	0,50 mm / 0,45 mm	1/0	1	17 / 11 kg	3,5 g
4264 051	85 cm / 23 cm	black	1 pcs	0,50 mm / 0,45 mm	1/0	1	17 / 11 kg	3,5 g
4264 052	85 cm / 23 cm	red/black	1 pcs	0,50 mm / 0,45 mm	1/0	1	17 / 11 kg	3,5 g
4264 053	85 cm / 23 cm	orange	1 pcs	0,50 mm / 0,45 mm	1/0	1	17 / 11 kg	3,5 g

Trade Pack 10 Pieces







**Flatty Boat Rig 1**

Natural bait rig for boat angling and flat-fish: With three hooks, spinner blades and attractive beads and anti-tangle boom, as well as a spare leader for fast replacement via a quick-change bead.

Code	Length	Hook Size	Hook	Mainline Ø	Leader L. Ø
4299 081	1,55 m	1	3	0,60 mm	0,40 mm

Trade Pack 10 Pieces



**Flatty Boat Rig 2**

Natural bait rig for boat angling and flat-fish: With three hooks, spinner blades and attractive beads and anti-tangle boom, as well as a spare leader for fast replacement via a quick-change bead.

Code	Length	Hook Size	Hook	Mainline Ø	Leader L. Ø
4299 082	1,55 m	1	3	0,60 mm	0,40 mm

Trade Pack 10 Pieces



**Flatty Rig 3**

Hook size 2, main line Ø 0.60 mm, hook length 0.40 mm. For boat and surf fishing.

Code	Length	Hook Size	Hook	Mainline Ø	Leader L. Ø
4299 003	120 cm	2	2	0,60 mm	0,40 mm

Trade Pack 10 Pieces



**Flatty Rig 4**

Hook size 2, main line Ø 0.60 mm, hook length 0.40 mm. For boat and surf fishing.

Code	Length	Hook Size	Hook	Mainline Ø	Leader L. Ø
4299 004	120 cm	2	2	0,60 mm	0,40 mm

Trade Pack 10 Pieces



**Cod Boat Rig 1**

Natural bait rig for boat angling for cod: With two hooks, spinner blades and attractive beads and anti-tangle boom.

Code	Length	Hook Size	Hook	Mainline Ø	Leader L. Ø
4299 091	2,00 m	1	2	0,70 mm	0,45 mm

Trade Pack 10 Pieces



**Cod Boat Rig 2**

Natural bait rig for boat angling for cod: With two hooks, spinner blades and attractive beads and anti-tangle boom.

Code	Length	Hook Size	Hook	Mainline Ø	Leader L. Ø
4299 092	2,00 m	1	2	0,70 mm	0,45 mm

Trade Pack 10 Pieces



**Flatty Rig 5**

Hook size 2, main line Ø 0.60 mm, hook length 0.40 mm. For boat and surf fishing.

Code	Length	Hook Size	Hook	Mainline Ø	Leader L. Ø
4299 005	120 cm	2	2	0,60 mm	0,40 mm

Trade Pack 10 Pieces



**Flatty Rig 6**

Hook size 2, main line Ø 0.60 mm, hook length 0.40 mm. For boat and surf fishing.

Code	Length	Hook Size	Hook	Mainline Ø	Leader L. Ø
4299 006	120 cm	2	2	0,60 mm	0,40 mm

Trade Pack 10 Pieces



**Codling Rig**

Basic rig for successful surf angling for codling.

Code	Hook Size
4284 007	2/0

Trade Pack 10 Pieces



**Codling Rig**

Surf rig for codling with hook size 2/0.

Code	Hook Size
4284 008	2/0

Trade Pack 10 Pieces



**Flatty Rig 7**

Hook size 2, main line Ø 0.60 mm, hook length 0.40 mm. For boat and surf fishing.

Code	Length	Hook Size	Hook	Mainline Ø	Leader L. Ø
4299 007	120 cm	2	2	0,60 mm	0,40 mm

Trade Pack 10 Pieces



**Flatty Rig 8**

Hook size 1/0, main line Ø 0.70 mm, hook length 0.40 mm. For boat and surf fishing.

Code	Length	Hook Size	Hook	Mainline Ø	Leader L. Ø
4299 008	120 cm	1/0	2	0,70 mm	0,40 mm

Trade Pack 10 Pieces



**Flatty Rig 1**

Hook size 2, main line Ø 0.60 mm, hook length 0.40 mm. For boat and surf fishing.

Code	Length	Hook Size	Hook	Mainline Ø	Leader L. Ø
4299 001	120 cm	2	2	0,60 mm	0,40 mm

Trade Pack 10 Pieces



**Flatty Rig 2**

Hook size 2, main line Ø 0.60 mm, hook length 0.40 mm. For boat and surf fishing.

Code	Length	Hook Size	Hook	Mainline Ø	Leader L. Ø
4299 002	120 cm	2	2	0,60 mm	0,40 mm

Trade Pack 10 Pieces



**Flatty Rig 9**

Hook size 1/0, main line Ø 0.70 mm, hook length 0.40 mm. For boat and surf fishing.

Code	Length	Hook Size	Hook	Mainline Ø	Leader L. Ø
4299 009	120 cm	1/0	2	0,70 mm	0,40 mm

Trade Pack 10 Pieces



**Flatty Rig 10**

Hook size 1/0, main line Ø 0.70 mm, hook length 0.40 mm. For boat and surf fishing.

Code	Length	Hook Size	Hook	Mainline Ø	Leader L. Ø
4299 010	120 cm	1/0	2	0,70 mm	0,40 mm

Trade Pack 10 Pieces



**Shore Rig No. 1**

Hook Size 1/0, Main Line 0,70mm, Leader 0,40mm, 2 Hooks, bottom clip, Wishbone System, for boat and surf fishing, on a winder

Code	Length	Hook Size	Hook	Mainline Ø	Leader L. Ø
4299 040	82 cm	1/0	2	0,70 mm	0,40 mm

Trade Pack 10 Pieces

**Shore Rig No. 2**

Hook Size 1/0, Main Line 0,70mm, Leader 0,40mm, 2 Hooks, top and center clips, pass through system, for boat and surf fishing, on a winder

Code	Length	Hook Size	Hook	Mainline Ø	Leader L. Ø
4299 041	85 cm	1/0	2	0,70 mm	0,40 mm

Trade Pack 10 Pieces

**Shore Rig No. 3**

Hook Size 1/0, Main Line 0,70mm, Leader 0,40mm, 2 Hooks, top and center clips, short leaders. For boat and surf fishing, on a winder

Code	Length	Hook Size	Hook	Mainline Ø	Leader L. Ø
4299 042	44 cm	1/0	2	0,70 mm	0,40 mm

Trade Pack 10 Pieces

**Shore Rig No. 4**

Hook Size 1/0, Main Line 0,70mm, Leader 0,40mm, 2 Hooks. For boat and surf fishing, on a winder

Code	Length	Hook Size	Hook	Mainline Ø	Leader L. Ø
4299 043	97 cm	1/0	2	0,70 mm	0,40 mm

Trade Pack 10 Pieces

**Shore Rig No. 5**

Hook Size 1/0, Main Line 0,70mm, Leader 0,40mm, 2 Hooks, top and center clips, short leaders. For boat and surf fishing, on a winder

Code	Length	Hook Size	Hook	Mainline Ø	Leader L. Ø
4299 044	86 cm	1/0	2	0,70 mm	0,40 mm

Trade Pack 10 Pieces

**Shore Rig No. 7**

Hook size 1/0+1/0, main line Ø 0.70 mm, leader line Ø 0.50 mm. Rig length 120 cm. 2 hook flapper. For surf fishing.

Code	Length	Hook Size	Mainline Ø	Leader L. Ø
4299 021	85 cm	1/0	0,70 mm	0,50 mm

Trade Pack 10 Pieces

**Shore Rig No. 8**

Hook size 3/0+3/0, main line Ø 0.70 mm, leader line Ø 0.50 mm. Rig length 120 cm. 2 hook clip up. For surf fishing.

Code	Length	Hook Size	Mainline Ø	Leader L. Ø
4299 022	85 cm	3/0	0,70 mm	0,70 mm

Trade Pack 10 Pieces

**Shore Rig No. 9**

Hook size 2/0, main line Ø 0.70 mm, leader line Ø 0.50 mm. Rig length 70 cm. 2 hook pulleye. For surf fishing.

Code	Length	Hook Size	Mainline Ø	Leader L. Ø
4299 023	85 cm	2/0	0,70 mm	0,50 mm

Trade Pack 10 Pieces

**Team KR Surf Rig**

Hook size 1/0, 2 hooks, main line 0.70 mm, hooklengths 0.40 mm. For surf angling.

Code	Length	Hook Size	Hook	Mainline Ø	Leader L. Ø
4283 001	80 cm / 35 cm	1/0	2	0,70 mm	0,40 mm

Trade Pack 10 Pieces

**Team Wishbone S Rig**

Hook size 1/0, 2 hooks, main line 0.70 mm, hooklengths 0.45mm. For surf angling.

Code	Length	Hook Size	Hook	Mainline Ø	Leader L. Ø
4283 002	85 cm / 30 cm	1/0	2	0,70 mm	0,45 mm

Trade Pack 10 Pieces

**Team Wishbone Rig**

Hook size 1/0, 2 hooks, main line 0.70 mm, hooklengths 0.45mm. For surf angling.

Code	Length	Hook Size	Hook	Mainline Ø	Leader L. Ø
4283 003	70 cm / 45 cm	1/0	2	0,70 mm	0,45 mm

Trade Pack 10 Pieces

**Team Storm Rig**

Hook size 1/0, 2 hooks, main line 0.70 mm, hooklengths 0.40mm. For surf angling.

Code	Length	Hook Size	Hook	Mainline Ø	Leader L. Ø
4283 004	90 cm / 40 cm	1/0	2	0,70 mm	0,40 mm

Trade Pack 10 Pieces



### Ultra Distance Surf Rig

Hook size 2/0, main line 0.7 mm, leader 0.55 mm, 1 hook. For boat and surf angling for cod, rays, flatfish or bass. Supplied on a winder.

Code	Length	Hook Size	Hook	Mainline Ø	Leader L. Ø	BS
4238 001	100 cm	2/0	1	0,70 mm	0,55 mm	60 / 30 lbs

Trade Pack 10 Pieces



NEW

### Double Hook Flapper Surf Rig

Hook size 4, main line 0.7 mm, leader 0.55 mm, 2 hooks. For boat and surf angling for cod, whiting, flatfish or bass. Supplied on a winder.

Code	Length	Hook Size	Hook	Mainline Ø	Leader L. Ø	BS
4238 002	120 cm	4	2	0,70 mm	0,55 mm	60 / 30 lbs

Trade Pack 10 Pieces

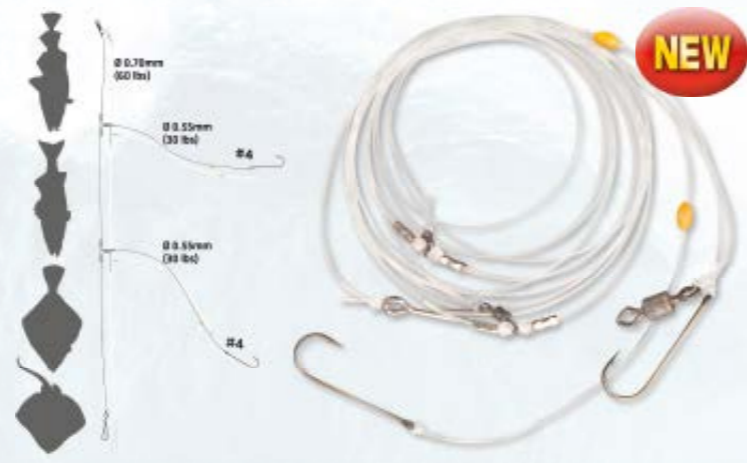

NEW

### Wishbone Surf Rig

Hook size 1, main line 0.7 mm, leader 0.55 mm, 2 hooks. For boat and surf angling for cod, whiting, flatfish or bass. Supplied on a winder.

Code	Length	Hook Size	Hook	Mainline Ø	Leader L. Ø	BS
4238 003	100 cm	1	2	0,70 mm	0,55 mm	60 / 30 lbs

Trade Pack 10 Pieces



NEW

### Pulley Surf Rig

Hook size 1/0, main line 0.7 mm, leader 0.55 mm, 1 hook. For boat and surf angling for cod, whiting, flatfish or bass. Supplied on a winder.

Code	Length	Hook Size	Hook	Mainline Ø	Leader L. Ø	BS
4238 004	110 cm	1/0	2	0,70 mm	0,55 mm	60 / 30 lbs

Trade Pack 10 Pieces



NEW



### Mackerel Rig

4 multi-coloured, silver flies on the rig. Hook size 3/0

Code	Hook Size	Leader L. Ø
3503 000	3/0	0,50

Trade Pack 10 Pieces



### Mackerel Rig

4 red, multi-coloured silver flies on the rig. Hook size 3/0

Code	Hook Size
3504 000	3/0

Trade Pack 10 Pieces



### Mackerel Rig

Line 0,70 mm, Hook size 1

Code	Hook Size
3504 001	1

Trade Pack 10 Pieces



### Mackerel Rig

Line 0,70 mm, Hook size 1/0.

Code	Hook Size	Leader L. Ø
3504 002	1/0	0,70 mm

Trade Pack 10 Pieces



### Mackerel Rig

Line 0,70 mm, Hook size 1/0.

Code	Hook Size	Leader L. Ø
3504 003	1/0	0,70 mm

Trade Pack 10 Pieces



### Mackerel Rig

Line 0,70 mm, Hook size 1/0.

Code	Hook Size	Leader L. Ø
3504 004	1/0	0,70 mm

Trade Pack 10 Pieces



### Mackerel Rig

Line 0,70 mm, Hook size 1/0.

Code	Hook Size
3504 005	1/0

Trade Pack 10 Pieces



### Mackerel Rig

Super paternoster with 4 glitter flies with fish skin wings and phosphorescent beads. Hook size 3/0

Code	Hook Size
3506 000	3/0

Trade Pack 10 Pieces



### Mackerel Rig

With 4 small coloured plastic fish tied to the 3/0 hook with glitter thread

Code	Hook Size
3520 000	3/0

Trade Pack 10 Pieces



### Mackerel Rig

With 5 red plastic fish tied to 2/0 hook

Code	Hook Size	Hook	Leader L. Ø
3441 000	2/0	5	0,50

Trade Pack 10 Pieces



### Mackerel Rig

With 5 small phosphorescent fish and coloured beads. Hook size 2/0

Code	Hook Size	Hook
3442 000	2/0	5

Trade Pack 10 Pieces







**Universal Sea Rig**

Universal sea paternoster with 5 attractive lures. Hook Size 1/0.

Code	Hook Size	Hook
3504 010	1/0	5

Trade Pack 10 Pieces



**Mackerel Rig**

Mackerel paternoster with new type of reflex material. Particularly resilient, hook size 1/0

Code	Hook Size
3503 001	1/0

Trade Pack 10 Pieces



**Mackerel Rig, colored**

With 4 coloured feathers on the rig, hook size 3/0

Code	Hook Size
3510 000	3/0

Trade Pack 10 Pieces



**Circle Hook Mackerel Leader**

Mackerel rig with circle hooks, keeping pull-outs to a minimum. 5 hooks.

Code	Length	Ø	Hook Size	Hook
3455 005	170 cm	0,80 mm / 0,60 mm	1/0	5

Trade Pack 10 Pieces



**Mackerel Leader**

With 6 colour feathers in various designs. Hook size 2.

Code	Hook Size
3504 009	2

Trade Pack 10 Pieces



**Makrel Rig Lumo Hook**

Hook size 1/0, 5 hooks, main line 0.70 mm, hooklengths 0.50mm. For mackerel fishing.

Code	Length	Hook Size	Hook	Mainline Ø	Leader L. Ø
3504 020	150 cm	1/0	5	0,70 mm	0,50 mm

Trade Pack 10 Pieces



**Herring rig with 2 hooks**

The herring tracer that has proven to be most successful over the last for years for herring and whiting.

Code	Hook Size	Hook	Leader L. Ø
3434 002	4	2	0,25 mm
3434 003	8	2	0,25 mm

Trade Pack 10 Pieces



**Herring Rig**

Made from fluorescent fish skin and tied to 5 gold hooks. Exceptionally good for catching herring and whiting.

Code	Hook Size	Hook
3436 000	2	5
3436 001	6	5

Trade Pack 10 Pieces



**Universal Sea Rig**

Universal sea paternoster with 6 attractive lures. Hook Size 1/0.

Code	Hook Size
3504 011	1/0

Trade Pack 10 Pieces



**Herring Rig Lumo Hook 1**

Hook size 4, 6 hooks, main line 0.35mm, hooklengths 0.25mm. For herring fishing.

Code	Length	Hook Size	Hook	Mainline Ø	Leader L. Ø
3446 002	150 cm	4	6	0,35 mm	0,25 mm

Trade Pack 10 Pieces



**Herring Rig**

Made from fluorescent fish skin and tied to 5 gold hooks with luminous beads. The rig that is successful even in dull weather.

Code	Hook Size	Hook
3437 000	2	5
3437 001	6	5

Trade Pack 10 Pieces



**Herring Rig**

The 5 flies made from real fish skin are each tied to the size 6 gold hook

Code	Hook Size	Hook
3446 000	6	5

Trade Pack 10 Pieces



**Herring Rig**

Made from fluorescent fish skin and tied to 6 gold hooks #4 with luminous beads. The rig that is successful even in dull weather.

Code	Hook Size	Hook
3448 001	4	6

Trade Pack 10 Pieces

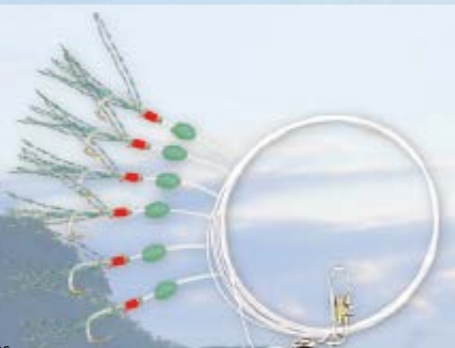

**Herring Rig Lumo Hook 2**

Hook size 4, 6 hooks, main line 0.35mm, hooklengths 0.25mm. For herring fishing.

Code	Length	Hook Size	Hook	Mainline Ø	Leader L. Ø
3446 003	150 cm	4	6	0,35 mm	0,25 mm

Trade Pack 10 Pieces



**Herring Rig**

The herring rig that in recent years has proved to be super efficient at catching herring and whiting. 5 flies made from real fish skin, tied to a gold hook.

Code	Hook Size	Hook
3434 001	4	5

Trade Pack 10 Pieces



**Larves**

Hook Ø Mainline Ø Leader 10 0.30 mm 0.25 mm Length: 1.60 m · Hooks: 6

Code	Length	Hook Size	Hook	Mainline Ø	Leader L. Ø
4291 005	1,60 m	10	6	0,30 mm	0,25 mm

Trade Pack 10 Pieces



**Herring rig silver-red**

Real Fish Skin with fluo beads. 6 hooks.

Code	Hook Size	Mainline Ø
3433 001	10	0,35 mm
3433 101	2	0,35 mm

Trade Pack 10 Pieces





**Herring rig silver-green**

Real Fish Skin. 6 hooks.

Code	Hook Size	Mainline Ø
3433 002	4	
3433 102	10	0,35 mm

Trade Pack 10 Pieces



**Herring Rig, glimmer**

6-hook herring rig with glow-in-the-dark lures. Ideal in gloomy weather. Ø0.40 mm, 6 Hooks #6

Code	Hook Size	Hook
3446 001	6	5

Trade Pack 10 Pieces



**Atlantic Herring Rig**

Special rig for tempting larger herring from their areas of security, particularly popular in Norway. Rig supplied with 5 hooks. Hook size 6.

Code	Hook Size
3504 012	6

Trade Pack 10 Pieces

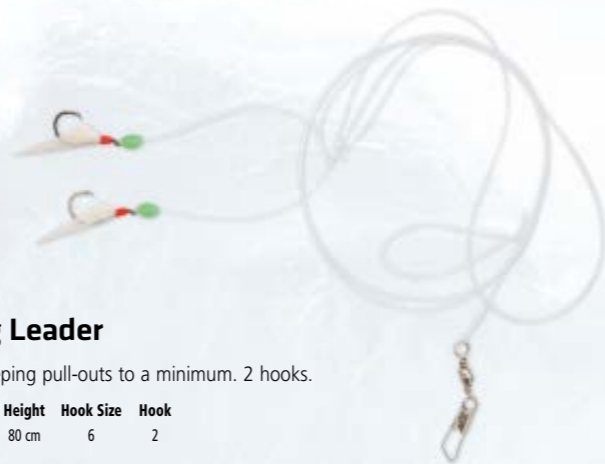

**Circle Hook Herring Leader**

Herring rig with circle hooks, keeping pull-outs to a minimum. 2 hooks.

Code	Colour	Ø	Height	Hook Size	Hook
3454 002	real fish skin	0,40 mm / 0,30 mm	80 cm	6	2

Trade Pack 10 Pieces



**Circle Hook Herring Leader**

Herring rig with circle hooks, keeping pull-outs to a minimum. 5 hooks.

Code	Colour	Ø	Height	Hook Size	Hook
3454 005	real fish skin	0,40 mm / 0,30 mm	100 cm	6	5

Trade Pack 10 Pieces

**Holografix Herring Trace**

When it comes to herring fishing, the right leader is crucial. This explains why some anglers catch significantly more fish than others. The Holografix leader combines all of the essential features to ensure that your catch bucket fills up quickly. Sharp, robust hooks combined with genuine fish skin and added holographic strands make this the perfect leader.

Code	Model	Length	Colour	Content	Hook Size	Hook	Mainline Ø	Leader L. Ø	BS
3449 001	Natural Fish Skin	1,40 m	Natural Fish Skin	1 pcs	10	5	0,30 mm	0,25 mm	5 kg
3449 004	Natural Fish Skin	1,00 m	Natural Fish Skin	1 pcs	10	2	0,30 mm	0,25 mm	5 kg

Trade Pack 10 Pieces



NEW

**Holografix Herring Trace**

When it comes to herring fishing, the right leader is crucial. This explains why some anglers catch significantly more fish than others. The Holografix leader combines all of the essential features to ensure that your catch bucket fills up quickly. Sharp, robust hooks combined with genuine fish skin and added holographic strands make this the perfect leader.

Code	Model	Length	Colour	Content	Hook Size	Hook	Mainline Ø	Leader L. Ø	BS
3449 002	Red Fish Skin	1,40 m	Red Fish Skin	1 pcs	10	5	0,30 mm	0,25 mm	5 kg
3449 005	Red Fish Skin	1,00 m	Red Fish Skin	1 pcs	10	2	0,30 mm	0,25 mm	5 kg

Trade Pack 10 Pieces



NEW

**Holografix Herring Trace**

When it comes to herring fishing, the right leader is crucial. This explains why some anglers catch significantly more fish than others. The Holografix leader combines all of the essential features to ensure that your catch bucket fills up quickly. Sharp, robust hooks combined with genuine fish skin and added holographic strands make this the perfect leader.

Code	Model	Length	Colour	Content	Hook Size	Hook	Mainline Ø	Leader L. Ø	BS
3449 003	Yellow Fish Skin	1,40 m	Yellow Fish Skin	1 pcs	10	5	0,30 mm	0,25 mm	5 kg
3449 006	Yellow Fish Skin	1,00 m	Yellow Fish Skin	1 pcs	10	2	0,30 mm	0,25 mm	5 kg

Trade Pack 10 Pieces

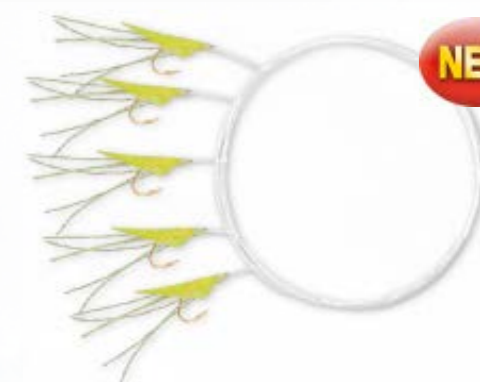

NEW







**Luminous beads oval, fluorescent**

20 pieces per pack.

Code	Length	Content
3169 005	5 mm	20 pcs
3169 008	8 mm	20 pcs
3169 015	11 mm	20 pcs

Trade Pack 10 Pieces



**Soft fluorescent bead**

Code	Content	Width	Height
3169 020	10 pcs	4 mm	5 mm
3169 021	10 pcs	6 mm	8 mm
3169 022	10 pcs	7 mm	10 mm
3169 023	10 pcs	8 mm	12 mm

Trade Pack 10 Pieces



**Casting Shield**

Code	Colour	Content
4286 003	black	5 pcs

Trade Pack 10 Pieces



**Cross-line swivel, fluo beads**

Code	Length	Content	Size
6139 001	16 mm / 14 mm	3 pcs	small
6139 002	20 mm / 15 mm	3 pcs	large

Trade Pack 10 Pieces



**Bait elastic, medium**

Code	Length	Ø
6004 010	200 m	0,20 mm
6004 011	200 m	0,30 mm

Trade Pack 10 Pieces



**Bait Clip**

Variable for different weights, can be changed quickly and safely and the additional hook releases the hook after casting.

Code	Length	Colour	Content
4286 022	15 mm	silver	6 pcs

Trade Pack 10 Pieces



**Casting Shield**

Code	Colour	Content
4286 004	transparent	5 pcs

Trade Pack 10 Pieces



**Bait Clip**

Code	Content
4286 005	10 pcs

Trade Pack 10 Pieces



**Cascade Swivel**

Code	Content	BS
6188 001	10 pcs	13 kg

Trade Pack 10 Pieces



**Mini crimps**

High-performance pinch sleeves in mini-format for use with monofilament. We put much thought into the choice of material. This is a corrosion-resistant material, which is so soft that the crimped monofilament is not damaged but holds absolutely firmly.

Code	Length	Colour	Content
6411 108	6 mm	black nickel	100 pcs

Trade Pack 10 Pieces



**Bait Clip**

Code	Content	BS
6188 002	10 pcs	13 kg

Trade Pack 10 Pieces



**Bead assortment**

Code	Content	Ø
3169 998	100 pcs	2,00 mm / 3,00 mm

Trade Pack 10 Pieces



**Luminous bead assortment**

Code	Content	Ø
3169 999	100 pcs	2,00 mm / 3,00 mm

Trade Pack 10 Pieces



**Casting Clip**

Innovative surf clip. Fixed to the line via a crimped sleeve in the position initially selected.

Code	Content
4286 002	10 pcs

Trade Pack 10 Pieces



**Link Clip**

The quickest and most reliable clip for artificial bait and rigs. 10 pieces per pack.

Code	Content
4286 021	10 pcs

Trade Pack 10 Pieces



**Rig Clip**

100% guaranteed hook release after casting. 10 pieces per pack.

Code	Content
4286 020	10 pcs

Trade Pack 10 Pieces



**Side arm**

In metal, 5 pieces per pack with 10 glass pearls.

Code	Length	Content
4278 007	5 cm	5 pcs
4278 012	12 cm	5 pcs

Trade Pack 10 Pieces



**Rice Beads**

Attractive pearl-coloured beads for flatfish rigs - essential for attracting flounder and plaice to your bait.

Code	Length	Colour	Content	Ø
6627 001	6 mm	mother of pearl	100 pcs	3 mm / 1 mm
6627 002	6 mm	pearl red	100 pcs	3 mm / 1 mm
6627 003	6 mm	pearl yellow	100 pcs	3 mm / 1 mm

Trade Pack 10 Pieces



kompletný cenník na [www.SPORTS.sk](http://www.SPORTS.sk), výhradný distribútor pre SR: SPORTS s.r.o.





black-metallic



red/black metallic



green/rainbow glitter



purple/rainbow glitter



blue/rainbow glitter



yellow/rainbow glitter

\*Extra short for use with flounder teasers.



### Flatty Teaser, lead free

Lead-free flounder teaser. An indispensable attractor for rigging above the hook when hunting flatfish. The lead-free design is also permitted on Scandinavian trips.

Weight	Content	black-metallic	red/black metallic	green/rainbow glitter	purple/rainbow glitter	blue/rainbow glitter	yellow/rainbow glitter
20 g	1 pcs	3074 201	3074 202	3074 203	3074 204	3074 205	3074 206
40 g	1 pcs	3074 301	3074 302	3074 303	3074 304	3074 305	3074 306
60 g	1 pcs	3074 401	3074 402	3074 403	3074 404	3074 405	3074 406
80 g	1 pcs	3074 501	3074 502	3074 503	3074 504	3074 505	3074 506

Trade Pack 10 Pieces



orange/yellow



pearl white/pink



black/gold



white/glow in the dark



orange/glow in the dark



yellow/glow in the dark



### Flatty Teaser Inline, lead free

Lead-free flounder teaser. An indispensable attractor for rigging above the hook when hunting flatfish. The lead-free design is also permitted on Scandinavian trips. For Inline Rigs.

Weight	Leader L. Ø	orange/yellow	pearl white/pink	black/gold	white/glow in the dark	orange/glow in the dark	yellow/glow in the dark
30 g	0,80 mm	3088 030	3088 031	3088 032	3088 033	3088 034	3088 035
50 g	0,80 mm	3088 050	3088 051	3088 052	3088 053	3088 054	3088 055
80 g	0,80 mm	3088 080	3088 081	3088 082	3088 083	3088 084	3088 085

Trade Pack 10 Pieces







**Flatty Teaser Rig Leadfree 1**

Flat-fish rig with lead-free flatty teaser and a snood plus a trailing leader, both with spinner blades and attractive beads.

Code	Length	Colour	Hook Size	Weight
4299 051	1,00 m	green	1	40 g
4299 052	1,00 m	green	1	60 g
4299 053	1,00 m	green	1	80 g

Trade Pack 10 Pieces



**Flatty Teaser Rig Leadfree 2**

Flat-fish rig with lead-free flatty teaser and a snood plus a trailing leader, both with spinner blades and attractive beads.

Code	Length	Colour	Hook Size	Weight
4299 061	1,00 m	yellow	1	40 g
4299 062	1,00 m	yellow	1	60 g
4299 063	1,00 m	yellow	1	80 g

Trade Pack 10 Pieces



**Flatty Leader 2**

Flatfish leader with three striking, buoyant red beads.

Code	Length	Content	Hook Size	Hook	Mainline Ø
4299 031	35 cm	2 pcs	1	1	0,40 mm

Trade Pack 10 Pieces



**Flatty Leader 3**

Refined flatfish leader with a combination of a large spinner blade and attractive beads.

Code	Length	Content	Hook Size	Hook	Mainline Ø
4299 032	35 cm	2 pcs	1	1	0,40 mm

Trade Pack 10 Pieces



**Flatty Teaser Rig Leadfree 3**

Flat-fish rig with lead-free flatty teaser and a snood plus a trailing leader, both with spinner blades and attractive beads.

Code	Length	Colour	Hook Size	Weight
4299 071	1,00 m	red/black	1	40 g
4299 072	1,00 m	red/black	1	60 g
4299 073	1,00 m	red/black	1	80 g

Trade Pack 10 Pieces



**Flatty Leader 1**

Simple flatfish leader with spinner blade.

Code	Length	Content	Hook Size	Hook	Mainline Ø
4299 030	35 cm	2 pcs	1	1	0,40 mm

Trade Pack 10 Pieces

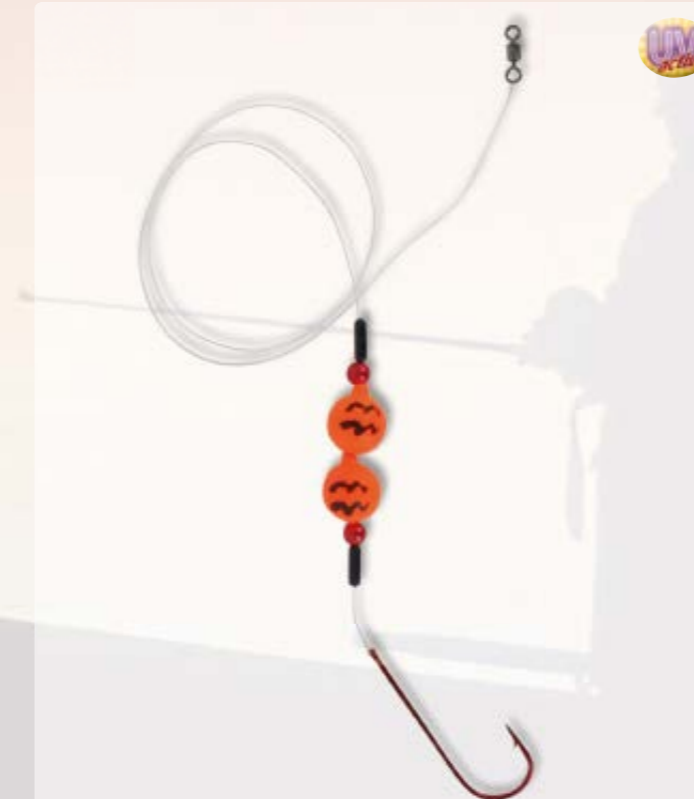

**Flatty Leader 4**

Flatfish leader with two striking, red attractive beads.

Code	Length	Content	Hook Size	Hook	Mainline Ø
4299 033	35 cm	2 pcs	1	1	0,40 mm

Trade Pack 10 Pieces



**Flatty Leader 5**

Refined flatfish leader with a combination of a small spinner blade and two attractive beads.

Code	Length	Content	Hook Size	Hook	Mainline Ø
4299 034	35 cm	2 pcs	1	1	0,40 mm

Trade Pack 10 Pieces





### Flatty Teaser Inline Rig

Special flatfish rig with the familiar "Inline Teaser" that communicates even the finest of bites to the angler.

Length	Weight	Content	Hook Size	Hook	Mainline Ø	Leader L. Ø	orange/yellow	pearl white/pink	black/gold	white/glow	orange/glow	yellow/glow
90 cm, 25 cm	30 g	1 pcs	1	2	0,70 mm	0,40 mm	4228 030	4228 031	4228 032	4228 033	4228 034	4228 035
90 cm, 25 cm	50 g	1 pcs	1	2	0,70 mm	0,40 mm	4228 050	4228 051	4228 052	4228 053	4228 054	4228 055
90 cm, 25 cm	80 g	1 pcs	1	2	0,70 mm	0,40 mm	4228 080	4228 081	4228 082	4228 083	4228 084	4228 085

Trade Pack 10 Pieces



### Flatty Wishbone Rig

Hook size 1, main line 0.45 mm, leader 0.45 mm, 2 hooks. For boat and surf angling for cod or flatfish. Supplied on a round winder.

Length	Content	Hook Size	Hook	Mainline Ø	Leader L. Ø	BS	white/pink	yellow/orange	white/yellow	glow-orange	glow-white	glow-yellow
0,50 m	1 pcs	1	2	0,45 mm	0,45 mm	14	4255 001	4255 002	4255 003	4255 004	4255 005	4255 006

Trade Pack 10 Pieces

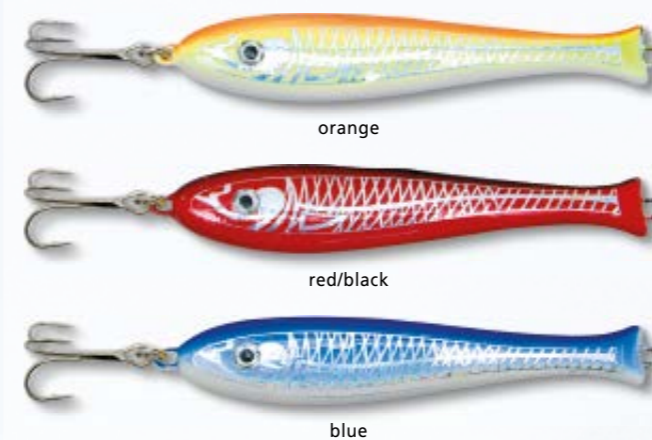

### Stomp Pilker

A particularly lively, thrashing pilker. When cod will only be tempted by an attractive, eye catching lure, the Stomp Pilker makes the difference. The design is the most attractive seen on the market for years, especially for use on the coast.

Weight	orange	red/black	blue
60 g	3471 060	3471 061	3471 062
75 g	3471 075	3471 076	3471 077
100 g	3471 100	3471 101	3471 102
125 g	3471 125	3471 126	3471 127

Trade Pack 5 Pieces



### Ruby Head Pirk

Pirker design with offset gill area. The shift in balance creates innovative and highly attractive retrieve characteristics. Available in the three most attractive designs.

Weight	Hook Size	orange	black/silver	black/red
75 g	1	3474 075	3474 076	3474 077
100 g	1/0	3474 100	3474 101	3474 102
125 g	1/0	3474 125	3474 126	3474 127
150 g	2/0	3474 150	3474 151	3474 152
200 g	2/0	3474 200	3474 201	3474 202

Trade Pack 5 Pieces

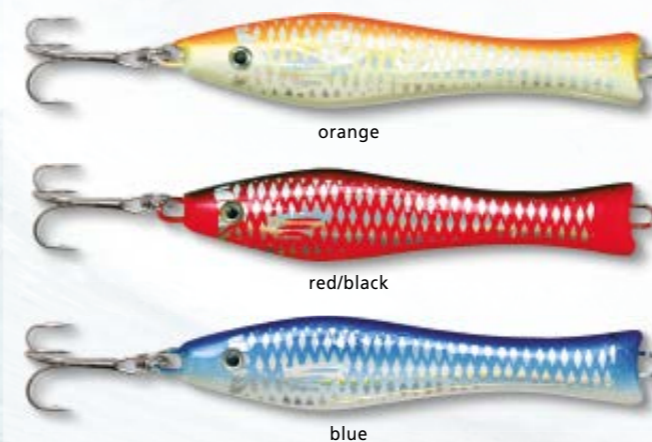

### Fat Head Pilker

When speed to get to deep water is the objective, the Fat Head Pilker comes into its own. With the urgency of decline achieved quicker, this should improve your catch rate. An ideal pilker, intended for jigging with upstream jigs.

Weight	orange	red/black	blue
75 g	3470 075	3470 076	3470 077
100 g	3470 100	3470 101	3470 102
125 g	3470 125	3470 126	3470 127

Trade Pack 5 Pieces



### Lead Free Fat Head

Popular pilker design now also in lead-free version.

Weight	red/black	blue/silver	orange/silver	pink/white
75 g	3482 075	3482 076	3482 077	3482 078
100 g	3482 101	3482 102	3482 103	3482 104
125 g	3482 125	3482 126	3482 127	3482 128
150 g	3482 151	3482 152	3482 153	3482 154
200 g	3482 201	3482 202	3482 203	3482 204
300 g	3482 301	3482 302	3482 303	3482 304

Trade Pack 5 Pieces





**Curly Tail**

The Curly Tail is one of the most popular and successful lures when it comes to jigging for powerful sea predators. The soft lure can be fished with or without the bobbles on the tail. The different movement patterns significantly increase the attraction to cod and co. With its intricate design, the Curly Tail is extremely enticing. The hook channel in the twister also enables rapid and precise changes of lure. The twister is available in 2 sizes and 8 different designs. The Curly Tail goes perfectly with the Trophy LOOky Jig Head – a combination no fish can resist.

Length	Weight	Contents	Fred fire-red	black Betty	Purple Pebbles	flo'n stones	dino diamond	yabba dabba doo	Bamm Bamm	Barney
6 cm	1,5 g	5 pcs	3263 001	3263 002	3263 003	3263 004	3263 005	3263 006	3263 007	3263 008
6 cm	1,5 g	100 pcs	3263 501			3263 504			3263 507	
8 cm	3,5 g	5 pcs	3263 101	3263 102	3263 103	3263 104	3263 105	3263 106	3263 107	3263 108
8 cm	3,5 g	100 pcs	3263 601			3263 604			3263 607	



perch



roach

**Balance Jig**

Essential lure type for perch angling. The lure is fished vertically, making it ideal for winter angling through an ice hole.

Length	Weight	perch	roach
40 mm	12 g	3102 001	3102 002

Trade Pack 5 Pieces



**Twister Set**

60-piece Twister set.

Code	Content
3185 999	60 items

Trade Pack 5 Pieces



yellow

red



**Trophy LOOky Jig Head**

A refined jig head design, specially developed for jigging for sea predators. The notches in the material around the eyes and mouth guarantee tantalising presentation of the twister. The jig head sensibly covers the market in an optimal weight range from 2 g and 3.5 g. The hooks are incredibly sharp and hard - pull-outs are a thing of the past. The twister is mounted via two cone-shaped rings, enabling extremely quick lure changes without affecting the secure hold of the soft lure. The LOOky Jig Head perfectly complements the Curly Tail. A combination that will drive sea predators wild.

Weight	Content	Hook Size	yellow	red
2 g	4 pcs	1/0	3112 001	3112 002
3,5 g	4 pcs	3/0	3112 101	3112 102

Trade Pack 5 Pieces



**Slayer Spoon**

The silver "banana": The bends of this long casting spoon create ultra agile retrieve motions. The sleek, silver design is universally successful whether for sea trout, sea salmon or cod, all will fall victim to the Slayer.

Code	Length	Weight
3083 001	10,0 cm	28 g
3083 002	11,5 cm	40 g

Trade Pack 10 Pieces



**Nordic Dancer leadfree**

Value for money, lead free pirker supplied from the factory with side mounted mak. With octopus above the treble, with fantastic catch rate guaranteed.

Code	Weight
3473 300	300 g
3473 400	400 g
3473 500	500 g
3473 600	600 g

Trade Pack 5 Pieces



**Chromat Pilker leadfree**

A tried and trusted lure and now environmentally friendly with no lead! A must for the tackle box when heading to Norway.

Code	Weight
3472 075	75 g
3472 100	100 g
3472 125	125 g
3472 150	150 g
3472 200	200 g
3472 250	250 g
3472 300	300 g
3472 400	400 g
3472 500	500 g
3472 600	600 g

Trade Pack 5 Pieces



**Reef-Master**

The name says everything about this lure - it is probably the original shape of all lures and particularly suitable for fishing in deep water with a strong current.

Code	Colour	Weight
3478 300	chrome	300 g
3478 400	chrome	400 g
3478 500	chrome	500 g
3478 600	chrome	600 g

Trade Pack 5 Pieces





**NEW**

**Cod Rig**

1 Makk, main line 0.8 mm, leader 0.8 mm 40 kg. For boat fishing for cod, coalfish or pollock for rigging above pirkers or soft lures. Supplied on a round winder.

Code	Length	Colour	Content	Hook Size	Mainline Ø	BS
4770 001	100 cm	black	1 pcs	6/0	0,80 mm	40 kg
4770 002	100 cm	self-luminous	1 pcs	6/0	0,80 mm	40 kg
4770 003	100 cm	red	1 pcs	6/0	0,80 mm	40 kg
4770 101	100 cm	black	1 pcs	8/0	1,00 mm	50 kg
4770 102	100 cm	self-luminous	1 pcs	8/0	1,00 mm	50 kg
4770 103	100 cm	red	1 pcs	8/0	1,00 mm	50 kg

Trade Pack 10 Pieces



**NEW**

**Coalfish Rig**

3 cod spoons, main line 0.8 mm, leader 0.80 mm 40 kg. For boat fishing for cod, coalfish or pollock for rigging above pirkers or soft lures. Supplied on a round winder.

Code	Length	Colour	Content	Hook Size	Mainline Ø	BS
4771 001	150 cm	red/silver	1 pcs	6/0	0,80 mm	40 kg

Trade Pack 10 Pieces



**NEW**

**Ling Rig**

2 double-hook rigs, each comprising two single hooks in sizes 10/0 and 7/0 for a fish strip or whole baitfish, main line 1.2 mm, leader 1.2 mm 65 kg. For boat fishing for ling, lumpfish and large cod. Supplied on a round winder.

Code	Length	Colour	Content	Hook Size	Mainline Ø	BS
4771 004	420 cm	self-luminous	1 pcs	7/0/10/0	1,20 mm	65 kg

Trade Pack 10 Pieces



**NEW**

**Catfish Rig**

2 size 8/0 single hooks with rubber octopus for a fish strip, main line 1 mm, leader 1 mm 50 kg. For boat fishing for wolffish. Supplied on a round winder.

Code	Length	Colour	Content	Hook Size	Mainline Ø	BS
4771 005	115 cm	self-luminous	1 pcs	8/0	1,00 mm	50 kg

Trade Pack 10 Pieces



**NEW**

**Haddock Rig**

2 size 7/0 hooks for fish strips or shrimp, luminous spoon that comes on automatically upon contact with the water, main line 0.8 mm, leader 0.8 mm 40 kg. For boat fishing for haddock, cod or coalfish. Supplied on a round winder.

Code	Length	Content	Hook Size	Mainline Ø	BS
4771 002	190 cm	1 pcs	7/0	0,80 mm	40 kg

Trade Pack 10 Pieces



**NEW**

**Halibut Rig**

Double-hook rig comprising a size 10/0 single hook and size 4/0 treble for whole baitfish, main line 1.2 mm, leader 1.2 mm 65 kg. For boat fishing for halibut and large cod. Supplied on a round winder.

Code	Length	Content	Hook Size	Mainline Ø	BS
4771 003	210 cm	1 pcs	10/0/4/0	1,20 mm	65 kg

Trade Pack 10 Pieces



**NEW**

**Lumpfish Rig**

2 double-hook rigs, each comprising a size 7/0 single hook and size 2/0 treble for a fish strip or whole baitfish, main line 1.2 mm, leader 1.2 mm 65 kg. For boat fishing for lumpfish, ling and large cod. Supplied on a round winder.

Code	Length	Colour	Content	Hook Size	Mainline Ø	BS
4771 006	280 cm	self-luminous	1 pcs	7/0/2/0	1,20 mm	65 kg

Trade Pack 10 Pieces



**NEW**

**Hake Rig**

3 single hook rigs in size 10/0 for a fish strip. Main line 1 mm, leader 1 mm 50 kg. For boat fishing for hake. Supplied on a round winder.

Code	Length	Colour	Content	Hook Size	Mainline Ø	BS
4771 007	330 cm	self-luminous	1 pcs	10/0	1,00 mm	50 kg

Trade Pack 10 Pieces





**Redfish Rig**

5 size 7/0 single hook rigs with phosphorescent tube for a fish strip or a shrimp, main line 1 mm, leader 1 mm 50 kg. For boat fishing for redfish. Supplied on a round winder.

Code	Length	Colour	Content	Hook Size	Mainline Ø	BS
4771 008	500 cm	self-luminous	1 pcs	7/0	1,00 mm	50 kg

Trade Pack 10 Pieces



**Sea Spin Leader**

Leader length of 1 m with high-quality connector for rigging above the soft lure or pirker. 2 supplied on a round winder

Code	Length	Content	Mainline Ø	BS
4772 040	100 cm	2 pcs	0,80 mm	40 kg
4772 050	100 cm	2 pcs	1,00 mm	50 kg
4772 065	100 cm	2 pcs	1,20 mm	65 kg

Trade Pack 10 Pieces



**Aragon Squid Lure**

When the squid are lying a little deeper, the Aragon Squid Lure comes into its own. The weight-head mouth means the lure can be offered enticingly at lower depths.

Length	Weight	orange	red	pink tiger	deep purple	coral	sand eel
11 cm	14 g	3417 001	3417 002	3417 003	3417 004	3417 005	3417 006
13 cm	18 g	3417 101	3417 102	3417 103	3417 104	3417 105	3417 106
15 cm	25 g	3417 201	3417 202	3417 203	3417 204	3417 205	3417 206

Trade Pack 10 Pieces



**Atoll Squid Lure**

Innovative squid lure with a soft, elastic body. Arouses less suspicion when the tentacles wrap around it. This means the squid takes a firmer grip and, as a result, hangs on better.

Length	Weight	glow	striped mullet	clipfish	anchovis	blue fish
11 cm	30 g	3419 001	3419 002	3419 003	3419 004	3419 005
13 cm	40 g	3419 101	3419 102	3419 103	3419 104	3419 105

Trade Pack 10 Pieces



kompletný cenník na [www.SPORTS.sk](http://www.SPORTS.sk), výhradný distribútor pre SR: SPORTS s.r.o.





**Jekyll Squid Lure**

Irresistible squid lure. Fabric-coated body in striking colour patterns, which proved highly popular with squid in testing. With needle-sharp hook collars for optimal catch results.

Length	Weight	pink	orange	olive green	black	blue	white	chartreuse
6 cm	5 g	3412 001	3412 002	3412 003	3412 004	3412 005	3412 006	3412 007
10 cm	11 g			3412 103	3412 104	3412 105	3412 106	3412 107
11,5 cm	15 g			3412 203	3412 204			

Trade Pack 10 Pieces



silver

**Laxus Blinker**

The professional compact spoon bait for long casting. It flies very well and runs in a whirling and spinning motion due to the diagonal slits cut into the sides, making it particularly effective for perch. The Laxus is available from 2.5 to 28 grams.

Length	Weight	silver
3,5 cm	2,5 g	3394 001
4 cm	3,5 g	3394 002
4,5 cm	7 g	3394 003
5 cm	10 g	3394 004
5,5 cm	14 g	3394 005
6,5 cm	21 g	3394 006
7 cm	28 g	3394 007

Trade Pack 10 Pieces



red/black

purple sand eel

sardine

sand eel

**Slim Eel Jim**

Ultra-slim sea trout lure with outstanding casting properties. Imitates young sand eels perfectly.

Length	Weight	red/black	purple sand eel	sardine	sand eel
9 cm	18 g	3303 301	3303 302	3303 303	3303 304
10,5 cm	25 g	3303 501	3303 502	3303 503	3303 504

Trade Pack 10 Pieces



**Silver Dancer Set**

The perfect spoon bait set for sea trout angling on the coast. We have now introduced this tried and tested shape in the best premium catch designs.

Code	Content	Weight
3082 999	5 pcs	18 g

Trade Pack 5 Pieces



**Seatrout Lifter Rig with Fly**

Practical sea trout lifter rig with matching fly in the most popular tying types for successful in-shore fishing. Tied on to high-quality, fluorocarbon monofilament.

Code	Length	Content	Mainline Ø
4200 001	60 cm	1 pcs	0,35 mm

Trade Pack 10 Pieces



**Seatrout Lifter Rig with Fly**

Practical sea trout lifter rig with matching fly in the most popular tying types for successful in-shore fishing. Tied on to high-quality, fluorocarbon monofilament.

Code	Length	Content	Mainline Ø
4200 002	60 cm	1 pcs	0,35 mm

Trade Pack 10 Pieces



**Seatrout Lifter Rig with Fly**

Practical sea trout lifter rig with matching fly in the most popular tying types for successful in-shore fishing. Tied on to high-quality, fluorocarbon monofilament.

Code	Length	Content	Mainline Ø
4200 003	60 cm	1 pcs	0,35 mm

Trade Pack 10 Pieces





natural

black/gold/red

blue/silver



motor oil

pink/silver/white

green/silver/yellow



**Bulben**

The new Zebco Bulben inline spoons prove that forward-looking developments such as "lead-free" and "inline line guides" do not have to be unattractive! The inline guide is protected internally with a Teflon tube, allowing the spoon to be fished even with thin leaders without the rotating spoon damaging the leader. The lure is also supplied with a ready-made fluorocarbon leader and a high-quality carbon steel treble in a suitable size. The target species of this lure is, of course, the sea trout but it is also excellently suited to modern tuna, bass and even freshwater asp fishing.

Weight	Hook Size	Leader L. Ø	natural	black/gold/red	blue/silver	motor oil	pink/silver/white	green/silver/yellow
16 g	6	0,24 mm	3370 001	3370 002	3370 003	3370 004	3370 005	3370 006
24 g	4	0,24 mm	3370 101	3370 102	3370 103	3370 104	3370 105	3370 106
30 g	4	0,28 mm	3370 201	3370 202	3370 203	3370 204	3370 205	3370 206

Trade Pack 5 Pieces



black/gold

blue/chartreuse

copper



gold/green

black shiner

rainbow trout



white/orange

king salmon

red/black



yellow/black



**Impact Spoon**

Classic shore spinner with a slim body yet curved design. This enables the angler to achieve high casting distances on the one hand and extremely interesting retrieves on the other.

Length	Weight	black/gold	blue/chartreuse	copper	gold/green	black shiner	rainbow trout	white/orange	king salmon	red/black	yellow/black
9,5 cm	16 g	3391 001	3391 002	3391 003	3391 004	3391 005	3391 006	3391 007	3391 008	3391 009	3391 010
11 cm	25 g	3391 101	3391 102	3391 103	3391 104	3391 105	3391 106	3391 107	3391 108	3391 109	3391 110

Trade Pack 10 Pieces





gold

silver

copper

perch



red/silver



**Classic Spoon**

The classic spoon bait! Always effective and available in three standard colour variations. From the 6 gram light stream spoon bait for trout through to the heavy pike spoon for deep river section up to 45 grams.

Length	Weight	gold	silver	copper	perch	red/silver
5,5 cm	6 g	3390 006	3390 106	3390 206		
8 cm	16 g	3390 016	3390 116	3390 216	3390 316	3390 416
9,5 cm	22 g	3390 022	3390 122	3390 222	3390 322	3390 422
10 cm	30 g	3390 030	3390 130	3390 230	3390 330	3390 430
12 cm	45 g	3390 045	3390 145	3390 245	3390 345	3390 445

Trade Pack 10 Pieces



silver/red

green/silver

black/silver

red/chartreuse



**Weedy**

When cabbage and water lilies are in abundance, the Weedy predator spoon comes into its own. The tried and tested design has been combined with two wire deflectors, which reliably prevent snagging in the cabbage. Now you can hunt pike where normal lures fear to tread.

Length	Weight	silver/red	green/silver	black/silver	red/chartreuse
7 cm	16 g	3389 016	3389 116	3389 216	3389 316

Trade Pack 10 Pieces



silver

black/silver

silver/red/black

trout



silver/red



**River**

The current spinner with special reflective foil and printed with a totally catch tested design. River not only looks good but also ensures excellent catches – you can rely on it.

Length	Weight	silver	black/silver	silver/red/black	trout	silver/red
4,5 cm	5 g	3073 001	3073 101	3073 201	3073 301	3073 401
5,0 cm	7 g	3073 002	3073 102	3073 202		3073 402
5,5 cm	9 g	3073 003	3073 103	3073 203	3073 303	3073 403
5,5 cm	13 g	3073 004	3073 104	3073 204	3073 304	
6,0 cm	15 g	3073 005	3073 105	3073 205	3073 305	3073 405

Trade Pack 10 Pieces



gold/green



black



yellow

**Double Breaker**

A top class tandem spinner. The two spinners, arranged one behind the other are perfectly matched for size and enlarge the silhouette of the bait. Fantastic for pike.

Length	Weight	gold/green	black	yellow
6,5 cm	12 g	3078 001	3078 101	3078 201
9,0 cm	20 g	3078 002	3078 102	3078 202

Trade Pack 10 Pieces



black/silver



silver

**River-Sounder**

Acoustic support to the effective reflective foils. No predatory fish lets this spinner through its territory unchallenged. Particularly with the low weights, large hunters are outwitted as they hear the acoustic signals but are not scared off by them.

Length	Weight	black/silver	silver
5,0 cm	4 g	3075 001	3075 101
5,5 cm	7 g	3075 002	3075 102
5,5 cm	10 g	3075 003	3075 103
6,0 cm	15 g	3075 004	3075 104

Trade Pack 10 Pieces





**Prey Runner**

A spinner with a classic blade shape and three natural designs with holographic highlighting. So enticing that tremendous catches are possible even in heavily fished waters. Also very special: the excellent price performance ratio.

Length	Weight	perch	roach	trout
4,0 cm	3 g	3070 001	3070 101	3070 201
4,5 cm	3 g	3070 002	3070 102	3070 202
4,5 cm	4 g	3070 003	3070 103	3070 203
5,0 cm	6 g	3070 004	3070 104	3070 204
5,0 cm	9 g	3070 005	3070 105	3070 205

Trade Pack 10 Pieces



**Twin-Runner**

The massive attack on the lateral line of predator fish. Ideal where visual conditions are poor and the fish predator is thus reduced to sensing its quarry.

Length	Weight	glow	red/yellow	black/red
7,0 cm	13 g	3076 004	3076 104	3076 204
7,5 cm	18 g	3076 005	3076 105	3076 205

Trade Pack 10 Pieces



**Minnow Flyer**

A renowned lethal combination of a spinner attached to a rubber fish. All fish of the salmon family find this combination irresistible.

Length	Weight	green/red	silver/red	orange/silver	blue/silver
9,5 cm	3 g	3081 001	3081 101	3081 201	3081 301
12,0 cm	7 g	3081 002	3081 102	3081 202	3081 302
16,5 cm	13 g	3081 003	3081 103	3081 203	3081 303

Trade Pack 10 Pieces



**Mullet Spinner**

Specialist lure for mullet sport. 4g

Code	Weight
3071 001	4 g

Trade Pack 10 Pieces



**Mullet Spinner**

Specifically designed to fish with worm bait for mullet. The simple yet devastating design is a must have for beginners and serious mullet anglers. It is simple to use and other fish such as flounder can also be targeted.

Code	Length	Colour	Weight
3090 001	20 cm	silver	7 g

Trade Pack 10 Pieces



**Minnow Diver**

In tests this small fish imitator proved a magical lure for perch, chub and trout.

Length	Action	pearl/green	red/white	blue mackerel	trout	red/gold	minnow
6,5 cm	sinking	3427 001	3427 101	3427 201	3427 301	3427 401	3427 501

Trade Pack 5 Pieces



**Tall Flyer**

Swimming plug in a proven classic design. Wide range of uses from pike and zander to sea trout.

Length	Action	pearl/green	red/white	blue mackerel	trout	red/gold	minnow
10,5 cm	floating	3421 001	3421 101	3421 201	3421 301	3421 401	3421 501

Trade Pack 5 Pieces





**Slo Mo**

This small ball plug is designed to allow a particularly slow retrieve. Tempts perch, pike and trout.

Length	Action	pearl/green	red/white	blue mackerel	trout	red/gold	minnow
5,0 cm	floating	3423 001	3423 101	3423 201	3423 301	3423 401	3423 501

Trade Pack 5 Pieces



**Troublemaker**

Guaranteed to infuriate perch, pike and similar! This wobbler magically attracts anything that likes to take medium-sized silver fish and is available in three lengths.

Length	Action	roach	firetiger	red head	dark graze	argentic orange	stint
110 mm	floating	3444 001	3444 002	3444 003	3444 004	3444 005	3444 006
135 mm	floating	3444 101	3444 102	3444 103	3444 104	3444 105	3444 106
160 mm	floating	3444 201	3444 202	3444 203	3444 204	3444 205	3444 206

Trade Pack 5 Pieces



**Ross the Boss**

Three piece wobbler with diving blade with highly attractive retrieve action. As a suspender, the lure hangs in the water when the retrieve is stopped, which frequently tempts a bite. Excellent for pike, large perch, zander and members of the salmon family.

Length	Weight	Action	silver/gold/violet	firetiger	silver/brown/red	transparent/green/yellow	transp.red/brown/black	transp.blue/brown
13 cm	18 g	suspender	3401 001	3401 002	3401 003	3401 004	3401 005	3401 006

Trade Pack 5 Pieces







grass frog



pool frog



tree frog

With twin hook and weed protection.



**Top Frog**

Cool frog imitation that should be in every lure box when it comes to surface fishing for pike and black bass.

Length	Weight	grass frog	pool frog	tree frog
65 mm	19 g	3103 301	3103 302	3103 303

Trade Pack 5 Pieces



**Trophy Spoon Season Set 1**

Value-for-money sea trout and bass spoon set – suitable for all four seasons!

Code	Length	Colour	Content	Action
3082 997	6 cm	mix	4 pcs	sinking

Trade Pack 10 Pieces



**Trophy Spoon Season Set 2**

Value-for-money sea trout and bass spoon set – suitable for all four seasons!

Code	Length	Colour	Content	Action
3082 998	8 cm	mix	4 pcs	sinking

Trade Pack 10 Pieces



**Spinner Assortment Trout/Zander**

Code	3610 005
Trade Pack	5 Pieces



**Spinner Assortment. Pike/Perch**

Code	3610 006
Trade Pack	5 Pieces





**Spinner Assortment Long flex**

Code  
3610 010  
Trade Pack 5 Pieces



**Spinner Assortment Black Killer**

Code  
3610 011  
Trade Pack 5 Pieces



**Spinner Set Big**

Code  
3610 003  
Trade Pack 5 Pieces



**Spinner Set Sounder**

Code  
3610 004  
Trade Pack 5 Pieces



**Spinner Assortment Long Killer**

Code  
3610 012  
Trade Pack 5 Pieces



**Spinner Assortmentt Holo**

Code  
3610 001  
Trade Pack 5 Pieces



**Spinner Assortment Jig**

Code  
3610 002  
Trade Pack 5 Pieces



**Spinner Assortment**

30 spinners in an attractive sales display. Ideal presentation which will attract every passing customer's attention. The spinners can also be purchased individually.

Code  
3610 032





**Shiner Float**

Code	BS
5065 001	10 g
5065 002	15 g
5065 003	20 g
5065 004	30 g

Trade Pack 10 Pieces



**Lighter Float**

Code	BS
5066 001	5 g
5066 002	8 g
5066 003	10 g
5066 004	15 g
5066 005	20 g

Trade Pack 10 Pieces



**Float Big**

Code	BS
5071 001	10 g
5071 002	15 g
5071 003	20 g
5071 004	30 g
5071 005	40 g
5071 006	60 g

Trade Pack 10 Pieces



**Breaklight Float cigar shaped**

Code	BS
5132 001	2 g
5132 002	4 g
5132 003	6 g
5132 004	8 g

Trade Pack 10 Pieces



**Breaklight Float drop shape**

Code	BS
5133 001	3 g
5133 002	6 g
5133 003	10 g

Trade Pack 10 Pieces



**Breaklight Float with interch. Lead**

Code	BS
5134 001	5 / 2 g
5134 002	8 / 2 g
5134 003	10 / 4 g

Trade Pack 10 Pieces



**Float Small**

Code	BS
5072 001	3 g
5072 002	5 g
5072 003	8 g

Trade Pack 10 Pieces



**Breaklight Float with inside line**

Code	BS
5130 001	8 g
5130 002	10 g
5130 003	12 g

Trade Pack 10 Pieces



**Breaklight Float Special**

Code	BS
5131 001	3 g
5131 002	5 g
5131 003	7 g
5131 004	10 g

Trade Pack 10 Pieces



**Breaklight Float loaded**

Code	BS
5136 001	2 / 1 g
5136 002	3 / 2 g
5136 003	4 / 2 g
5136 004	6 / 2 g

Trade Pack 10 Pieces



**Stemmild Float**

Code	BS	Content
5035 001	4 / 6 g	2 pcs
5035 002	5 / 8 g	2 pcs

Trade Pack 10 Pieces







HF Stillwater Float Inline

Code	Length	BS
5092 001	164 mm	4 g
5092 002	172 mm	5 g
5092 003	180 mm	6 g
5092 004	188 mm	7 g
5092 005	196 mm	8 g
5092 006	204 mm	9 g
5092 007	212 mm	10 g
5092 008	222 mm	12 g

Trade Pack 10 Pieces



HF Breaklight Float

Code	Length	BS
5096 001	168 mm	10 g
5096 002	173 mm	12 g

Trade Pack 10 Pieces



HF Breaklight Float

Code	Length	BS
5097 001	119 mm	4 g
5097 002	121 mm	5 g
5097 003	123 mm	6 g
5097 004	126 mm	7 g
5097 005	129 mm	8 g
5097 006	132 mm	10 g

Trade Pack 10 Pieces



Breaklight Float fixed

Code	BS
5076 001	1 g
5076 002	2 g
5076 003	3 g

Trade Pack 10 Pieces



Breaklight Float sliding

Code	BS
5077 001	1 g
5077 002	2 g
5077 003	3 g

Trade Pack 10 Pieces



Breaklight Float sliding

Code	BS
5078 001	3 g
5078 002	5 g
5078 003	8 g

Trade Pack 10 Pieces



HF Predator Float

Code	Length	BS
5098 001	200 mm	8 g
5098 002	211 mm	10 g
5098 003	219 mm	12 g
5098 004	228 mm	15 g
5098 005	239 mm	20 g

Trade Pack 10 Pieces



HF River Float

Code	Length	BS
5099 001	213 mm	5 g
5099 002	222 mm	6 g
5099 003	229 mm	7 g
5099 004	238 mm	8 g
5099 005	248 mm	10 g

Trade Pack 10 Pieces



Breaklight Float sliding

Code	BS
5079 001	2 g
5079 002	4 g
5079 003	6 g
5079 004	9 g

Trade Pack 10 Pieces



Breaklight Float sliding

Code	BS
5081 001	4 g
5081 002	6 g
5081 003	8 g
5081 004	10 g

Trade Pack 10 Pieces



Breaklight Float sliding

Code	BS
5082 001	4 g
5082 002	6 g
5082 003	8 g
5082 004	10 g

Trade Pack 10 Pieces





**Breaklight  
Float sliding**

Code	BS
5083 001	4 g
5083 002	6 g
5083 003	8 g
5083 004	10 g
5083 005	15 g

Trade Pack 10 Pieces



**Breaklight  
Float sliding**

Code	BS
5086 001	4 g
5086 002	6 g
5086 003	8 g
5086 004	10 g

Trade Pack 10 Pieces



**Breaklight  
Float sliding**

Code	BS
5087 001	3 g
5087 002	4 g
5087 003	6 g
5087 004	8 g
5087 005	10 g

Trade Pack 10 Pieces



**Float ZS2**

Code	BS
5142 001	0,20 g
5142 002	0,50 g
5142 003	0,75 g
5142 004	1,00 g

Trade Pack 10 Pieces



**Float ZS3**

Code	BS
5143 001	0,20 g
5143 002	0,30 g
5143 003	0,50 g

Trade Pack 10 Pieces



**Float ZS4**

Code	BS
5144 001	0,50 g
5144 002	0,75 g
5144 003	1,00 g
5144 004	1,50 g

Trade Pack 10 Pieces



**Breaklight  
Float inline**

Code	BS
5089 001	4 g
5089 002	6 g
5089 003	8 g
5089 004	10 g

Trade Pack 10 Pieces



**Breaklight  
Float inline**

Code	BS
5090 001	4 g
5090 002	6 g
5090 003	8 g
5090 004	10 g

Trade Pack 10 Pieces



**Stillwater  
Float**

Code	BS
5025 001	1 g
5025 002	2 g
5025 003	3 g
5025 004	4 g

Trade Pack 10 Pieces



**Float ZS6**

Code	BS
5146 001	0,40 g
5146 002	0,60 g
5146 003	0,80 g
5146 004	1,00 g

Trade Pack 10 Pieces



**Float ZS7**

Code	BS
5147 001	1,00 g
5147 002	2,50 g
5147 003	4,00 g

Trade Pack 10 Pieces



**Float ZS10**

Code	BS
5150 001	2,0 g
5150 002	3,00 g
5150 003	4,00 g
5150 004	5,00 g
5150 005	6,00 g
5150 006	7,00 g
5150 007	10,0 g

Trade Pack 10 Pieces





**Passy Float**

Code BS  
5040 001 3 g  
5040 002 5 g  
Trade Pack 10 Pieces



**Leman Float**

Code BS  
5041 001 4 g  
5041 002 6 g  
5041 003 8 g  
5041 004 12 g  
Trade Pack 10 Pieces



**Anterne Float**

Code BS  
5042 001 10 g  
5042 002 15 g  
Trade Pack 10 Pieces



**Posenset Delphine**

Code BS  
5056 001 0,30 / 0,40 / 0,70 g  
Trade Pack 10 Pieces



**Posenset Justine**

Code BS  
5056 002 0,30 / 0,40 / 0,60 g  
Trade Pack 10 Pieces



**Posenset Carine**

Code BS  
5056 003 0,20 / 0,30 / 0,50 g  
Trade Pack 10 Pieces



**Annecy Float**

Code BS  
5043 001 10 g  
5043 002 15 g  
5043 003 20 g  
5043 004 30 g  
Trade Pack 10 Pieces



**Azergue Float**

Code BS  
5044 001 3 g  
5044 002 5 g  
5044 003 8 g  
Trade Pack 10 Pieces



**Cheran Float**

Code BS  
5045 001 2 g  
5045 002 3 g  
5045 003 5 g  
Trade Pack 10 Pieces



**Posenset Capitole**

Code BS Content  
5046 001 0,30 / 0,50 / 0,70 g 3 pcs  
Trade Pack 10 Pieces



**Posenset Christine**

Code BS  
5056 004 0,30 / 0,50 / 0,80 g  
Trade Pack 10 Pieces



**Posenset Mix 1**

Code BS  
5056 005 0,40 / 0,30 g  
Trade Pack 10 Pieces





**Posenset Mix 2**

Code BS  
5056 006 0,50 g  
Trade Pack 10 Pieces



**Waggler, loaded**

Code BS  
5000 002 4 / 2 g  
5000 003 6 / 2 g  
5000 004 8 / 2 g  
Trade Pack 10 Pieces



**Waggler, loaded**

Code BS  
5005 001 4 g  
5005 002 5 g  
Trade Pack 10 Pieces



**Waggler, loaded**

Code BS  
5013 001 2 g  
5013 002 3 / 2 g  
5013 003 5 / 2 g  
Trade Pack 10 Pieces



**Waggler, loaded**

Code BS  
5014 001 3 / 2 g  
5014 002 5 / 2 g  
Trade Pack 10 Pieces



**Waggler, loaded**

Code BS  
5015 001 4 / 2 g  
5015 002 6 / 2 g  
5015 003 8 / 2 g  
5015 004 10 / 2 g  
Trade Pack 10 Pieces



**Predator Float**

Code	Length	BS
5260 001	45 mm	11 g
5260 002	55 mm	15 g
5260 003	68 mm	22 g
5260 004	80 mm	30 g
5260 005	90 mm	45 g
5260 006	100 mm	68 g
5260 007	120 mm	94 g

Trade Pack 10 Pieces



**Chrystal Voyager II Float**

Code	Length	BS
5525 001	96 mm	6 g
5525 002	115 mm	10 g
5525 003	145 mm	15 g

Trade Pack 10 Pieces



**Delphine Ready-made rigs**

Code	Length	Hook Size	Mainline Ø	Leader L. Ø	BS
5514 002	7,00 m	18	0,12 mm	0,10 mm	0,4 g
5514 003	7,00 m	16	0,14 mm	0,10 mm	0,7 g

Trade Pack 10 Pieces



**Christine Ready-made rigs**

Code	Length	Hook Size	Mainline Ø	Leader L. Ø	BS
5511 001	7,00 m	20	0,12 mm	0,20 mm	0,3 g
5511 002	7,00 m	18	0,12 mm	0,10 mm	0,5 g

Trade Pack 10 Pieces



**Amandine Ready-made rigs**

Code	Length	Hook Size	Mainline Ø	Leader L. Ø	BS
5512 001	7,00 m	20	0,12 mm	0,12 mm	0,2 g
5512 002	7,00 m	18	0,12 mm	0,10 mm	0,3 g
5512 003	7,00 m	16	0,14 mm	0,10 mm	0,5 g
5512 004	7,00 m	14	0,16 mm	0,12 mm	0,7 g

Trade Pack 10 Pieces

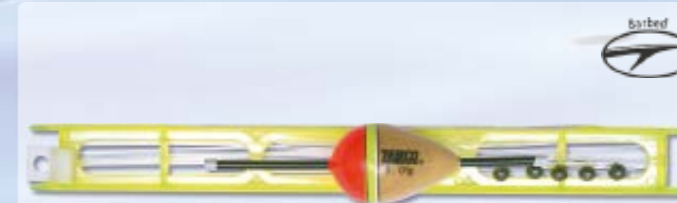

**Azergue Ready-made rigs**

Code	Length	Hook Size	Mainline Ø	Leader L. Ø	BS
5500 001	7,00 m	10	0,22 mm	0,20 mm	3 g
5500 002	7,00 m	8	0,22 mm	0,20 mm	5 g

Trade Pack 10 Pieces



**Cherran Ready-made rigs**

Code	Length	Hook Size	Mainline Ø	Leader L. Ø	BS
5501 001	7,00 m	10	0,22 mm	0,20 mm	3 g

Trade Pack 10 Pieces



**Emma Ready-made rigs**

Code	Length	Hook Size	Mainline Ø	Leader L. Ø	BS
5502 001	7,00 m	12	0,20 mm	0,20 mm	3 g
5502 002	7,00 m	10	0,20 mm	0,18 mm	5 g
5502 003	7,00 m	8	0,22 mm	0,18 mm	7 g

Trade Pack 10 Pieces





**Allround Ready-made rigs**

Code	Length	Hook Size	Mainline Ø	Leader L. Ø	BS
5585 001	7,00 m	16	0,12 mm	0,30 mm	0,75 g
5585 002	7,00 m	16	0,14 mm	0,10 mm	1 g
5585 003	7,00 m	14	0,14 mm	0,12 mm	2 g
5585 004	7,00 m	12	0,16 mm	0,12 mm	4 g

Trade Pack 10 Pieces



**Stillwater Ready-made rigs**

Code	Length	Hook Size	Mainline Ø	Leader L. Ø	BS
5586 001	7,00 m	16	0,12 mm	0,14 mm	0,8 g
5586 002	7,00 m	16	0,14 mm	0,10 mm	1 g
5586 003	7,00 m	14	0,16 mm	0,12 mm	1,5 g
5586 004	7,00 m	14	0,16 mm	0,14 mm	2 g

Trade Pack 10 Pieces



**River Ready-made rigs**

Code	Length	Hook Size	Mainline Ø	Leader L. Ø	BS
5587 001	7,00 m	16	0,12 mm	0,14 mm	0,75 g
5587 002	7,00 m	16	0,14 mm	0,10 mm	1 g
5587 003	7,00 m	14	0,16 mm	0,12 mm	1,5 g
5587 004	7,00 m	14	0,16 mm	0,14 mm	2 g
5587 005	7,00 m	14	0,16 mm	0,14 mm	3 g
5587 006	7,00 m	14	0,16 mm	0,14 mm	4 g

Trade Pack 10 Pieces



**Allround Ready-made rigs**

Code	Length	Hook Size	Mainline Ø	Leader L. Ø	BS
5588 001	7,00 m	16	0,12 mm	0,14 mm	0,75 g
5588 002	7,00 m	16	0,14 mm	0,10 mm	1 g
5588 003	7,00 m	14	0,16 mm	0,12 mm	1,5 g
5588 004	7,00 m	14	0,16 mm	0,14 mm	2 g
5588 005	7,00 m	14	0,16 mm	0,14 mm	2,5 g

Trade Pack 10 Pieces



**Allround Ready-made rigs**

Code	Length	Hook Size	Mainline Ø	Leader L. Ø	BS
5589 001	7,00 m	18	0,12 mm	0,14 mm	0,5 g
5589 002	7,00 m	16	0,12 mm	0,10 mm	0,75 g
5589 003	7,00 m	14	0,16 mm	0,10 mm	1 g
5589 004	7,00 m	14	0,16 mm	0,14 mm	1,5 g
5589 005	7,00 m	14	0,16 mm	0,14 mm	2 g
5589 006	7,00 m	14	0,16 mm	0,14 mm	3 g

Trade Pack 10 Pieces



**River Ready-made rigs**

Code	Length	Hook Size	Mainline Ø	Leader L. Ø	BS
5590 002	7,00 m	14	0,16 mm	0,12 mm	1,5 g
5590 003	7,00 m	14	0,16 mm	0,14 mm	2 g
5590 004	7,00 m	14	0,16 mm	0,14 mm	3 g
5590 005	7,00 m	14	0,16 mm	0,14 mm	4 g

Trade Pack 10 Pieces



**Tool Box Eco**

With a compact design, yet spacious interior, you will always have storage space for your hooks and lures etc. The convenient transparent lid means you can see the contents without opening.

Code	Width	Height	Depth	Size	Colour
8032 001	15 cm	17 cm	30 cm	S	green
8032 002	23 cm	26 cm	46 cm	L	green

Trade Pack 6 Pieces



**Tackle Boxes**

To keep all your accessories neat and readily available. Hooks, rigs, floats and artificial bait – there is a place for everything in this box. The robust housing is very strong, yet flexible.

Code	Width	Height	Depth
8020 000	30 cm	15 cm	15 cm
8021 000	37 cm	18 cm	16 cm



**Tackle Boxes**

To keep all your accessories neat and readily available. Hooks, rigs, floats and artificial bait – there is a place for everything in this box. The robust housing is very strong, yet flexible.

Code	Width	Height	Depth
8022 000	42 cm	22 cm	20 cm



**Allround Seat Box**

Compact Design so it always fits in the car, but still has the capacity to hold all the essentials. Extremely robust finish with latches and carry strap, a top storage section and large storage compartment at the bottom.

Code	Width	Height	Depth
8023 001	34 cm	17 cm	37 cm

Trade Pack 2 Pieces





**Mega Storer Tackle Box**

A practical partner for fishing trips. The box provides sufficient space for storing baits and tackle and also makes an ideal seat. Made from shock-resistant plastic.

Code	Length	Width	Height
8023 010	42 cm	33 cm	38 cm

Trade Pack 5 Pieces



**Organizer**

As the name suggests, this is the ideal solution for keeping those small accessories nice and tidy, and of course safe and dry.

Code	Width	Height	Depth	Size	Colour
8034 001	3,5 cm	15 cm	19 cm	S	red/black

Trade Pack 5 Pieces



**Bait Container**

Model	Ø	green
Bait Box	70 mm	8170 070
Bait Box	90 mm	8170 090
Bait Box	100 mm	8170 100
Worm Box S	85 mm	8174 001
Worm Box L	105 mm	8174 002

Trade Pack 10 Pieces



**Lure Box XXL**

Changing lures just got easier! The Lure Box XXL offers enough space to take a comprehensive, well-arranged assortment of lures on every trip. Even large wobblers and jerkbaits are comfortably swallowed up by this tackle box. The innovative design has two connected but separate boxes which can be split allowing you to take only one half of the box where this will suffice.

Code	Width	Height	Depth	Size	Colour
8035 001	13 cm	29 cm	39 cm	XXL	red/black

Trade Pack 4 Pieces



**Universal Accessories Box**

A smoke coloured transport box for lures and other accessories. With vertical partitions, and numerous options for horizontal divisions. The housing is shock proof, resistant to soft plastic lures and fitted with strong latches.

Code	Width	Height	Depth
8061 020	32 cm	21 cm	6 cm

Trade Pack 5 Pieces



**Wobblerbox**

Transparent transport box for wobblers and pirkers. Loads on either side to save extra space. Internal partitions prevent hooks from becoming hopelessly tangled with lures. The housing is shock proof, resistant to soft plastic lures and fitted with strong latches.

Code	Width	Height	Depth
8061 018	27 cm	17 cm	4,5 cm

Trade Pack 5 Pieces



**Magnetic Hook Box**

Code	Width	Height	Depth
8061 005	14,5 cm	11,5 cm	2 cm

Trade Pack 5 Pieces



**Twisterbox**

Code	Width	Height	Depth
8061 002	18 cm	10 cm	3 cm

Trade Pack 10 Pieces



**Accessories Box**

Code	Width	Height	Depth
8061 003	18 cm	8 cm	3 cm

Trade Pack 10 Pieces





**Double-Sided Bait Box**

Code	Width	Height	Depth
8061 006	19 cm	11 cm	5 cm

Trade Pack 10 Pieces



**Vario Plastic Bait Box S**

With flexible internal compartments.

Code	Width	Height	Depth
8061 025	20 cm	13,5 cm	4 cm

Trade Pack 5 Pieces



**Vario Plastic Bait Box M**

With flexible internal compartments.

Code	Width	Height	Depth
8061 026	25 cm	17,5 cm	4 cm

Trade Pack 5 Pieces



**Vario Plastic Bait Box L**

With flexible internal compartments.

Code	Width	Height	Depth
8061 009	36 cm	23 cm	5 cm

Trade Pack 5 Pieces



**Baitfish & Bait bucket, round**

Versatile bucket for holding baitfish. Can also be used with extra sieve insert or as a bait bowl.

Code	Model	Contents
8126 005	Baitfish & Bait bucket, round	12 l
8126 006	Baitfish & Bait bucket, round	18 l

Trade Pack 5 Pieces



Grid insert. Filleting board with rubber feet



**Angling Bucket**

With filleting board and drip mesh. Clever inventions for clever anglers: You can either put your catch straight into the bucket or simply fillet it immediately on the lid board. The mesh in the bucket allows the fish or fillet to drip without it lying in its own juice. At 51x25x27 cm the bucket has a big capacity to cope with most fish. With filleting board and drip mesh. Comes without bucket, boxes and accessories.

Code	Width	Height	Depth
8514 006	51 cm	25 cm	27 cm



**Bait Fish Kettle**

With mesh insert

Code	Contents
8126 000	7 l



**Rig Winder Box**

Practical box for storing sea rigs and leaders. Includes 3 x 5 EVA winders.

Code	Width
8061 021	44 cm

Trade Pack 5 Pieces





**Rig Winder, round**

Code	Ø	Height	Content	Colour
6783 001	50 mm	15 mm	9 pcs	yellow
6783 002	60 mm	15 mm	9 pcs	green
6783 003	80 mm	25 mm	6 pcs	blue

Trade Pack 10 Pieces



**Rig Winder, rectangular**

Code	Width	Height	Depth	Content	Colour
6783 005	55 mm	150 mm	14 mm	6 pcs	black/yellow
6783 006	60 mm	150 mm	8 mm	9 pcs	black/yellow

Trade Pack 10 Pieces



**Round Leader Box**

Box with 12 round neoprene winders for transporting leaders tidily. Shock-proof plastic.

Code	Ø	Width
8061 015	5,5 cm	20 cm

Trade Pack 5 Pieces



**Flat Leader Box**

Box with 8 round neoprene winders for transporting leaders tidily. Shock proof plastic.

Code	Width	Height
8061 016	20 cm	11,5 cm

Trade Pack 5 Pieces



**Pulsator 2-Speed**

Powerful oxygen pump for transporting live bait, 2 speed levels. Batteries: 1xC (not included).

Code
9912 001



**Multi-Pulsator 2-Speed**

Modified version of our popular two speed bait fish pump. In contrast to the battery only version, the multi pulsator can also be operated via the mains (220 V) or via a car cigarette lighter (12 V). Batteries: 2xC (not included).

Code
9912 002



**Float Box**

Adjustable length

Code	Length	Ø
8081 001	33 - 49 cm	3,5 cm
8081 002	35 - 53 cm	5 cm
8081 003	40 - 59 cm	7 cm

Trade Pack 5 Pieces





**Pro Staff Chair DX**

The Mercedes of folding chairs. Extremely high-quality finish with an extra high backrest that also acts as a headrest. Includes two drinks holders, one in each armrest. The frame is powder coated and, hence, extremely durable. Material: 100% Polyester

Code	Length	Width	Height
9984 001	48 cm	52 cm	82 cm



**Pro Staff Chair Supreme**

Ultra-robust folding chair with powerful legs and footplates to prevent sinking in soft ground. Extremely high-quality finish. Includes a drinks holder. The frame is powder coated and, hence, extremely durable. Material: 100% Polyester

Code	Length	Width	Height
9984 002	42 cm	54 cm	65 cm



**Pro Staff Chair FG**

Flat chair with a well ventilated, net fabric seat. Also perfect for trips to the beach, etc. An amazingly relaxing chair to sit on. The frame is powder coated and, hence, extremely durable. Material: 100% Polyester

Code	Length	Width	Height
9984 005	41 cm	58 cm	59 cm



**Pro Staff Chair Mini**

A small chair with strengths you may not notice at first glance. Despite the compact size, the chair is very comfortable to sit in and saves space and weight during transport. Ideal for stalking. The frame is powder coated and, hence, extremely durable. Material: 100% Polyester

Code	Length	Width	Height
9984 006	34 cm	32 cm	37 cm



**Pro Staff Chair SX**

Ultra-robust folding chair with particularly robust oval frame. Extremely high-quality finish with comfortable armrests. The frame is powder coated and, hence, extremely durable. Material: 100% Polyester

Code	Length	Width	Height
9984 003	41 cm	54 cm	62 cm



**Pro Staff Chair BS**

A proven and incredibly popular chair design that sets up in no time. With a drinks holder in the armrest. The frame is powder coated and, hence, extremely durable. Material: 100% Polyester

Code	Length	Width	Height
9984 004	42 cm	58 cm	55 cm



**Pro Staff Day Walker**

The world champion of chairs, when it comes to the smallest storage space and speed of assembling. Material: 100% Polyester

Code	Length	Width
9984 007	38 cm	38 cm



**Pro Staff RH Chair**

Comfortable chair with an integral rod rest for up to three rods. Material: 100% Polyester

Code	Length	Width	Height
9984 008	26 cm	32 cm	73 cm





**Pro Staff BP Chair**

The lightest of our chairs, yet with a lot of storage space. Material: 100% Polyester

Code	Length	Width	Height
9984 009	34 cm	33 cm	41 cm



**Tackle Cart**

Lightweight trolley for seat boxes, boxes and bags. Takes the unpleasantness out of even long walks to the water.

Code	Length	Width	Height	Weight
8702 002	40 cm	31 cm	1 m	4,5 kg



**Beach Tent**

The Zebco Surf Tent offers perfect protection from the wind and rain. The tent can comfortably accommodate two people. The low packing dimensions and extremely light weight, as well as lightning-fast set-up, make this stable home from home a perfect partner on the shore. Supplied in a practical transport bag including pegs for secure pitching. Material: 210D PU

Code	Length	Width	Height	Colour
9969 001	130 cm	140 cm	160 cm	blue/black



**Zebco Pro Staff Beach Trolley**

The Zebco Pro Staff Beach Trolley is both an ingenious transport aid and a comfortable seat for the angler. The frame is made from rust-proof, light aluminium and folds together economically with no tools. Material: 100% Polyester

Code	Length	Width	Height	Weight
8700 001	45 cm	69 cm	104 cm	4,70 kg



**Trolley Beach Wheel Kits**

Extra-wide axle for mounting extra-thick beach wheels.

Code	Width
8790 001	27 cm

Trade Pack 2 Pieces



**Trolley Beach Wheel**

Ultra-wide balloon wheels for use on the beach and rough terrain. The diameter for axle mounting is 2.3 cm, which does not fit absolutely every trolley, so compensating bushes should be used where necessary. Compensating bushes are not included.

Code	Ø	Width
9799 001	27 cm	17 cm



**Nylon Umbrella**

Moderately priced 45" angling umbrella made from 210 D Nylon. Size of umbrella when open: 2.20m. Tilt: 45° and 90°.

Code	Ø
9973 220	2,20 m





**Nylon Camou Umbrella**

Popular fishing umbrella in modern, discreet Camou design. Material: 100% Nylon, Polychlorid coated

Code Ø  
9973 221 2,20 m



**Nylon Camou Storm Umbrella**

Popular storm umbrella in modern, discreet Camou design. Material: 100% Nylon, Polychlorid coated

Code Ø  
9974 253 2,20 m



Zip goes round all sides

**Storm Umbrella**

Standard type umbrella with detachable storm sides. Windows to each side, height adjustable pole. Supplied with guy ropes and pegs in a cloth bag Material: 100% Nylon, Polychlorid coated

Code Ø  
9974 250 2,50 m  
9974 252 2,20 m



**Speed Brolly**

Brolly that erects in the blink of an eye. With sealed seams and two storm poles included. Material: 100% Nylon

Code Width Height Depth Weight  
9976 002 200 cm 136 cm 148 cm 2,70 kg





**Brolly II**

Practical, free-standing broolly with 2.50 m diameter in popular "angling green". Material: 100% Nylon, Polychlorid coated

Code	Ø	Weight
9979 250	2,50 m	2,2 kg



**Pro Staff All In Carry All**

The Zebco Pro Staff bag series impresses with its ultra-modern designs and first-class finishing at moderate prices. The All in Carryall is a transport bag for five small accessories boxes, which are included. With zip fastener and carry handle. Material: 100% Polyester

Code	Length	Width	Height
8407 001	29 cm	22 cm	21 cm



**Pro Staff Uni Tackle Keeper Bag**

The Zebco Pro Staff bag series impresses with its ultra-modern designs and first-class finishing at moderate prices. The Uni Tackle Keeper is a transport bag for one large and two small accessory boxes, which are included. Material: 100% Polyester

Code	Length	Width	Height
8407 002	37 cm	18 cm	24 cm



**Ground spike for fishing umbrella**

Code	Length
9974 999	34 cm

Trade Pack 5 Pieces



**Pro Staff Lure Keeper Bag S**

The Zebco Pro Staff bag series impresses with its ultra-modern designs and first-class finishing at moderate prices. The Lure Keeper Bag S is a transport bag for three artificial lure boxes, which are included. With snap fasteners and carry handle. Material: 100% Polyester

Code	Length	Width	Height
8407 003	22 cm	13 cm	14 cm



**Pro Staff Rig and Tool Bag**

The Zebco Pro Staff bag series impresses with its ultra-modern designs and first-class finishing at moderate prices. The Rig & Tool Bag is an accessory bag with two main compartments. With zip fasteners and carry handle. Additional option for chaining the bag to railings, etc. Material: 100% Polyester

Code	Length	Width	Height
8407 004	21 cm	14 cm	7 cm





**Pro Staff Rig and Lure Bag**

The Zebco Pro Staff bag series impresses with its ultra-modern designs and first-class finishing at moderate prices. The Rig & Lure Bag is an accessory bag with one main compartment plus inserts for transporting artificial lures and one compartment with an accessory box (included). With zip fasteners and carry handle. Material: 100% Polyester

Code	Length	Width	Height
8407 005	30 cm	16 cm	20 cm



**Pro Staff Rig Bag Pro**

The Zebco Pro Staff bag series impresses with its ultra-modern designs and first-class finishing at moderate prices. The Rig Bag Pro is an accessory bag for transporting angling rigs in separate folders. With push-button fastener. Material: 100% Polyester

Code	Length	Width
8407 006	24 cm	17 cm



**Pro Staff Lure and Rig Wallet**

The Zebco Pro Staff bag series impresses with its ultra-modern designs and first-class finishing at moderate prices. The Lure & Rig Wallet is an accessory bag for economical transport of lures and accessories. With zip fastener. Material: 100% Polyester

Code	Length	Width
8407 009	29 cm	20 cm



**Pro Staff Colossus Bag**

The Zebco Pro Staff bag series impresses with its ultra-modern designs and first-class finishing at moderate prices. The Colossus Carryall is a gigantic, spacious transport bag with three accessory pockets, zip fasteners and carry handle. Material: 100% Polyester

Code	Length	Width	Height
8407 013	67 cm	31 cm	35 cm



**Pro Staff Uni Tackle Bag**

The Zebco Pro Staff bag series impresses with its ultra-modern designs and first-class finishing at moderate prices. The Uni Tackle Bag is a versatile accessory bag for transporting angling rigs in separate folders and small parts in a small accessory box (included). With zip fastener and carry handle. Material: 100% Polyester

Code	Length	Width	Height
8407 007	22 cm	11 cm	16 cm



**Pro Staff Deluxe Carry All**

The Zebco Pro Staff bag series impresses with its ultra-modern designs and first-class finishing at moderate prices. The Deluxe Carryall is a transport bag for four small accessories boxes, which are included. With three accessory pockets, a carry strap, zip fasteners and carry handle. Material: 100% Polyester

Code	Length	Width	Height
8407 008	41 cm	25 cm	20 cm



**Pro Staff Tele Rod Bag**

The Zebco Pro Staff bag series impresses with its ultra-modern designs and first-class finishing at moderate prices. Tele Rod Bags are proven telescopic rod holdalls with two main compartments and a number of accessory pockets for transporting accessories (e.g. landing nets) and small parts. With zip fasteners, snap fasteners and shoulder straps. Material: 100% Polyester

Code	Length	Width	Height
8407 010	1,20 m	25 cm	32 cm
8407 011	1,30 m	25 cm	32 cm
8407 012	1,50 m	31 cm	32 cm



**Pro Staff Single Rod Bag**

The Zebco Pro Staff bag series impresses with its ultra-modern designs and first-class finishing at moderate prices. The Single Rod Bags are proven rod holdalls with one main compartment and a recess for transporting a rod with the reel attached. With zip fastener and shoulder straps. Material: 100% Polyester

Code	Length
8407 014	1,50 m
8407 015	1,70 m
8407 016	1,90 m





**Pro Staff Tele Float Rod Bag**

The Zebco Pro Staff bag series impresses with its ultra-modern designs and first-class finishing at moderate prices. The Tele Float Rod Bags are proven rod holdalls with two and three main compartments and recesses for transporting rods with reels attached. With zip fastener and shoulder straps. Material: 100% Polyester

Code	Length	Width	Height
8407 017	1,65 m	35 cm	18 cm
8407 018	1,65 m	40 cm	18 cm



**Jumbo Bag**

Useful spacious carryall made of coated nylon with an extra strong strap. Suitable for carrying overalls, waders, rubber boots and many other accessories. Material: 100% Nylon

Code	Width	Height	Depth
8420 001	49 cm	32 cm	41 cm



**Allround Carryall**

Multi purpose bag with two additional outer pockets. A useful carryall for holiday fishing – in various sizes for your individual needs. Material: 100% Nylon

Code	Width	Height	Depth
8420 002	39 cm	24 cm	24 cm
8420 003	49 cm	28 cm	28 cm



**Pro Staff Allround Carryall**

The Zebco Pro Staff bag series impresses with its ultra-modern designs and first-class finishing at moderate prices. The Allround Carryall is a spacious transport bag with two accessory pockets, zip fasteners and carry handle. Supplied with two accessory boxes. Material: 100% Polyester

Code	Length	Width	Height
8407 019	39 cm	15 cm	28 cm



**Lure Bag**

A shoulder bag for transporting artificial lures containing three lure boxes. The Zebco Lure Bag has room for every lure, meaning nothing will go missing. Material: 100% Nylon

Code	Width	Height	Depth
8420 024	36 cm	26 cm	26 cm



**Shoulder Bag**

Material: 100% Nylon

Code	Width	Height	Depth
8420 022	38 cm	12 cm	30 cm





**Fish Basket**

Material: 100% Nylon

Code	Width	Height	Depth
8420 023	39 cm	20 cm	19 cm

**Tele-Holdall**

Lots of separate compartments for the safe transport of sensitive telescopic rods (e.g. light Bolognese rods) to the water's edge. Lots of room, yet comfortable to carry. Material: 100% Nylon

Code	Length	Height	Depth
8420 011	135 cm	26 cm	27,5 cm
8420 012	150 cm	26 cm	27,5 cm



Carrying strap for back pack



**Telescopic Rod Holdall**

Highly reinforced telescopic rod holdall. Integrated reinforced seam ensures that it retains its shape. Material: 100% Nylon

Code	Length	Height	Depth
8420 015	125 cm	22 cm	18 cm
8420 016	150 cm	22 cm	18 cm



**Standard Holdall**

Rod bag for up to four completely made-up rods. An additional outer pocket offers space for umbrella and landing net. The straps have been especially reinforced. Material: 100% Nylon

Code	Length	Height	Depth
8420 007	100 cm	15 cm	24 cm
8420 008	125 cm	15 cm	24 cm
8420 009	150 cm	15 cm	24 cm
8420 010	165 cm	15 cm	24 cm



**Rod Holdall**

For transport of single rods. Material: 100% Nylon

Code	Length	Height	Depth
8420 004	125 cm	10 cm	8 cm
8420 005	150 cm	10 cm	8 cm
8420 006	170 cm	10 cm	8 cm

**Surf Rod Holdall**

Excellent quality at an unbeatable price. With special reel storage space, providing enough room for even large surf reels. Material: 100% Nylon

Code	Length	Height	Depth
8420 013	175 cm	23 cm	27 cm



Carrying strap for back pack





**Universal Tackle Carrier**

Extremely spacious bag capable of accommodating rods, banksticks, small accessories and much more. Material: 100% Nylon

Code	Length	Width	Height
8420 030	135 cm	40 cm	20 cm
8420 031	165 cm	40 cm	20 cm



**Rig Wallet Set**

Professional set for surf, lure and carp fishing. Material: 100% Nylon

Code	Width	Height
8420 019	34 cm	23 cm

Trade Pack 3 Pieces



**Medium Rig Wallet**

Material: 100% Nylon

Code	Width	Height
8420 018	12 cm	16 cm

Trade Pack 5 Pieces



**Telescopic Rod Holdall Mega Set**

Ideal for the Retail Trade: unbeatable on price, a set containing three of each of the ten most popular telescopic rod holdalls. Do not miss this opportunity. 10x Telescopic Rod Holdall 1.00 m 10x Telescopic Rod Holdall 1.25 m 10x Telescopic Rod Holdall 1.35 m Material: 100% Nylon

Code
8420 999



**Unhooking Mat**

Simple yet versatile unhooking mat at an extremely attractive price. Material: 100% Nylon

Code	Length	Width
8420 043	0,75 m	0,45 m

Trade Pack 5 Pieces



**Rail Rod Holder**

Protects rods and holds them firmly at the desired angle. Material: 100% Nylon

Code	Width	Height
8420 020	19 cm	6 cm

Trade Pack 10 Pieces



**Single Ready Bag**

Practical holdall for transporting rigged-up rods. Be ready to fish in minutes with the Single Ready Rod Bag! Material: 100% Nylon

Code	Length	Width	Height
8420 027	125 cm	14 cm	25 cm
8420 028	150 cm	14 cm	25 cm
8420 029	170 cm	14 cm	25 cm



**Rod Velcro Strip**

Ideal for transporting fishing rods. Material: 100% Nylon

Code	Width	Height
8420 021	18 cm	4 cm

Trade Pack 10 Pieces





### Trophy Tele Landing Net

Robust telescopic landing net with quick-locking mechanism Practical and reliable to avoid fish slipping away at the last minute.

Code	Length	Width	Height	Depth	Sections	Tr.-Length	Mesh
7054 160	1,60 m	50 cm	50 cm	50 cm	2	0,60 m	8 x 8 mm
7054 190	1,90 m	50 cm	50 cm	50 cm	2	0,75 m	8 x 8 mm
7054 240	2,40 m	60 cm	60 cm	50 cm	3	0,81 m	8 x 8 mm
7054 270	2,70 m	60 cm	60 cm	50 cm	3	0,91 m	8 x 8 mm
7054 300	3,00 m	60 cm	84 cm	50 cm	3	1,01 m	8 x 8 mm



### De Luxe Telescopic Landing Net

• Very strong aluminium net handle with an octagonal profile • Rubber grip and belt clip • Strong aluminium frame (6mm Ø) • Folding mechanism made of metal • Mesh size 6mm • Fast drying net • The two or three piece handle can be locked at any length.

Code	Length	Width	Height	Depth	Sections	Tr.-Length	Mesh
7026 150	1,50 m	60 cm	50 cm	60 cm	2	0,60 m	6 x 6 mm
7026 180	1,80 m	60 cm	50 cm	60 cm	3	0,70 m	6 x 6 mm
7026 200	2,00 m	60 cm	50 cm	60 cm	3	0,76 m	6 x 6 mm
7026 250	2,50 m	60 cm	50 cm	60 cm	3	0,78 m	6 x 6 mm
7026 300	3,00 m	60 cm	50 cm	60 cm	3	0,82 m	6 x 6 mm



Light weight all-round landing net

### Tele Landing Net

• Mesh width 6 mm • Length adjustable • Reliable folding mechanism • Light weight and easy to use • Quick drying net

Code	Length	Width	Height	Sections	Tr.-Length	Mesh
7028 160	1,60 m	40 cm	40 cm	2	0,60 m	6 x 6 mm
7028 180	1,80 m	40 cm	40 cm	2	0,70 m	6 x 6 mm
7028 200	2,00 m	50 cm	50 cm	2	0,80 m	6 x 6 mm
7028 240	2,40 m	50 cm	50 cm	2	1,00 m	6 x 6 mm



### Tele Rubber Net

Landing fish safely is an essential part of angling but it can be frustrating when the hook catches in the landing net mesh. With the rubberised Tele Rubber Net hooks can be freed in seconds allowing the angler to care for the fish properly.

Code	Length	Width	Height	Depth	Sections	Tr.-Length	Mesh
7034 160	1,60 m	50 cm	50 cm	50 cm	2	0,70 m	10 x 10 mm
7034 190	1,90 m	50 cm	50 cm	50 cm	2	0,85 m	10 x 10 mm
7034 210	2,10 m	60 cm	60 cm	50 cm	3	0,71 m	10 x 10 mm
7034 240	2,40 m	60 cm	60 cm	50 cm	3	0,81 m	10 x 10 mm
7034 270	2,70 m	60 cm	60 cm	50 cm	3	0,91 m	10 x 10 mm
7034 300	3,00 m	60 cm	60 cm	50 cm	3	1,01 m	10 x 10 mm



### Wide Mesh Telescopic Landing Net

Especially suitable for river fishing due to its large mesh size. • Very strong aluminium net handle with an octagonal profile. • Rubber grip and belt clip • Strong aluminium frame (6mm Ø) • Reliable folding mechanism • Mesh size 8mm • Fast drying net • The two piece handle can be locked at any length.

Code	Length	Width	Height	Depth	Sections	Tr.-Length	Mesh
7027 140	1,40 m	60 cm	50 cm	50 cm	2	0,58 m	8 x 8 mm
7027 175	1,75 m	60 cm	50 cm	50 cm	2	0,70 m	8 x 8 mm
7027 200	2,00 m	60 cm	50 cm	60 cm	2	0,80 m	8 x 8 mm
7027 250	2,50 m	60 cm	50 cm	60 cm	2	1,05 m	8 x 8 mm
7027 251	2,50 m	70 cm	60 cm	60 cm	2	1,10 m	8 x 8 mm
7027 300	3,00 m	70 cm	60 cm	60 cm	3	1,05 m	8 x 8 mm



### Trout Gripper

Affordable, handy wading landing net for trout fishing in small streams for example. Fish-friendly mesh fabric.

Code	Length	Width	Height	Depth	Mesh
7037 055	55 cm	30 cm	37 cm	30 cm	5 x 5 mm
7037 080	80 cm	30 cm	38 cm	21 cm	4 x 4 mm



### Pond Net

Small net for removing leaves or other refuse from garden ponds. Robust, telescopic aluminium handle. Fine mesh net.

Code	Length	Width	Height	Tr.-Length	Mesh
7038 200	2,00 m	25 cm	17,5 cm	1,15 m	3 x 3 mm

Trade Pack 5 Pieces





**Keepnets**

Eco Mono Keepnet.

Code	Length	Ø	Mesh
7032 150	1,50 m	40 cm	6 x 6 mm
7032 200	2,00 m	40 cm	6 x 6 mm
7032 250	2,50 m	40 cm	6 x 6 mm
7032 350	3,50 m	50 cm	6 x 6 mm



**Keepnets**

Thanks to the stable design with a mesh size of 6mm this keepnet can be used in either fresh-water or saltwater.

Code	Length	Ø	Mesh
7004 060	0,60 m	35 cm	6 x 6 mm
7004 090	0,90 m	35 cm	6 x 6 mm
7004 120	1,20 m	35 cm	6 x 6 mm



**Umbrella Style Livebait Net**

With extra high walls. Particularly useful for holding fast swimming livebaits who love to flee the net at the last moment. This is reliably prevented by the high walls.

Code	Length	Width
7515 004	100 cm	100 cm



**Bait Fish Sinker**

With folding frame, mesh size: 5mm.

Code	Length	Width
7515 001	100 cm	100 cm



**Wire Landing Net, oval**

Self-supporting.

Code	Ø	Height	Mesh
7009 001	35 cm	40 cm	10 x 10 mm



**Wire Landing Net, round**

Code	Ø	Height	Mesh
7009 002	33 cm	45 cm	12 x 12 mm



**Baitfish and Crab Trap**

Any angler who catches his own baitfish and crabs cannot fail to be impressed by that net. There are two ways in - but no way out for the bait. The bait is stored in a small bag with zip fastener where it can be kept without being eaten.

Code	Model	Length	Ø	Mesh
7001 001	round	60 cm	30 cm	5 x 5 mm

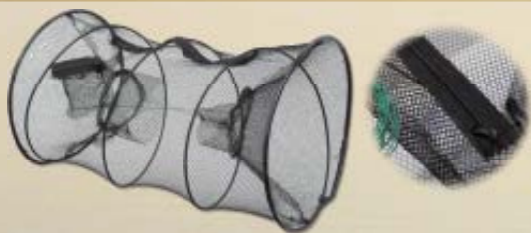

**Baitfish and Crab Trap**

Any angler who catches his own baitfish and crabs cannot fail to be impressed by that net. There are two ways in - but no way out for the bait. The bait is stored in a small bag with zip fastener where it can be kept without being eaten.

Code	Model	Length	Ø	Mesh
7001 002	square	44 cm	26	4 x 4 mm

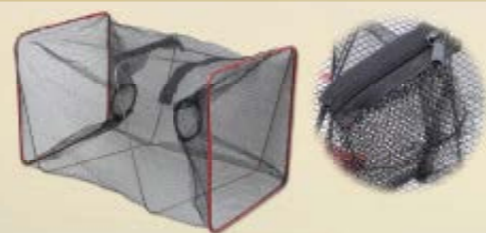

**Cool Sinking Stick**

Extremely robust fibreglass sinking stick, three-piece with screw in eye. Also usable as a landing net handle when eye is removed.

Code	Length
7144 300	3,00 m



**Gaff, two-piece**

Pointed gaff with stainless steel hook and silicon protection cap for transport. Two-piece telescopic aluminium handle.

Code	Length
7051 001	1,50 m



**Deluxe Butt Pad**

Supports your rod while playing your fish. High resistance plastic, very strong belt, rotating base for cross-end handle.

Code
7052 002







**Carbine Swivel**

Brass, burnished.

Code	Length	Size	BS	Content
6113 002	50 mm	2	17 kg	6 pcs
6113 004	47 mm	4	15 kg	8 pcs
6113 006	41 mm	6	13 kg	8 pcs
6113 008	30 mm	8	9 kg	8 pcs
6113 010	32 mm	10	9 kg	6 pcs
6113 012	26 mm	12	7 kg	10 pcs
6113 014	25 mm	14	6 kg	10 pcs
6113 016	22 mm	16	5 kg	6 pcs
6113 018	21 mm	18	4 kg	10 pcs
6113 020	20 mm	20	3 kg	10 pcs

Trade Pack 10 Pieces



**Safety Swivel**

Brass, burnished, round.

Code	Length	Size	BS	Content
6103 002	50 mm	2	41 kg	6 pcs
6103 004	47 mm	4	25 kg	6 pcs
6103 006	41 mm	6	18 kg	8 pcs
6103 008	35 mm	8	14 kg	8 pcs
6103 010	32 mm	10	14 kg	10 pcs
6103 012	27 mm	12	15 kg	10 pcs
6103 014	25 mm	14	12 kg	10 pcs

Trade Pack 10 Pieces



**Double Swivel**

Brass, burnished, round.

Code	Length	Size	BS	Content
6101 004	70 mm	4	15 kg	10 pcs
6101 006	62 mm	6	13 kg	6 pcs
6101 008	51 mm	8	9 kg	10 pcs
6101 010	48 mm	10	9 kg	10 pcs
6101 012	39 mm	12	7 kg	10 pcs
6101 014	38 mm	14	6 kg	10 pcs
6101 016	33 mm	16	5 kg	10 pcs

Trade Pack 10 Pieces



**Three Way Swivel**

With a snap in.

Code	Length	Size	BS	Content
6106 010	61 mm	10	15 kg	8 pcs
6106 012	52 mm	12	10 kg	10 pcs
6106 014	48 mm	14	8 kg	10 pcs
6106 016	43 mm	16	6 kg	10 pcs
6106 018	38 mm	18	4 kg	10 pcs
6106 020	37 mm	20	4 kg	10 pcs

Trade Pack 10 Pieces



**Safety Swivel**

Brass, burnished, round.

Code	Length	Size	BS	Content
6128 006	49 mm	6	36 kg	5 pcs
6128 008	41 mm	8	30 kg	5 pcs
6128 010	34 mm	10	28 kg	5 pcs
6128 012	30 mm	12	23 kg	5 pcs

Trade Pack 10 Pieces



**Sea Swivel**

Brass, chrome-plated, with ball bearings.

Code	Length	Size	BS	Content
6162 022	22 mm	22	20 kg	5 pcs
6162 032	32 mm	32	25 kg	5 pcs
6162 042	42 mm	42	36 kg	5 pcs
6162 052	52 mm	52	40 kg	3 pcs
6162 072	60 mm	60	55 kg	3 pcs

Trade Pack 10 Pieces



**Clover Swivel**

Brass, polished.

Code	Length	Width	Size	BS	Content
6150 004	24 mm	15 mm	4	22 kg	8 pcs
6150 006	22 mm	13 mm	6	19 kg	10 pcs
6150 008	19 mm	12 mm	8	17 kg	10 pcs
6150 010	16 mm	12 mm	10	15 kg	10 pcs
6150 012	14 mm	9 mm	12	12 kg	10 pcs

Trade Pack 10 Pieces



**Snap-Links**

Suspension carbines.

Code	Length	Size	BS	Content
6126 006	24 mm	6	35 kg	4 pcs
6126 008	21 mm	8	32 kg	8 pcs
6126 010	17 mm	10	28 kg	10 pcs

Trade Pack 10 Pieces



**Energy Safety Swivel**

Brass with extra strong steel coupler.

Code	Length	Size	BS	Content
6129 100	73 mm	1/0	65 kg	10 pcs
6129 002	60 mm	2	43 kg	6 pcs
6129 004	50 mm	4	35 kg	6 pcs
6129 006	47 mm	6	32 kg	10 pcs
6129 008	38 mm	8	25 kg	10 pcs

Trade Pack 10 Pieces



**Arched Swivel**

Brass, burnished.

Code	Length	Size	BS	Content
6102 002	28 mm	2	40 kg	10 pcs
6102 004	24 mm	4	25 kg	10 pcs
6102 006	22 mm	6	19 kg	10 pcs
6102 008	19 mm	8	17 kg	10 pcs
6102 010	16 mm	10	15 kg	10 pcs
6102 012	14 mm	12	12 kg	10 pcs
6102 014	12 mm	14	10 kg	10 pcs
6102 016	11 mm	16	8 kg	10 pcs
6102 018	10 mm	18	7 kg	10 pcs

Trade Pack 10 Pieces



**Knotless-connector**

Code	Length	BS	Content
6154 001	15 mm	8 kg	10 pcs
6154 002	18 mm	12 kg	10 pcs
6154 003	24 mm	25 kg	10 pcs

Trade Pack 10 Pieces



**Spring Ring**

Nickel-coated.

Code	Length	BS	Content
6212 006	6 mm	5 kg	15 pcs
6212 008	8 mm	9 kg	15 pcs
6212 010	10 mm	11 kg	10 pcs
6212 012	12 mm	16 kg	10 pcs
6212 014	14 mm	29 kg	10 pcs

Trade Pack 10 Pieces



**Hook Swivel**

Nickel coated.

Code	Length	Size	BS	Content
6120 001	25 mm	1	10 kg	10 pcs
6120 002	31 mm	2	15 kg	10 pcs
6120 003	37 mm	3	20 kg	10 pcs
6120 004	45 mm	4	25 kg	10 pcs

Trade Pack 10 Pieces



**Rolling Swivel**

With safety carbine.

Code	Length	Size	BS	Content
6125 004	31 mm	4	35 kg	6 pcs
6125 006	30 mm	6	35 kg	6 pcs
6125 008	29 mm	8	28 kg	7 pcs
6125 010	28 mm	10	28 kg	6 pcs
6125 012	25 mm	12	20 kg	8 pcs
6125 014	24 mm	14	20 kg	8 pcs
6125 016	20 mm	16	18 kg	8 pcs
6125 018	19 mm	18	12 kg	8 pcs
6125 020	16 mm	20	9 kg	8 pcs

Trade Pack 10 Pieces



**Ball Bearing Swivel, knotless**

Code	Length	Size	BS	Content
6119 002	4,3 cm	2	20 kg	5 pcs
6119 004	5,6 cm	4	35 kg	5 pcs
6119 006	7,6 cm	6	50 kg	3 pcs

Trade Pack 10 Pieces



**Method Connector Swivel**

Quick change connection for method angling.

Code	Length	Content
6123 002	15 mm	3 pcs

Trade Pack 10 Pieces



in addition the following swivels are available from Zebco Europe:

**Quick Change Swivel**

Special swivels for waggler rigs. In this version, the line is threaded into a link with a SIC inlay.

Code	Length	Size	Content
6143 001	22 mm	small	5 pcs
6143 002	24 mm	medium	5 pcs

Trade Pack 10 Pieces



**Easy Swap Swivel**

Practical side mounting system with ready-positioned line stops. Simply tie on and away you go! e.g. for use with wagglers.

Code	Length	Content
6147 001	27 mm / 17 mm	5 pcs

Trade Pack 10 Pieces



**Instant Snap Swivel**

Link swivels for a multitude of uses including quick-changing swimfeeders, bombs etc.

Code	Length	Content
6147 002	22 mm / 17 mm	5 pcs

Trade Pack 10 Pieces



**Dual Lock Snap Top Grade w Rolling Sw**

Code	Length	Size	BS	Content
6111 100	40 mm	1/0	41 kg	7 pcs
6111 002	34 mm	2	32 kg	8 pcs
6111 004	30 mm	4	23 kg	10 pcs
6111 006	19 mm	6	14 kg	10 pcs

Trade Pack 10 Pieces



**Dual Lock Snap Top Grade**

Code	Length	Size	BS	Content
6112 002	20 mm	2	32 kg	8 pcs
6112 004	16 mm	4	23 kg	10 pcs
6112 006	14 mm	6	14 kg	10 pcs

Trade Pack 10 Pieces



**Magic Trout Swivel**

Code	Length	Size	BS	Content
6117 010	25 mm	10	10 kg	10 pcs
6117 012	22 mm	12	7 kg	10 pcs

Trade Pack 10 Pieces



**Quick Clip, extra strong**

Code	Length	BS	Content	Colour
6121 009	9 mm	4 kg	10 pcs	black dull

Trade Pack 10 Pieces



**Dual lock snap, extra strong**

Code	Length	BS	Content	Colour
6122 008	8 mm	4 kg	10 pcs	black dull
6122 010	10 mm	9 kg	10 pcs	black dull
6122 012	12 mm	12 kg	10 pcs	black dull
6122 015	15 mm	18 kg	10 pcs	black dull
6122 017	17 mm	25 kg	10 pcs	black dull
6122 020	20 mm	30 kg	10 pcs	black dull

Trade Pack 10 Pieces



**Treble Swivel, High Speed**

Code	Length	Size	BS	Content
6132 008	17 mm	8	20 kg	7 pcs
6132 010	15 mm	10	14 kg	10 pcs
6132 012	13 mm	12	9 kg	10 pcs
6132 014	11 mm	14	5 kg	10 pcs

Trade Pack 10 Pieces



**Bent Head Oval Split Ring**

Code	Length	Size
6110 001	13 mm	4

Trade Pack 10 Pieces



**Heli Swivel**

Code	Length	Size	Content
6118 007	15 mm	7	7 pcs

Trade Pack 10 Pieces



**Godzilla Swivel**

Extremely strong cross-lock swivel for spinning anglers in small sizes and dead-baiting anglers in the larger sizes. This swivel type is regarded as the ultimate among catfish anglers.

Code	Length	Size	BS	Content
6156 200	55 mm	2/0	50 kg	5 pcs
6156 300	62 mm	3/0	60 kg	5 pcs
6156 400	72 mm	4/0	70 kg	4 pcs

Trade Pack 10 Pieces

**Fast Change X-Strong Cross-lock Snap**

Ultra-strong Crosslock with quick-change option. The lure and leader can be quickly screwed in without even opening the swivel.



Code	Length	BS	Content	Colour
6199 010	10 mm	17 kg	10 pcs	black dull
6199 012	12 mm	28 kg	10 pcs	black dull
6199 015	15 mm	39 kg	10 pcs	black dull
6199 025	25 mm	54 kg	10 pcs	black dull

Trade Pack 10 Pieces



**Rolling Swivel**

Code	Length	Size	Content
6124 003	17 mm	3	10 pcs
6124 004	15 mm	4	10 pcs
6124 005	14 mm	5	10 pcs

Trade Pack 10 Pieces

**Black Cat Power Snap**

Special snap link for quick rig changes of leaders and spinners.

Code	Length	Size	BS	Content
6155 100	22 mm	1/0	30 kg	10 pcs
6155 200	28 mm	2/0	40 kg	10 pcs
6155 300	31 mm	3/0	50 kg	10 pcs

Trade Pack 10 Pieces



**HD 3 way swivle**

Code	Length	BS	Content
6172 001	80 mm	100 kg	1 pcs

Trade Pack 10 Pieces







**Heavy Duty Cross Lock Swivel**

Code	Length	Size	BS	Content
6173 100	52 mm	1/0	55 kg	5 pcs
6173 300	60 mm	3/0	70 kg	5 pcs
6173 400	65 mm	4/0	100 kg	3 pcs

Trade Pack 10 Pieces



**Catfish Rolling Swivel**

Code	Length	Size	BS	Content
6174 400	33 mm	3/0	135 kg	5 pcs
6174 600	35 mm	6/0	170 kg	5 pcs

Trade Pack 10 Pieces



**Ball Bearing Swivel**

Code	Length	Size	BS	Content
6175 001	40 mm	1	175 kg	2 pcs
6175 002	36 mm	2	135 kg	3 pcs
6175 004	36 mm	4	90 kg	3 pcs
6175 005	32 mm	5	65 kg	5 pcs

Trade Pack 10 Pieces



**Split Shot Assortment 70g, fine**

Code	Contents
6000 900	70 g

Trade Pack 10 Pieces



**Split Shot Assortment 100g, fine**

Code	Contents
6000 901	100 g

Trade Pack 10 Pieces



**Split Shot Assortment 100g, coarse**

Code	Contents
6000 902	100 g

Trade Pack 10 Pieces



**Allround Swivel Assortment**

Code	Content
6100 003	100 pcs

Trade Pack 10 Pieces



**Split Ring Assortment**

Code	Content
6100 001	100 pcs

Trade Pack 10 Pieces



**Split Shot Assortment 170g, oval**

Code	Contents
6000 904	170 g

Trade Pack 10 Pieces



**Lead Bead with Tube**

Code	Content
6073 901	76 pcs

Trade Pack 10 Pieces

Assorted, 7 sizes from 0.5g - 2.5g, contents: 76 pcs



**Lead Bead with Tube**

Code	Content
6073 902	60 pcs

Trade Pack 10 Pieces

Assorted, 7 sizes from 2.0g - 5.0g, contents: 60 pcs







**Code** 6073 904  
**Content** 35 pcs  
Trade Pack 10 Pieces

**Lead Bead with Tube**

Assorted, 7 sizes from 3.0g – 8.0g, contents: 35 pcs



**Code** 6074 901  
**Content** 35 pcs  
Trade Pack 10 Pieces

**Lead Bead with Tube**

Assorted, 7 sizes from 1.5g – 6.0g, contents: 35 pcs



**Code** 6074 902  
**Content** 50 pcs  
Trade Pack 10 Pieces

**Lead Bead with Tube**

Assorted, 7 sizes from 1.0g – 5.0g, contents: 50 pcs



**Code** 6073 903  
**Content** 140 pcs  
Trade Pack 10 Pieces

**Lead Bead with Tube**

Assorted, 11 sizes from 1.0g - 13.0g, content: 140 pcs



**Code** 6000 903  
**Contents** 150 g  
Trade Pack 10 Pieces

**Ball Lead**

Assortment of 7 sizes from 0.5 to 5g. Contents: 150 g.



**Herring Lead**

In packs of 10.

Code	Weight	Content
6056 020	20 g	1 pcs
6056 030	30 g	1 pcs
6056 040	40 g	1 pcs
6056 050	50 g	1 pcs
6056 060	60 g	1 pcs

Trade Pack 10 Pieces



**Herring Lead, lead free**

Lead free.

Code	Weight	Content
6056 120	20 g	1 pcs
6056 130	30 g	1 pcs
6056 140	40 g	1 pcs
6056 150	50 g	1 pcs
6056 160	60 g	1 pcs

Trade Pack 10 Pieces



**Surf Lead**

With fold-back claws.

Code	Weight
6079 080	80 g
6079 100	100 g
6079 125	125 g
6079 150	150 g
6079 170	170 g
6079 190	190 g

Trade Pack 10 Pieces



**Surf Weight, lead free**

With fold-back claws.

Code	Weight
6025 081	80 g
6025 101	100 g
6025 126	125 g
6025 151	150 g
6025 171	170 g
6025 191	190 g

Trade Pack 10 Pieces



**Surf Weight, lead free**

Now also available in a lead-free version!

Code	Weight	Content
6083 101	100 g	1 pcs
6083 121	120 g	1 pcs
6083 141	140 g	1 pcs
6083 161	160 g	1 pcs
6083 181	180 g	1 pcs
6083 201	200 g	1 pcs

Trade Pack 10 Pieces



**Surf Lead**

For medium wind strengths

Code	Weight
6083 100	100 g
6083 120	120 g
6083 140	140 g
6083 160	160 g
6083 180	180 g
6083 200	200 g

Trade Pack 10 Pieces







**Swivel Pear Lead**

Self service pack.

Code	Weight	Content
6041 003	3 g	3 pcs
6041 005	5 g	3 pcs
6041 007	7 g	3 pcs
6041 010	10 g	3 pcs
6041 015	15 g	3 pcs
6041 020	20 g	3 pcs
6041 025	25 g	3 pcs
6041 030	30 g	2 pcs
6041 035	35 g	2 pcs
6041 040	40 g	2 pcs
6041 050	50 g	1 pcs
6041 060	60 g	1 pcs
6041 080	80 g	1 pcs
6041 100	100 g	1 pcs
6041 150	150 g	1 pcs
6041 200	200 g	1 pcs
6041 250	250 g	1 pcs
6041 300	300 g	1 pcs

Trade Pack 10 Pieces



**Lead Ball**

Self service pack.

Code	Weight	Content
6011 001	1 g	12 pcs
6011 002	2 g	12 pcs
6011 003	3 g	12 pcs
6011 005	5 g	12 pcs
6011 008	8 g	10 pcs
6011 010	10 g	8 pcs
6011 012	12 g	7 pcs
6011 020	20 g	5 pcs

Trade Pack 10 Pieces



**Barrel Lead**

In packs.

Code	Weight	Content
6023 003	3 g	10 pcs
6023 006	6 g	6 pcs
6023 009	9 g	4 pcs
6023 012	12 g	3 pcs
6023 015	15 g	3 pcs
6023 020	20 g	3 pcs
6023 030	30 g	3 pcs
6023 040	40 g	3 pcs

Trade Pack 10 Pieces



**Clip-On Plummet**

In packs.

Code	Weight	Content
6030 005	5 g	2 pcs
6030 010	10 g	2 pcs
6030 015	15 g	2 pcs
6030 020	20 g	2 pcs
6030 025	25 g	2 pcs
6030 035	35 g	2 pcs

Trade Pack 10 Pieces



**Coffin Lead**

Self service pack.

Code	Weight	Content
6021 010	10 g	5 pcs
6021 015	15 g	4 pcs
6021 020	20 g	3 pcs
6021 025	25 g	3 pcs
6021 030	30 g	2 pcs
6021 035	35 g	2 pcs
6021 040	40 g	2 pcs
6021 050	50 g	2 pcs
6021 060	60 g	2 pcs
6021 070	70 g	1 pcs
6021 080	80 g	1 pcs
6021 100	100 g	1 pcs

Trade Pack 10 Pieces



**Clip-On Cork Plummet**

With foam insert in self service pack.

Code	Weight	Content
6031 005	5 g	3 pcs
6031 010	10 g	3 pcs
6031 015	15 g	3 pcs
6031 020	20 g	3 pcs

Trade Pack 10 Pieces



**Stand Up Lead**

Stand-up lead for bottom fishing.

Code	Weight
6020 005	5 g
6020 010	10 g
6020 015	15 g
6020 020	20 g
6020 025	25 g
6020 030	30 g
6020 035	35 g
6020 040	40 g
6020 050	50 g
6020 060	60 g
6020 080	80 g
6020 100	100 g

Trade Pack 10 Pieces



**Lead-free Jig Head "Sea"**

Code	Hook Size	Weight	Content
3130 060	8/0	60 g	2 pcs
3130 080	8/0	80 g	2 pcs
3130 100	8/0	100 g	2 pcs

Trade Pack 10 Pieces



**Lead-free Jig Head**

Code	Hook Size	Weight	Content
3131 015	10/0	15 g	2 pcs
3131 020	10/0	20 g	2 pcs

Trade Pack 10 Pieces



**Jighead, lead free**

Code	Hook Size	Weight	Content
3171 100	4	2 g	5 pcs
3171 101	4	4 g	5 pcs
3171 102	4	6 g	5 pcs
3171 200	1	2 g	5 pcs
3171 201	1	4 g	5 pcs
3171 202	1	6 g	5 pcs
3171 300	1/0	6 g	5 pcs
3171 301	1/0	10 g	5 pcs
3171 302	1/0	14 g	5 pcs
3171 400	2/0	6 g	5 pcs
3171 401	2/0	10 g	5 pcs
3171 402	2/0	14 g	5 pcs
3171 500	3/0	6 g	5 pcs
3171 501	3/0	10 g	5 pcs
3171 502	3/0	14 g	5 pcs
3171 600	5/0	40 g	2 pcs
3171 601	5/0	60 g	2 pcs
3171 700	6/0	80 g	1 pcs
3171 701	6/0	100 g	1 pcs

Trade Pack 10 Pieces





**Split Shot Assortment, lead free**

Code	Content
6191 072	44 pcs

Trade Pack 5 Pieces



**Leadball, lead free**

Code	Weight	Content
6191 001	1,3 g	6 pcs
6191 003	2,7 g	6 pcs
6191 004	4,3 g	6 pcs
6191 007	6,6 g	4 pcs
6191 009	9 g	4 pcs
6191 013	13 g	3 pcs
6191 017	17 g	3 pcs
6191 022	22 g	2 pcs

Trade Pack 10 Pieces



**Pear Lead, lead free**

Code	Weight	Content
6190 010	10 g	1 pcs
6190 014	14 g	1 pcs

Trade Pack 10 Pieces



**Coffin Lead, lead free**

Code	Weight	Content
6193 009	9 g	2 pcs
6193 014	14 g	2 pcs
6193 022	21,7 g	2 pcs

Trade Pack 10 Pieces



**Clip on Plummet, lead free**

Code	Weight	Content
6192 007	7 g	2 pcs
6192 009	9 g	2 pcs

Trade Pack 10 Pieces



**Cork Plummet, lead free**

Code	Weight	Content
6194 009	9 g	2 pcs
6194 014	14 g	2 pcs
6194 020	20 g	2 pcs

Trade Pack 10 Pieces



**Olive Lead, lead free**

Code	Weight	Content
6195 004	4 g	6 pcs
6195 006	6 g	6 pcs
6195 008	8 g	6 pcs

Trade Pack 10 Pieces



**Stand Up Sinkers**

Code	Weight	Content	Colour
6042 020	20 g	1 pcs	black
6042 040	40 g	1 pcs	black
6042 060	60 g	1 pcs	black

Trade Pack 10 Pieces



**Match Feeder**

Oval, self service pack.

Code	Weight
6643 001	20 g
6643 002	40 g
6643 003	60 g

Trade Pack 10 Pieces

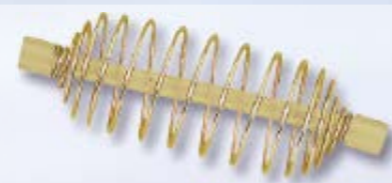

**Coil Feeder**

Feeder coil with plastic inner. Self service pack.

Code	Length
6641 001	6 cm
6641 002	7 cm
6641 003	8 cm

Trade Pack 10 Pieces



**Weighted Coil Feeder**

Feeder coil with leaded inner. Self service pack.

Code	Weight
6647 001	20 g
6647 002	30 g
6647 003	40 g

Trade Pack 10 Pieces



**Feeder Booms**

In packs of 3.

Code	Length
6615 004	5 cm
6615 010	10 cm
6615 030	30 cm

Trade Pack 10 Pieces



**Feeder boom strong**

Ultra-robust boom. The heavy-duty plastic does not break, even when using heavy weights.

Code	Length
6617 006	7 cm
6617 007	10 cm
6617 008	12 cm
6617 009	18 cm

Trade Pack 10 Pieces



**Feeder Booms**

Distance booms, particularly designed for sea fishing. 3 items on header card.

Code	Length
6617 001	5 cm
6617 002	10 cm
6617 003	15 cm
6617 004	20 cm

Trade Pack 10 Pieces



**Casting Boom**

Code	Length	Content
6615 001	15 cm	3 pcs
6615 002	25 cm	3 pcs

Trade Pack 10 Pieces



**Maggot Catapult**

Code	Size
9915 002	L

Trade Pack 10 Pieces



**Feed Catapult**

Code
9915 000

Trade Pack 10 Pieces



**Hook Tier**

For quick and reliable hook tying. Self service pack.

Code
6335 000

Trade Pack 10 Pieces



**Sharpening Stone**

For sharpening all standard hooks. 1 item on a header card.

Code	Content
9701 001	1 pcs

Trade Pack 10 Pieces



**Boilie needle**

Code	Model	Length
6602 001	with fold-away eye	5 cm
6602 002	straight	11 cm

Trade Pack 10 Pieces



**Boilie Drill**

Boilie drill with protective cover in pack. In packs.

Code
6601 000

Trade Pack 10 Pieces



**Rig Tensioner**

Plastic, for 20 rigs. With spring tensioning. Self service pack

Code
6780 000

Trade Pack 10 Pieces





**Rig Holder**

Plastic, for 20 rigs. Size: 8 x 18cm. Self service pack.

Code	Width	Height
6782 000	8 cm	18 cm

Trade Pack 10 Pieces

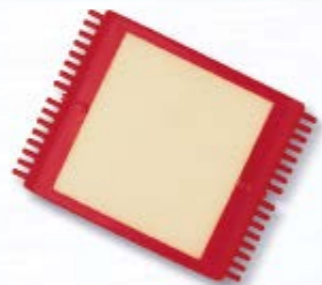

**Rig Holder**

With particularly soft yet tough foam. Self service pack. Size: 9x7cm.

Code	Width	Height
6781 000	9 cm	7 cm

Trade Pack 10 Pieces



**Fish Scaler**

Round, Self service pack.

Code	Length
6327 001	22 cm

Trade Pack 10 Pieces



**Fish Scaler**

Stable design. The rubber handle guarantees safe operation. Length 22 cm. Self service pack.

Code
6327 000

Trade Pack 10 Pieces



**Pike Gag**

Self service pack.

Code	Length
6302 018	18 cm

Trade Pack 10 Pieces



**Leader Holder**

With shock proof cork cover. Self service pack.

Code	Width	Height
6780 001	9 cm	6 cm

Trade Pack 10 Pieces



**Cosmos Bite Alarm Set**

Value-for-money radio bite alarm set with three bite alarms and a radio box. Never miss another bite during the night even if you do not want to sit right next to your rods. Maximum range, depending on conditions: 90m.

Code	Content
6804 999	3+1 pcs



**Cosmos Bite Alarm**

Single bite alarm in proven design and robust quality. Can be connected to the radio receiver of the Cosmos Bite Alarm Set. Maximum range, depending on conditions: 90m. Batteries: 1x9V (not included).

Code	Content
6804 001	1 pcs



**Spark Bite Alarm**

With adjustable buttons for volume, pitch and sensitivity. Finished with spraywater-resistant housing, ultra-bright LEDs, nightlight function, sounder box connection and stainless steel thread. Batteries: 1x9V (not included).

Code
6805 016

Trade Pack 3 Pieces



**Echo Bite Alarm**

Electronic bite alarm. Two adjustable buttons for volume, pitch and sensitivity with display. Finished with spraywater-resistant housing, ultra-bright LEDs and stainless steel thread. Bite alarm operated by 9V block battery (not supplied).

Code
6805 017

Trade Pack 3 Pieces



**Triton AX Bite Alarm**

Features: Water resistant · Volume and tone controls · Highly visible LEDs · One Extension Socket · Matt soft touch finish · High Output Speaker · Rigid Adjustment Thread. Batteries: 1x9V (not included).

Code	Weight
6805 018	85 g

Trade Pack 5 Pieces



**Atac AC Bite Alarm**

Features: Volume Control (3 level) · Tone Control (8 level) · Highly visible LEDs · Afterglow Function (25sec) · Water resistant Batteries: 3xAAA (not included).

Code	Weight
6805 019	80 g

Trade Pack 5 Pieces





**Folding Knife**

- Jackknife with stainless steel blade
- Real wood handle
- Safety catch
- Blade length 7cm

**Code**    **Length**  
6524 001    7 cm  
Trade Pack 20 Pieces



**Folding Knife**

- Jackknife with stainless steel blade
- Ergonomic metal handle
- Safety catch
- Blade length 7cm

**Code**    **Length**  
6524 002    7 cm  
Trade Pack 20 Pieces



**Stainless Steel Unhooking Pliers**

Proven design, produced in stainless steel. Now even sea anglers do not need to worry about leaving this effective hook remover lying around wet on board.

**Code**    **Length**  
6402 005    24 cm  
Trade Pack 5 Pieces



**Filleting Knife**

Steel blade. Self service pack.

**Code**    **Length**  
6522 000    13 cm  
Trade Pack 5 Pieces



**Diamant Hook Sharpener**

Indispensable aid for making blunt hooks sharp again.

**Code**    **Length**  
9701 003    10 cm  
Trade Pack 5 Pieces

**Forcep**

Self service pack.

Code	Length
6401 013	13 cm
6401 015	15 cm
6401 018	18 cm
6401 020	20 cm
6401 025	25 cm

Trade Pack 5 Pieces



**Crimping Plier**

Outstanding quality for precision crimping of steel, titanium or hard monofilament leaders. Suitable for steel and brass crimp sleeves of 0.6 mm to 3.9 mm diameter.

**Code**  
6403 005  
Trade Pack 5 Pieces



**Crimping Plier**

Very practical for DIY crimping of steel traces. Supplied with a starter set containing 100 crimps in 5 diameters.

**Code**  
6403 000  
Trade Pack 5 Pieces



**Power Lifter Scale**

Electronic scales with ergonomically designed handle. The Power Lifter Scale can handle loads of up to 50kg meaning even large catfish can be weighed without a problem. Batteries: 1xCR (not included).

**Code**    **Interval**  
9890 012    5 g



**Digital Pocket Scale**

Handy digital scales with easy to read display. Weighing Range: 0-40 kg. Batteries: 2xAAA (not included).

**Code**    **Interval**  
9890 003    5 g





**Spring Scale**

De Luxe version up to 22kg with scale adjustment and 1m measuring tape

**Code**  
9890 000  
Trade Pack 5 Pieces



**Priest**

Made of wood with brass head. 18cm and 22cm.

Code	Length
6326 018	18 cm
6326 022	22 cm

Trade Pack 5 Pieces



**Priest**

Made of wood

Code	Length
6326 001	36 cm

Trade Pack 5 Pieces



**Disgorger, Plastic**

Material: Plastic

Code	Length
6320 002	15 cm
6320 003	17 cm

Trade Pack 10 Pieces



**Disgorger, Plastic**

Material: Plastic

Code	Content
6322 000	2 pcs

Trade Pack 10 Pieces



**Disgorger, brass**

Disgorger, match in packs of 2. Material: brass

Code	Content
6323 000	2 pcs

Trade Pack 10 Pieces



**Disgorger, Plastic**

With priest length 20cm.

Code	Length
6325 000	20 cm

Trade Pack 10 Pieces



**Special Steel Threader**

in pack

Code	Length
6601 003	13 cm

Trade Pack 10 Pieces



**Special Steel Boilie Needle**

in pack

Code	Length
6601 004	7 cm

Trade Pack 10 Pieces



**Steel Boilie Needle**

with fold away eye in pack

Code	Length
6601 005	12 cm

Trade Pack 10 Pieces



**Steel Boilie Needle**

with fold away eye in pack

Code	Length
6601 006	16 cm

Trade Pack 10 Pieces



**Special Steel Boilie Needle**

in pack

Code	Length
6601 007	16 cm
6601 008	11 cm

Trade Pack 10 Pieces



**Lead Core Needle**

Indispensable aid for threading a loop rig in Lead-core line. In self-service pack.

Code	Length
6601 009	7 cm

Trade Pack 10 Pieces



**Bait Needle w. Fold-away line eye**

Fold-away line eye.

Code	Length	Content
6251 000	12 cm	2 pcs

Trade Pack 10 Pieces



**Special Steel Worm Needle**

Brass worm needle, 20 cm, in packs of 2

Code	Length	Content
6253 020	20 cm	2 pcs

Trade Pack 10 Pieces



**Special Steel Worm Needle**

Stainless steel bait needle in perfect quality and adequate length, highly durable bait needles in brass.

Code	Length
6251 002	30 cm

Trade Pack 10 Pieces



**Bait Needle**

Code	Length	Content
6251 001	20 cm	2 pcs

Trade Pack 10 Pieces



**Eel Killer**

1 per pack

Code	Content
6324 000	1 pcs

Trade Pack 5 Pieces





**Trophy Light**

Proven snaplight quality, 4.5 mm diameter

Code	Length	Ø	Content
5531 001	3,7 cm	4,5 mm	2 pcs

Trade Pack 50 Pieces



**Trophy Clip on Light**

Snaplight for clipping directly onto the rod tip. Available in two different diameters.

Code	Model	Length	Ø	Content
5531 002	L	5 cm	2,7 mm / 3,2 mm	1 pcs
5531 003	XL	5 cm	3,7 mm	1 pcs

Trade Pack 50 Pieces



**Trophy Bubble Stick**

Snaplight with thickened head for better visibility, e.g. for use on snaplight floats.

Code	Model	Length	Ø	Content
5531 004	red	3,7 cm	4,5 mm	1 pcs
5531 005	green	3,7 cm	4,5 mm	1 pcs

Trade Pack 50 Pieces



**Rubber Light Holder**

2 pieces in pack, 5596 003: for 3.0mm lights, tip diameters up to 2.8mm. 5596 004: for 4.5mm lights, tip diameters up to 4.5mm. Material: rubber

Code	Model	Size	Content
5596 003	Medium	M	2 pcs
5596 004	Large	L	2 pcs

Trade Pack 10 Pieces



**Suspended Bite Indicator**

For night time, in bags of 2.

Code	Content
6711 002	2 pcs

Trade Pack 10 Pieces



**Suspended Bite Indicator**

phosphorescent

Code	Content
6711 000	2 pcs

Trade Pack 50 Pieces



**Light Holder**

Is simply clamped onto the tip of the rod, in packs of 2.

Code	Model	Size	Content
5596 001	Medium	M	2 pcs
5596 002	Large	L	2 pcs

Trade Pack 10 Pieces



**Eel Bell**

Chrome plated, screw-on, with light adapter. Material: chrome

Code	Model	Content
6708 000	bulk	1 pcs
6708 001	in pack	2 pcs

Trade Pack 10 Pieces



**Eel bell**

BigBell

Code	Model	Content
6701 003	bulk	1 pcs
6701 001	in pack	2 pcs

Trade Pack 10 Pieces



**Eel Bell**

Chrome plated with wide clamp. Material: chrome

Code	Model	Content
6707 000	bulk	1 pcs
6703 000	in pack	2 pcs

Trade Pack 10 Pieces



**Eel Bell**

Brass, with pointed clamp. Material: brass

Code	Model	Content
6700 000	bulk	1 pcs
6701 000	in pack	2 pcs

Trade Pack 10 Pieces



**Double Bell**

Chrome plated, with spiral spring and butterfly clamp. Material: brass

Code	Model	Content
6710 000	bulk	1 pcs
6710 001	in pack	2 pcs

Trade Pack 10 Pieces



**Bead Stopper**

5 beads per pack.

Code	Model	Content
3166 001	mini	5 pcs
3166 003	medium	5 pcs
3166 004	assorted	5 pcs
3166 005	large	5 pcs

Trade Pack 10 Pieces



**Silicone Bung**

6 per header card.

Code	Model	Size	Content
3163 001	SSS	SSS	6 pcs
3163 002	SS	SS	6 pcs
3163 003	S	S	6 pcs
3163 004	L	L	6 pcs
3163 005	XL	XL	6 pcs

Trade Pack 10 Pieces



**Rubber Stopper**

In packs of 15.

Code	Model	Content
3164 001	mini	15 pcs
3164 002	medium	15 pcs
3164 003	large	15 pcs
3164 000	assorted	15 pcs

Trade Pack 10 Pieces





**Silicone Stopper**

In packs of 15.

Code	Model	Content
3164 008	micro	15 pcs
3164 005	mini	15 pcs
3164 006	medium	15 pcs
3164 007	large	15 pcs
3164 004	assorted	15 pcs
3164 009	x-large	15 pcs

Trade Pack 10 Pieces



**Rubber Bead**

10 pieces on a header card

Code	Ø	Content
6611 004	4 mm	10 pcs
6611 006	6 mm	10 pcs
6611 008	8 mm	10 pcs

Trade Pack 10 Pieces



**Tip Light Set**

Set of three rod tip bite indicators. Used instead of snap lights and can be easily fitted onto the rod tip. Visible from long distances. Low power consumption. Batteries supplied.

Code	Content
6805 005	3 pcs

Trade Pack 10 Pieces



**Outdoor lamp**

Versatile outdoor lamp for night sessions, etc. with 20 mini-LEDs and three standard LEDs. With a magnet or hook for hanging, e.g. from an umbrella. Batteries: 3xAAA (not included).

Code	Weight
9892 001	65 g



**Rubber Bead Assortment**

Rubber beads and leger beads in a practical box.

Code
3169 017

Trade Pack 10 Pieces



**Bead Assortment**

Code	Length
3168 000	2 - 8 mm
3168 001	2 - 3 mm

Trade Pack 10 Pieces

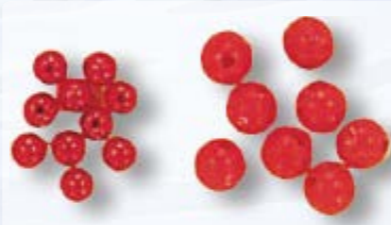

**Stopper Bead**

In packs of 25

Code	Length	Content
3168 004	4 mm	25 pcs
3168 006	6 mm	25 pcs
3168 008	8 mm	25 pcs

Trade Pack 10 Pieces



**Waterproof head lamp**

Waterproof head torch (up to 1 m range). Ultra-bright thanks to the strong LED. Batteries: 3xAAA (not included).

Code
9892 002



**Floater**

Highly versatile floating device.

Code	Length	Width	Content
3167 001	8 mm	4,3 mm	6 pcs
3167 002	11 mm	5,6 mm	6 pcs
3167 003	18,5 mm	8,8 mm	6 pcs
3167 004	26 mm	11,5 mm	6 pcs

Trade Pack 10 Pieces



**Floater**

Highly versatile floating device.

Code	Length	Width	Content
3167 011	8 mm	4,3 mm	6 pcs
3167 012	11 mm	5,6 mm	6 pcs
3167 013	18,5 mm	8,8 mm	6 pcs
3167 014	26 mm	11,5 mm	6 pcs

Trade Pack 10 Pieces



**Float sleeves**

Assortment in pack.

Code
5597 001

Trade Pack 10 Pieces



**Sensor LED Headlight 3W**

Luminance: 130 lumen · 2 red LEDs · 1 white main bulb (3 Watt) · Motion Sensor for switching on and off. Batteries: 3xAAA (not included).

Code	Weight
9895 033	82 g



**Pole Float Sleeves**

5 different diameters per pack.

Code	Length
5597 000	0,5 - 2 mm
5597 002	0,5 - 3 mm

Trade Pack 10 Pieces



**Silicone Stopper**

Code	Length	Content	Colour
3153 001	7 mm	12 pcs	white
3153 002	7 mm	12 pcs	pink
3153 003	7 mm	12 pcs	green
3153 004	7 mm	12 pcs	yellow
3153 005	7 mm	12 pcs	red
3153 006	7 mm	12 pcs	orange
3153 007	7 mm	12 pcs	glow

Trade Pack 10 Pieces



**LED-Clip On Light**

• 4 super bright LEDs • 360° Adjustable • 160° vertically adjustable • splash proof • battery compartment with rubber seal. Batteries: 1xCR (not included).

Code
9895 032





### Power LED Head Lamp

No fewer than 17 super bright LEDs provide a flood of light without rival on the market. The diode technology saves energy while the lamp is light to wear. Batteries: 3xAAA (not included).

**Code**  
9895 014



### Power Focus Headlamp

With adjustable focus (near/far), ultra-bright LED (1 Watt) and long battery life. Batteries: 3xAAA (not included).

**Code**  
9895 011



### LED Head Lamp

3 superbright LED lights. Batteries: 3xAAA (not included).

**Code**  
9895 010



### Illuminati Headlamp

Range approx. 30 metres, approx. 7 hours battery life and 80 Lumens light output on the highest setting. Batteries: 3xAAA (not included).

**Code**   **Weight**   **Colour**  
9897 001   80 g   black

**NEW**



### Lumo Stick LED

- 24+1 super bright white LED (0.5W)• Select between 24 LEDs (bright) and 1 Power LED (long distance)• Light weight Aluminium material with soft grip surface• Simple on/off push button• Available in 3 colors Batteries: 4xAAA (not included).

**Code**  
9895 021  
Trade Pack 12 Pieces



### Hat Light

Clever headlamp that can be attached to all normal peaked caps, with speed and ease. The light is supplied with 5 bright diodes and low energy consumption and it is light as a feather.

**Code**  
9895 002  
Trade Pack 5 Pieces



### Wall Rod Holder

Two piece. For organising the angler's cellar.

**Code**  
9702 001  
Trade Pack 5 Pieces



Adjustable.

### Rod Rest

Adjustable.

**Code**  
1847 002  
Trade Pack 10 Pieces





**Rod Rest**

1 per pack, with brass thread.

Code	Model	Content
1849 001	V	1 pcs

Trade Pack 10 Pieces



**Rod Rest**

1 per pack, with brass thread.

Code	Model	Content
1849 002	U	1 pcs

Trade Pack 10 Pieces



**Rod Rest**

1 per pack, with brass thread.

Code	Model	Content
1849 003	Double U	1 pcs

Trade Pack 10 Pieces



**Extending Clip**

For the safe attachment of scissors, disgorgers, etc .

Code
6408 000

Trade Pack 10 Pieces



**V Telescopic Rod Holder**

Code	Length
1821 000	60 - 100 cm
1821 001	45 - 75 cm

Trade Pack 10 Pieces



**Bank Stick**

All bank sticks with English brass thread and rapid adjustment.

Code	Length
1830 001	50 - 90 cm
1830 002	80 - 125 cm
1830 003	100 - 160 cm

Trade Pack 5 Pieces



**Ground Spike**

One piece, light aluminium ground spike.

Code	Length
1835 001	0,60 m
1835 002	0,80 m
1835 003	1,00 m
1835 004	1,20 m

Trade Pack 10 Pieces



**Vario Ground Spike**

Two piece, universally adjustable, light aluminium ground spike.

Code	Length
1836 001	1,10 m
1836 002	1,30 m
1836 003	1,50 m

Trade Pack 5 Pieces



**Folding Rod Holder, metal**

With earth spike, internal dimension: 40mm.

Code
1809 000

Trade Pack 10 Pieces



**Rod Holder**

With screw in ground spike.

Code
1807 000

Trade Pack 10 Pieces



**Rod Holder**

Code	Length
8206 004	54 - 88 cm
8206 005	75 - 128 cm

Trade Pack 5 Pieces



**Rod Holder, folding, extra long**

Code	Length
8206 006	60 cm

Trade Pack 5 Pieces



**Buzzer Bar Set, 2 Rods**

Code	Length
8200 020	20 cm / 25 cm



**V Rod Holder**

Code	Length
1818 050	50 cm
1818 065	65 cm
1818 085	85 cm

Trade Pack 10 Pieces

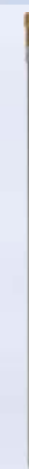

**Bank Stick, stainless steel**

Value-for-money bank sticks in stainless steel - indestructible Zebco quality for everybody. Material: Stainless Steel

Code	Length	Content
8200 010	45 - 75 cm	1 pcs
8200 011	60 - 100 cm	1 pcs
8200 012	100 - 160 cm	1 pcs

Trade Pack 5 Pieces



**Rod Holder**

Angled light metal design. Robust with adjustable lower rod holder. Ideal for beachfishing. The rod holders are made of luminous plastic, allowing the rod to be easily located even in complete darkness.

Code	Length
8205 001	75 cm
8205 002	125 cm

Trade Pack 5 Pieces





**V Tele Rodholder Set**

50 V rod holder in attractive sales display.

Code	Length	Content
1821 999	60 - 100 cm	50 pcs

Trade Pack 50 Pieces



**Tripod Adapter de Luxe**

The tripod is assembled by screwing on the earth spikes. The adapter is shown next to the tripod.

Code
1837 000

Trade Pack 5 Pieces



**Threaded Head**

Adjustable. Ideal for rod rests, landing nets etc. With English brass thread.

Code
1812 001

Trade Pack 5 Pieces



**Telescopic Surf Tripod**

Proven design, height-adjustable tripod, universally applicable, ideal for the beach or pier.

Code
8215 001



**Surf Tripod**

Lightweight, one-piece surf tripod. Outstanding price-performance ratio!

Code
8255 001



**Dark Wader**

Comfortable waders from Zebco in 4.5mm material, keeping the angler reliably warm, even in the most adverse weather conditions. The waders can be continually adjusted for length via a velcro fastener. Overall a comfortable design with robust rubber boots and a firmly gripping treaded sole. Indispensable for spinning and fly anglers as well as carp anglers who often like the choice of waders. Material: 90% Neoprene 10% Poly Jersey. Gram weight: 30 g/m<sup>2</sup>

Code	Size	Colour
9323 040	40/41	grey/black
9323 042	42/43	grey/black
9323 044	44/45	grey/black
9323 046	46/47	grey/black



**Dark Wader Felt Sole**

Comfortable waders from Zebco in 4.5mm material, keeping the angler reliably warm, even in the most adverse weather conditions. The waders can be continually adjusted for length via a velcro fastener. Overall a comfortable design with robust rubber boots and a firmly gripping treaded sole. Indispensable for spinning and fly anglers as well as carp anglers who often like the choice of waders. Material: Neoprene. Gram weight: 30 g/m<sup>2</sup>

Code	Size	Colour
9323 140	40/41	grey/black
9323 142	42/43	grey/black
9323 144	44/45	grey/black
9323 146	46/47	grey/black



**Dark Star Wader**

Waterproof, three-ply technology, durable rubber boots, adjustable belt loops. Material: Polychloride with Polychloride boots. Gram weight: 320 g/m<sup>2</sup>

Code	Size	Content	Colour
9329 040	40	1 pcs	green
9329 042	42	1 pcs	green
9329 043	43	1 pcs	green
9329 044	44	1 pcs	green
9329 045	45	1 pcs	green
9329 046	46	1 pcs	green





**Dark Star Field Boots**

Removable padded inner sole, Thermolite insulation, high grip rubber sole, speed lace hook system, comfort fit, perfect all weather shoe  
Material: upper: suede leather, outsole: TPR, insole: EVA. Gram weight: 320 g/m<sup>2</sup>

Code	Size	Content	Colour
9330 040	40	1 pcs	grey/black
9330 041	41	1 pcs	grey/black
9330 042	42	1 pcs	grey/black
9330 043	43	1 pcs	grey/black
9330 044	44	1 pcs	grey/black
9330 045	45	1 pcs	grey/black
9330 046	46	1 pcs	grey/black



**Dark Star Rubber Boots**

Neoprene beach boots, 3/4 boot, waterproof, comfortable, warm, high grip lightweight sole, great multipurpose fishing boot, light weight  
Material: upper: 4.5 mm neoprene and rubber, outsole: rubber, lining: neoprene, insole: EVA. Gram weight: 320 g/m<sup>2</sup>

Code	Size	Content	Colour
9331 040	40	1 pcs	black
9331 041	41	1 pcs	black
9331 042	42	1 pcs	black
9331 043	43	1 pcs	black
9331 044	44	1 pcs	black
9331 045	45	1 pcs	black
9331 046	46	1 pcs	black



**Dark Star Thermo Boot**

- 3/4 boot- waterproof- comfortable- warm- high grip lightweight sole- great multipurpose fishing boot- light weight- removable extra warm felt lining  
Material: upper: oxford, bottom: TPR, inner: removable felt liner, insole: EVA. Gram weight: 320 g/m<sup>2</sup>

Code	Size	Content	Colour
9332 040	40	1 pcs	black
9332 041	41	1 pcs	black
9332 042	42	1 pcs	black
9332 043	43	1 pcs	black
9332 044	44	1 pcs	black
9332 045	45	1 pcs	black
9332 046	46	1 pcs	black



**Thermo Suit**

Now there is no need to freeze even in the coldest winter: The two-piece Zebco Thermo Suit keeps the angler optimally protected against the cold. The surface material is also waterproof. And all at an unbeatable price-performance ratio. Material: 100% Polyester. Gram weight: 200 g/m<sup>2</sup>

Code	Size
8976 001	M
8976 002	L
8976 003	XL
8976 004	XXL



**Neoprene Gloves**

Comfortable to wear, warm (2.5 mm thick material). Velcro cuffs, fold back thumbs, index and middle fingers when precise work is at hand. Material: 90% Neoprene, 10% Nylon. Gram weight: 4 g/m<sup>2</sup>

Code	Size
9317 001	L
9317 002	XL



**Fur Hat**

Material: mercerized velvet & faux fur. Gram weight: 320 g/m<sup>2</sup>

Code	Size	Content	Colour
9788 060	Uni	1 pcs	black





**Great White™ T-Shirt**

Material: 100% Cotton. Gram weight: 180 g/m²

Code	Size
8975 001	M
8975 002	L
8975 003	XL
8975 004	XXL
8975 005	XXXL



**Great White™ Cap**

Material: 100% Cotton

Code 9788 067

Trade Pack 5 Pieces



**Great White™ Sunglasses**

Stylish sunglasses with polarised effect. An absolute must for all anglers. The sunglasses not only protect the eyes against the sun's rays, they also allow anglers to spot fish in the water that they would otherwise miss thanks to their polarised effect.

Code 8910 011  
Trade Pack 3 Pieces

**Cap**

Zebco Cap Material: 100% Cotton. Gram weight: 222 g/m²

Code 9788 016  
Trade Pack 10 Pieces



**Smoker Chips Beech fine**

Zebco Smoker Chips generate thick smoke and guarantee excellent taste. Only selected woods without any contaminants are used.

Code 9891 010  
Contents 500 g  
Trade Pack 5 Pieces



**Smoker Chips Beech medium**

Zebco Smoker Chips generate thick smoke and guarantee excellent taste. Only selected woods without any contaminants are used.

Code 9891 011  
Contents 500 g  
Trade Pack 5 Pieces



**Smoker Chips Premium coarse**

Zebco Smoker Chips generate thick smoke and guarantee excellent taste. Only selected woods without any contaminants are used.

Code 9891 015  
Contents 500 g  
Trade Pack 5 Pieces



**Great White™ rod stand**

Code	Length	Width	Height
9960 001	60 cm	30 cm	78 cm

Rod stands are delivered without rods.



**Cosmos rod stand**

Code	Length	Width	Height
9960 002	60 cm	30 cm	78 cm

Rod stands are delivered without rods.



**Zebco rod stand**

Code	Length	Width	Height
9963 011	44 cm	25 cm	80 cm



**Rod Display**

Material: wood

Code	Length	Width	Height
9963 009	70 cm	20 cm	70 cm



**Smoke Hook, standard**

Code	Length	Content
6251 010	18 cm	5 pcs

Trade Pack 5 Pieces



**V Smoke Hook**

Code	Length	Content
6251 011	17 cm	5 pcs

Trade Pack 5 Pieces



**Smoke Hook, special**

Code	Length	Content
6251 012	17 cm	5 pcs

Trade Pack 5 Pieces



**Smoke Hook, stainless**

Code	Length	Content
6251 013	27 cm	2 pcs

Trade Pack 5 Pieces







Liver / red      Spicy / red      Vanilla / natural      Strawberry / red  
 Honey / yellow      Scopex / orange      Garlic / red      Mussel / green



**Trophy Sugar Mais**

Tantalising sweetcorn in different colours and flavours. Ready to fish from the tin. This indispensable bait should always be in your seat box as part of your arsenal.

Contents	Liver red	Spicy red	Vanilla natural	Strawberry red	Honey yellow	Scopex orange	Garlic red	Mussel green
125 g	3802 001	3802 002	3802 003	3802 004	3802 005	3802 006	3802 007	3802 008

Trade Pack 12 Pieces



**Sticker Zebco**

Code	Width	Height
9949 040	15 cm	5 cm

Trade Pack 10 Pieces



**Key Straps**

Popular advertising aid with high quality clips.

Code
9949 002

Trade Pack 10 Pieces



**Measure Tape Sticker**

Special high-tech boat sticker with certified seawater resistance. Highly UV-resistant thanks to the use of screen printing. The UV resistance lasts several years depending on use and the intensity of the actual radiation. Material: Polychlorid adhesive film, P4 polyacrylate high-tech adhesive with certified seawater resistance

Code	Width	Height
9949 038	119 cm	12,4 cm

Trade Pack 5 Pieces



**Sticker Set 1**

Quantum Specialist, Radical, Quantum Sea, Quantum, Fin-Nor, Zebco

Code	Width	Height
9949 027	29,7 cm	21 cm

Trade Pack 10 Pieces



**Sticker Set 2**

Black Cat, Browning, Rhino, Rhino Trolling

Code	Width	Height
9949 028	29,7 cm	21 cm

Trade Pack 10 Pieces



**Sticker Zebco**

Code	Width	Height
9971 959	42 cm	10 cm



**Sticker Zebco**

Code	Width	Height
9949 045	12 cm	8 cm

Trade Pack 10 Pieces



**Fishing Licence Folder**

Practical and waterproof – now your fishing licences and other documents are safely protected.

Code
9949 070

Trade Pack 10 Pieces



kompletný cenník na [www.SPORTS.sk](http://www.SPORTS.sk), výhradný distribútor pre SR: SPORTS s.r.o.



**Zebco ECO Bag L**

Material: Paper

Code	Width	Height	Depth
9963 026	340 mm	360 mm	140 mm
Trade Pack 100 Pieces			



**Zebco ECO Bag M**

Material: Paper

Code	Width	Height
9963 025	170 mm	220 mm
Trade Pack 100 Pieces		



**Small Plastic Bag**

Zebco, Quantum, Browning

Code
9963 490
Trade Pack 100 Pieces



**Plastic Bag**

Let's go fishing.

Code
9963 500
Trade Pack 100 Pieces

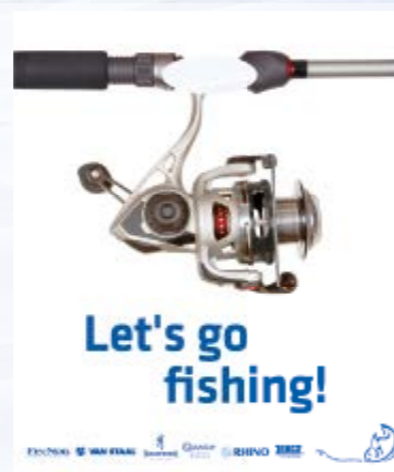

**Pegboard Single Peg**

Code	Length
9945 962	11,5 cm
9945 960	13,0 cm
9945 959	16,0 cm
9945 963	20,0 cm
Trade Pack 50 Pieces	

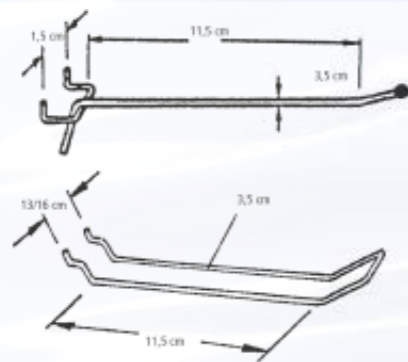

**Reel Holder f. Pegboard**

Code
9945 950



**Reel Fitting for 9945 950**

Code
9945 955







**kompletný cenník**  
**nájdete na**  
**www.SPORTS.sk**

kvalita, super ceny, najväčší sortiment

**Veľkoobchodný HYPERMARKET**  
 svetové značky na Slovensku ....všetko pod jednou strechou...

**www.SPORTS.sk**



veľkoobchod SPORTS spol. s r.o.  
 rybárske a športové potreby, živé nástrahy  
 www.SPORTS.sk; e-mail: info@sports.sk  
 Tel/Fax: 033 778 24 24