



RHINO

Rhino is definitely the brand for serious anglers. Particularly those who look for that extra performance in their products and an assurance of constant quality from their tackle. Extreme performance for a fair price.





RHINO

RODS

Rhino Reels R3
 Rhino DF Sea R4-9

ACCESSORIES

Rhino Steel Traces R10-11
 Rhino Trolling Spoons R12-19
 Rhino Trolling Accessories R20
 Rhino Rod Holder R21-25
 Rhino Kayak & Accessories R26-27
 Rhino VX Motor & Spare Parts R28-29
 Rhino Cobold & Spare Parts R30
 Rhino Motors Accessories R31
 Rhino Promotional Items R32

RHINO BLACK CAT R33-76

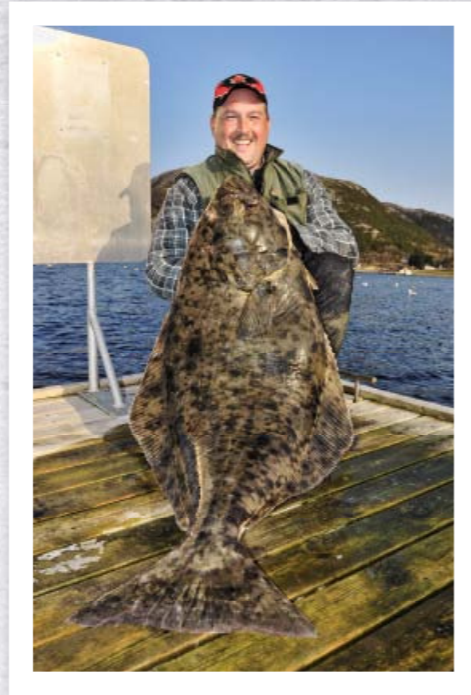

Strong brand – strong products!

Products in the Rhino Brand are characterised by their extreme strength and power. When the situation calls for ultra-strong equipment, Rhino products are the optimum choice. Whether it be rods, steel traces or even electric motors. Rhino products are famous for their perfect blend of robustness and top quality performance coupled with their extraordinary value for money. This has made them incredibly popular all over Europe and the UK.



REELS



360°-View
 On Our Website!
 360°
 www.zebco-europe.com

NOUVEAU
 N
 NEU · NEW

Multi-stack drag system
 with 5 carbon discs



RHINO PRESTIGE

Another unique gem to grace the Rhino product range. Indestructible reels have always been among our flagship products and the new Rhino Prestige reel continues this long tradition. The reel's design includes a distortion-free aluminium housing and numerous stainless steel components to complement the gearing, which has been optimised for power transfer. The Rhino Prestige is targeted at hard fighting fish like catfish and big pike, as well as for deep sea anglers and will immediately gain a deserved market reputation as an exceptional, strong and reliable "workhorse".

Code	Model	m/mm	Gear Ratio	Retrieve	Weight	Ball Bearings
0255 055	Prestige 755	120/0.40	4.86:1	85 cm	538 g	7
0255 065	Prestige 765	150/0.40	4.86:1	91 cm	541 g	7
0255 075	Prestige 775	280/0.40	4.86:1	104 cm	702 g	7

Spare Spool
0986 028 Alu
0986 029 Alu
0986 030 Alu

STANDARD TECHNICAL EQUIPMENT

- Two-speed oscillation system for perfect line distribution
- Super-hard, long-life drive gear in a brass-zinc alloy
- 7 high quality, shielded stainless steel ball bearings
- Extra-strong stainless steel main shaft
- Housing and rotor produced in aluminium to be completely distortion-free
- Continuous anti-reverse
- Ball-bearing duraluminium spool with anodized front edge and anti-slip spool core
- Multi-stack drag system with 5 carbon discs



BALTIC TROLLING RIGGER

Shorter downrigger rods take up less space, meaning easier storage and more room on the boat when a fight is on. Mike Luner (two-time European Trolling Championship runner-up) developed the new range, with a central focus on providing sufficient power – even for big salmon – balanced with enough softness to ensure the right amount of action.

Code	Length	Sections	C.W.	Tr.-Length	Weight
1457 210	2.10 m	2	10-20 lbs	1.13 m	340 g
1457 240	2.40 m	2	10-20 lbs	1.28 m	380 g

BALTIC TROLLING PLANER BOARD

Powerful yet sensitive rod for planer board angling. Whether you are fishing with inline boards or larger planer boards, this rod offers the necessary length to hold the line above the water and can take large paravanes or small diving discs without compromising its positive fight qualities.

Code	Length	Sections	C.W.	Tr.-Length	Weight
1458 260	2.60 m	2	10-20 lbs	1.35 m	418 g

BALTIC TROLLING DIVER

To satisfy widespread demand, a diver rod in the high-quality Rhino DF design. In contrast to the hugely successful Dive Master, the new Diver has more of a through action. Now the trolling angler has a choice of which action he prefers.

Code	Length	Sections	C.W.	Tr.-Length	Weight
1459 285	2.85 m	2	15-25 lbs	1.50 m	450 g

BALTIC TROLLING INLINE

An innovation for inline fans. These rods make line tangling around the rings a thing of the past. The rods' hallmark is their sensitive through action that leaves nothing to be desired when it comes to power. Also a good choice for light piking. Threader included.

Code	Length	Sections	C.W.	Tr.-Length	Weight
1456 210	2.10 m	2	10-20 lbs	1.13 m	280 g
1456 240	2.40 m	2	15-25 lbs	1.24 m	305 g

Christian Tolke (D)



All rods on this page:





RHINO TROLLING TEAM RIGGER WITCH

This special downrigger rod makes trolling a magical experience. With its trendy design to match the Dive Master this rod will soon find many friends. The tough blank will take all the strain that occurs when trolling.

Code	Length	Sections	C.W.	Tr-Length	Weight
1216 210	2.10 m	2	30-70 g/10-20 lbs	1.10 m	340 g
1216 240	2.40 m	2	30-70 g/10-20 lbs	1.30 m	380 g



RHINO TROLLING TEAM DIVE MASTER

Outstanding for pike and salmon trolling. When it comes to the crunch with divers the rod stands the test with the necessary stiff backbone. The sensitive tip will subdue even lightly hooked opponents during the fight. Perhaps the best rod ever to come to market for this area of angling. Also excellent for pirking with a multiplier reel.

Code	Length	Sections	C.W.	Tr-Length	Weight
1217 285	2.85 m	2	80-150 g/15-25 lbs	1.50 m	394 g



RHINO DF SEA TRAVEL XH

A fantastic spinning rod with short sections and powerful action (120 g casting weight) for sea fishing. Ideal for those travelling in search of bigger or hard fighting species - from Norway to Florida. The Sea Travel is the ideal "all-rounder" for fishing lures such as large lead-heads, soft rubbers, light to medium-sized pinks, wobblers and spoons.

Code	Length	Sections	C.W.	Tr-Length	Weight
1284 240	2.40 m	4	120 g	0.67 m	355 g



RHINO DF BOAT TRAVEL XH

More and more deep sea anglers are heading for far-flung destinations that can only be reached by plane. Our Boat Travel rods have short sections that can be packed in a suitcase – farewell to bulky and "lost in transit" rod tubes! The Boat Travel XH is a true all-rounder with a powerful but pleasantly mellow action.

Code	Length	Sections	Line class	Tr-Length	Weight
1285 210	2.10 m	4	20 lb	0.60 m	440 g



Sven Weide (D)



All rods on this page:





RHINO DF BIG FISH

Developed and engineered for heavy fish like big cod. The BIG FISH has all the advantages of a big fish rod. Its unbendable power and durability make it possible to tame really big fish.

Code	Length	Sections	C.W.	Tr-Length	Weight
1134 240	2.40m	2	300 g	1.25 m	430 g
1134 270	2.70m	2	300 g	1.40 m	470 g
1134 300	3.00m	2	300 g	1.55 m	495 g



RHINO DF JIG ZONE L

Lighter version of the Rhino DF Jig Zone H. With its slightly softer action almost tailor made for use with braided lines. Perfect when lighter pirk weights are enough.

Code	Length	Sections	C.W.	Tr-Length	Weight
1137 270	2.70 m	2	50-140 g	1.40 m	350 g

All rods on this page:



RHINO DF JIG ZONE H

The perfect rod for codling fishing with Pirks and Jigs. Made of the DF-Carbon Material and fitted with SIC-rings, the blank provides enough power even for deep water fishing.

Code	Length	Sections	C.W.	Tr-Length	Weight
1136 280	2.80 m	2	80-175 g	1.45 m	380 g



RHINO DF

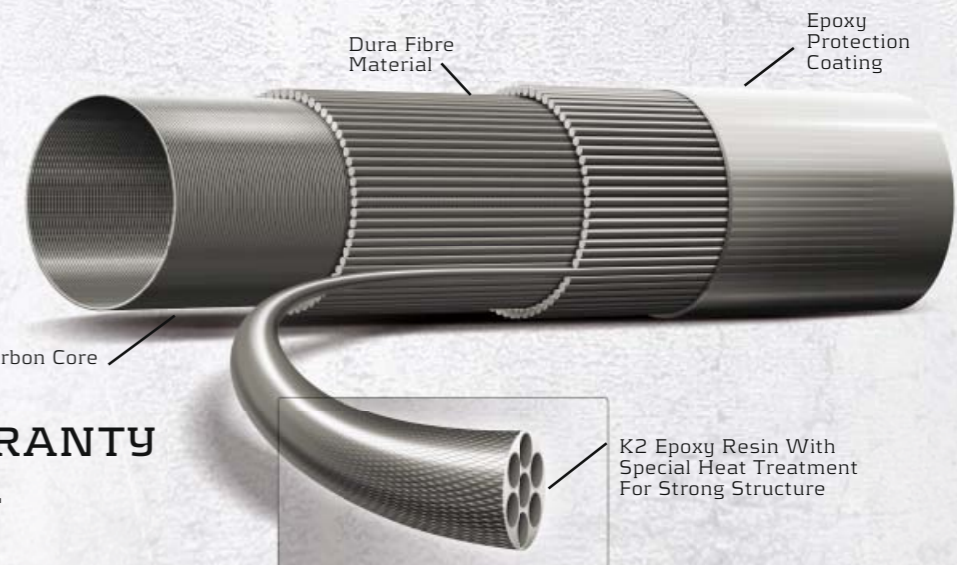

LIFETIME WARRANTY ON THE BLANK.



RHINO

STEEL TRACES



STEEL TRACES

Rhino products stand for uncompromising power and provide maximum reliability. The new Rhino Traces are available in various specifications with a choice of 7 or 49 filaments. The 7-filament version is ideal if you require extreme strength, whilst the 49-filament version is especially soft.



RHINO STEEL TRACES

Nylon-coated, with a barrel-type swivel and a safety swivel

Code	Description	Ø/mm	BS	Length
2305 006	Wire 1x7	0.24	6 kg	0.3 m
2305 009	Wire 1x7	0.27	9 kg	0.3 m
2305 013	Wire 1x7	0.33	13 kg	0.3 m
2306 006	Wire 1x7	0.24	6 kg	0.5 m
2306 009	Wire 1x7	0.27	9 kg	0.5 m
2306 013	Wire 1x7	0.33	13 kg	0.5 m
2306 017	Wire 1x7	0.39	17 kg	0.5 m

2307 009	Wire 1x7	0.27	9 kg	0.7 m
2307 013	Wire 1x7	0.33	13 kg	0.7 m
2307 017	Wire 1x7	0.39	17 kg	0.7 m

2 IN A PACK
IN PACKS OF 10



RHINO STEEL TRACES

Nylon-coated, with a loop at both ends

Code	Description	Ø/mm	BS	Length
2316 005	Wire 1x7	0.21	5 kg	0.7 m
2316 008	Wire 1x7	0.27	8 kg	0.7 m
2316 012	Wire 1x7	0.33	12 kg	0.7 m

2 IN A PACK
IN PACKS OF 10



RHINO STEEL TRACES

Nylon-coated, with a barrel swivel and safety swivel

Code	Description	Ø/mm	BS	Length
2317 009	Wire 1x7	0.27	9 kg	0.5 m
2317 012	Wire 1x7	0.33	12 kg	0.5 m
2317 015	Wire 1x7	0.36	15 kg	0.5 m

2 IN A PACK
IN PACKS OF 10



1x7



RHINO STEEL TRACES

Nylon-coated, with a barrel swivel and safety swivel

Code	Description	Ø/mm	BS	Length
2318 005	Wire 7x7	0.34	5 kg	0.5 m
2318 008	Wire 7x7	0.38	8 kg	0.5 m
2318 012	Wire 7x7	0.42	12 kg	0.5 m

2 IN A PACK
IN PACKS OF 10



RHINO STEEL TRACES

Nylon-coated, with a barrel-type swivel and a safety swivel

Code	Description	Ø/mm	BS	Length
2310 006	Wire 7x7	0.35	6 kg	0.3 m
2310 009	Wire 7x7	0.39	9 kg	0.3 m
2310 013	Wire 7x7	0.45	13 kg	0.3 m

2311 006	Wire 7x7	0.35	6 kg	0.5 m
2311 009	Wire 7x7	0.39	9 kg	0.5 m
2311 013	Wire 7x7	0.43	13 kg	0.5 m
2311 017	Wire 7x7	0.45	17 kg	0.5 m

2312 006	Wire 7x7	0.35	6 kg	0.7 m
2312 009	Wire 7x7	0.39	9 kg	0.7 m
2312 013	Wire 7x7	0.43	13 kg	0.7 m
2312 017	Wire 7x7	0.45	17 kg	0.7 m

2 IN A PACK
IN PACKS OF 10



7x7



RHINO STEEL TRACES

Wire 1x7, Nylon-coated, with a loop and treble hook

Code	Hook Size	Ø/mm	BS	Length
4201 005	8	0.21	5 kg	0.6 m
4201 008	6	0.27	8 kg	0.6 m
4201 012	5	0.33	12 kg	0.6 m
4201 015	1	0.36	15 kg	0.6 m

1 IN A PACK
IN PACKS OF 10



RHINO STEEL TRACES

Wire 1x7, Nylon-coated, with a loop and double hook

Code	Hook Size	Ø/mm	BS	Length
4202 003	9	0.18	3 kg	0.6 m
4202 005	7	0.21	5 kg	0.6 m
4202 007	5	0.24	7 kg	0.6 m
4202 009	2	0.27	9 kg	0.6 m

1 IN A PACK
IN PACKS OF 10



RHINO STEEL TRACES

Wire 1x7, Nylon-coated, with a loop and single hook

Code	Hook Size	Ø/mm	BS	Length
4203 008	2	0.27	8 kg	0.6 m
4203 012	1/0	0.33	12 kg	0.6 m
4203 015	2/0	0.36	15 kg	0.6 m

1 IN A PACK
IN PACKS OF 10



RHINO STEEL TRACES

Wire 7x7, Nylon-coated, with a loop and treble hook

Code	Hook Size	Ø/mm	BS	Length
4204 005	8	0.34	5 kg	0.6 m
4204 008	6	0.38	8 kg	0.6 m
4204 012	5	0.42	12 kg	0.6 m
4204 015	1	0.45	15 kg	0.6 m

1 IN A PACK
IN PACKS OF 10



RHINO STEEL TRACES

Wire 7x7, Nylon-coated, with a loop and single hook

Code	Hook Size	Ø/mm	BS	Length
4205 008	2	0.38	8 kg	0.6 m
4205 012	1/0	0.42	12 kg	0.6 m
4205 015	2/0	0.45	15 kg	0.6 m

1 IN A PACK
IN PACKS OF 10



Holger Aderkass (D)



RHINO TROLLING SPOONS

You want to catch big fish, right? And you want to troll medium and large lures with the same speed? This is where Rhino Trolling Spoons really come into their own category. The lures have been specially designed by our trolling experts for trolling in the Baltic Sea. In open water and during the herring run, salmon and sea trout often prefer larger baits. We have put together an optimum range of colours for you whether you are fishing off Rügen, Fehmarn, Bornholm, Simrishamn or the Gulf of Finland – you will always be well prepared. The agile, almost aggressive swim action also attracts predators to take the bait at a trolling speed to match that used by most boats.

MAG	Length	Colour	Xtra MAG	Length	Colour
3395 001	115 mm	Black Shiner	3395 101	150 mm	Black Shiner
3395 002	115 mm	Black Devil	3395 102	150 mm	Black Devil
3395 003	115 mm	Master Herring	3395 103	150 mm	Master Herring
3395 004	115 mm	Beluga	3395 104	150 mm	Beluga
3395 005	115 mm	Copper Blue Dolphin	3395 105	150 mm	Copper Blue Dolphin
3395 006	115 mm	Gold Green Dolphin	3395 106	150 mm	Gold Green Dolphin
3395 007	115 mm	Sunny Honey	3395 107	150 mm	Sunny Honey
3395 008	115 mm	Rainbow Trout	3395 108	150 mm	Rainbow Trout
3395 009	115 mm	Swedish Flag	3395 109	150 mm	Swedish Flag
3395 010	115 mm	King Salmon	3395 110	150 mm	King Salmon
3395 011	115 mm	Triple G	3395 111	150 mm	Triple G
3395 012	115 mm	Fog Killer	3395 112	150 mm	Fog Killer
3395 014	115 mm	Bloody Tail	3395 114	150 mm	Bloody Tail
3395 015	115 mm	Watermelon	3395 115	150 mm	Watermelon
3395 016	115 mm	Crystal Frog	3395 116	150 mm	Crystal Frog
3395 017	115 mm	Black Gold Angel	3395 117	150 mm	Black Gold Angel
3395 019	115 mm	Pink Sunshine	3395 119	150 mm	Pink Sunshine

1 IN A PACK
IN PACKS OF 5

1 IN A PACK
IN PACKS OF 5



Black Shiner



Sunny Honey

For three years in succession, the largest salmon in the Finnish Championship in Helsinki fell to these colours. Coincidence? Hardly. An outstanding lure in murky waters and light algae. Highly successful in the top 15 metres.



Black Devil

Black Shiner resp. Black Devil
A natural colour pattern in black/glow or with a holographic film guarantees large catches in all conditions. If you are going deep, we recommend combining with the Glow colour (No. 1).



Rainbow Trout

A rainbow in the evening always brings fish! Yet even in poor weather and on a downrigger, you should always have these colours in the water.

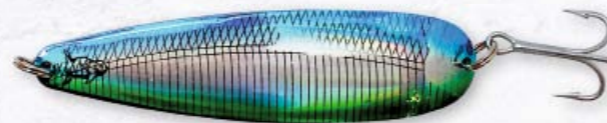

Master Herring

Green & silver and blue & silver – both classics in clear water. When combined on a spoon they are a perfect match, whether sunny or overcast.

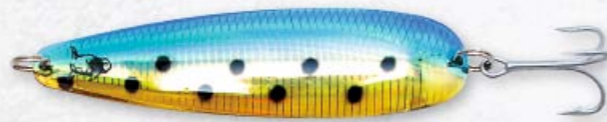

Swedish Flag

Salmon and sea trout know no borders. So it is little surprise that many trolling anglers love these colours. A favourite in the sun and when there are slight white crests on the water.



Beluga

Neon green & yellow and white – these colours should be banned! They never fail to catch whether with a down rigger or flat, in sunshine or adverse weather.



Backside: Copper



King Salmon

Blue silver with magenta stripes – a real ray of sunshine. With copper inner side – the secret to success of many trolling guides in recent years. Most successful in the top 15 metres.



Copper Blue Dolphin

Copper spoons – the secret to success of many of our professionals in sunny weather. The combination with metallic blue and neon yellow makes this lure highly successful in the top 10 metres.



Backside: Copper

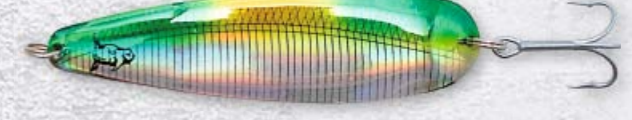

Triple G

Subtle green & yellow on holographic film. Many large roaming salmon, meet their fate with this spoon. At its most lethal just beneath the surface, in the sun or overcast conditions.



Gold Green Dolphin

Green and neon yellow on gold is often the winner on heavily fished estuaries. The somewhat more discreet colours catch in the top 15 metres in sunny weather.



Backside: Gold

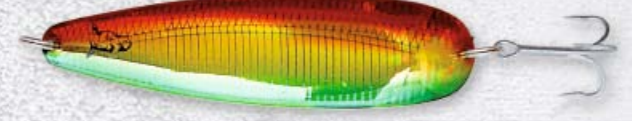

Fog Killer

As the name suggests, this lure is most suited to adverse weather, mornings and evenings the most productive.



Bloody Tail

This red-tailed lure has already given many a fish a bloody nose. With its fluorescent colours the lure is a hit on the surface in overcast weather or on a downrigger whatever the light conditions. The mother-of-pearl lacquer on the inner side provides additional attraction.



Backside: Pearl White



Watermelon

With black spots, red pulp and green sides – even if salmonids are no vegetarians, these colours have proven successful. These retro colours have been popular for decades in sunny conditions and near the surface. Rhino is bringing them back to the market with a modern flash design and highly vivid colours to amplify the contrast!

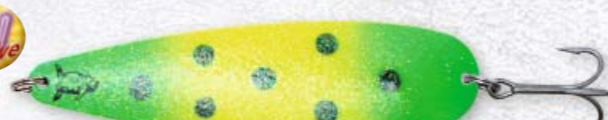

Crystal Frog

Froggy – a lure that no trolling tackle box should be without! The high-quality crystal lacquer enhances the attraction of this colour pattern, producing vastly increased success rates. The lure can be fished successfully at all depths and in all weather conditions. Also try it with white inner foil when fishing way down deep on a downrigger!



Backside: Real Gold

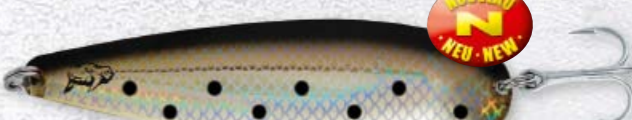

Black Gold Angel

Natural colours on a golden spoon are often advantageous in clear water. Particularly recommended in sunny conditions.



Pink Sunshine

Bright colours often tempt bites from large spawning salmon. The UV-active yellow means the lure is equally effective on the surface or on a downrigger.



Mike Luner (D)



RHINO

SALMON SPECIAL SERIES

In recent years, the waters off the German island of Rügen have become a popular location for trolling. While the latest trends in lures and tackle used to be dictated by Scandinavia or our cousins across the Atlantic, today Germany is a hub of innovation. All areas of angling have their own special requirements. With the Special Series, we wanted to rise to that challenge! With the addition of new products, and by refining the colour patterns of the existing range, we have given the already fantastically successful Rhino lures a new dimension. Hundreds of landed salmon and sea trout as well as precise knowledge of the behaviour of foraging fish have inspired the colour concept of this special range.

MAG	Length	Model
3395 031	115 mm	Rügen
3395 032	115 mm	Copper Master Herring
3395 033	115 mm	Taff Inaff
3395 034	115 mm	Gold Swedish Flag
3395 035	115 mm	Svenstrup special
3395 036	115 mm	Glow Blue Shiner
3395 037	115 mm	Natural Copper Blue Dolphin
3395 038	115 mm	Natural Gold Green Dolphin

1 IN A PACK
IN PACKS OF 5



Rügen

Green-yellow-green is always a deadly combination. In sunny weather and where there is a build-up of algae, these colours deliver the goods. With its fluorescent colours the lure has an excellent success rate from the surface down to 60 feet on a downrigger. As with the Bloody Tail, the red stripe results in extra fish on the bank.

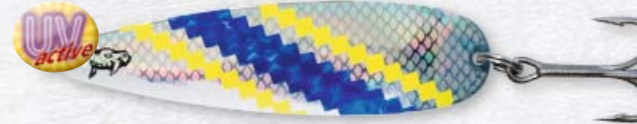

Taff Inaff

The lure used by German trolling expert Frerk Petersen to land many a monster salmon. Works brilliantly on a downrigger at 50 to 60 feet when the sun is shining but always worth a try on the surface too.



Svenstrup Spezial

When Danish trolling guru Jan Svenstrup allows Rhino to use his favourite colours, we do not need a second invitation! In recent years, the island of Moen has become popular among Danish anglers, who fish off the German island of Rügen with great success. And this colour has often been the killer.

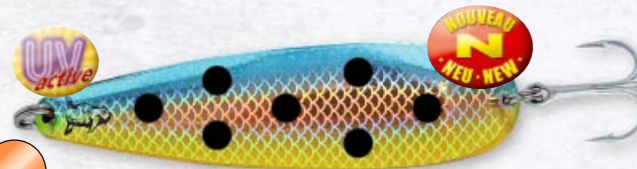

Natural Copper Blue Dolphin

Improved aesthetics thanks to the copper blank. The combination with metallic blue and neon yellow makes this lure highly successful when the sun is shining and in the top 10 metres of the water.



Backside: Real Copper

RHINO TROLLING INSIDE FOILS

The intelligent solution to tuning your trolling lures. Often it is the inner side that decides whether a lure is taken – ultimately, it is this that reflects the light. As most lures are supplied with a silver inner side, we have provided gold, copper and white to vary your options. Available in two sizes, suitable for Rhino Trolling Spoons in large Mag and Xtra Mag sizes. Highly adhesive and scratchproof.

TROUT KILLER	Length	Colour
3397 997	87 mm	mirror gold
3397 998	87 mm	mirror copper
3397 999	87 mm	white

3 IN A PACK
IN PACKS OF 10



mirror gold



mirror copper



white



Jan Svenstrup (DK)

TROUT KILLER SPOON

At last, we can offer the alluring Rhino spoon in a size specially designed for sea trout, which prefer a smaller lure fished close to the shore. In the new Trout Killer Spoon range, we are offering a tailor-made spoon and colour concept specially designed for sea trout sport. The retrieve action of the spoons ranges from agile to aggressive while the speed has been optimally matched to the other spoons in the Rhino range. Don't forget to try this lure for salmon at depth when small sprats are on the menu for the fish! Many a 10-kg salmon has already given in to the temptation.

Code	Length	Colour
3397 002	87 mm	Black Devil
3397 004	87 mm	Beluga
3397 005	87 mm	Copper Blue Dolphin
3397 006	87 mm	Gold Green Dolphin
3397 007	87 mm	Sunny Honey
3397 008	87 mm	Rainbow Trout
3397 010	87 mm	King Salmon
3397 013	87 mm	Lemon Ice
3397 014	87 mm	Bloody Tail
3397 015	87 mm	Watermelon

1 IN A PACK
IN PACKS OF 5

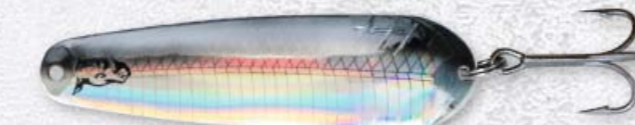

Black Devil

A natural colour pattern in black with a holographic film guarantees large catches in all conditions.



Copper Blue Dolphin

Copper spoons – the secret to success of many of our professionals in sunny weather. The combination with metallic blue and neon yellow makes this lure highly successful in the top 10 metres.



Sunny Honey

For three years in succession, the largest salmon in the Finnish Championship in Helsinki fell to these colours. Coincidence? Hardly. An outstanding lure in murky waters and light algae. Highly successful in the top 15 metres.



King Salmon

Blue silver with magenta stripes – a real ray of sunshine. With copper inner side – the secret to success of many trolling guides in recent years. Most successful in the top 15 metres.



Bloody Tail

This red-tailed lure has already given many a fish a bloody nose. With its fluorescent colours the lure is a hit on the surface in overcast weather or on a downrigger whatever the light conditions. The mother-of-pearl lacquer on the inner side provides additional attraction.

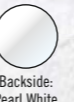

Backside: Pearl White



Christian Tolke (D)



Beluga

Neon green & yellow and white – these colours should be banned! They never fail to catch whether with a down rigger or flat, in sunshine or adverse weather.

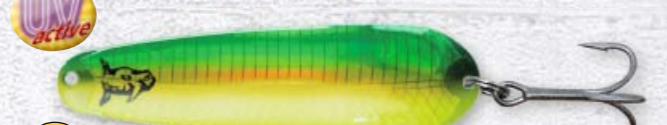

Gold Green Dolphin

Green and neon yellow on gold is often the winner on heavily fished estuaries. The somewhat more discreet colours catch in the top 15 metres in sunny weather.



Rainbow Trout

A rainbow in the evening always brings fish! Yet even in poor weather and on a downrigger, you should always have these colours in the water.



Lemon Ice

Eye-catchers for fish! Neon orange and neon yellow on white – a natural stop sign for salmonids. Remarkably successful on a downrigger, in poor weather and in the autumn when fish are heading for the rivers. The mother-of-pearl lacquer on the inner side provides additional attraction.



Backside: Pearl White



Watermelon

With black spots, red pulp and green sides – even if salmonids are no vegetarians, these colours have proven successful. These retro colours have been popular for decades in sunny conditions and near the surface. Rhino is bringing them back to the market with a modern flash design and highly vivid colours to amplify the contrast!



RHINO LAX SPOON (L / XL)

A tried and trusted design. It is difficult to go wrong with this trolling spoon in terms of retrieval speed. With a slow retrieve, it wobbles alluringly, and with a faster retrieve the spoon kicks quickly without rotating. We are sure many a trolling fan will be adding this design to his lure box alongside previous Rhino spoons.



Peter Bähr (D)

Lax Spoon XL	Length	Model
3398 101	150 mm	Black Shiner
3398 102	150 mm	Black Devil
3398 104	150 mm	Beluga
3398 106	150 mm	Gold Green Dolphin
3398 108	150 mm	Rainbow Trout
3398 110	150 mm	King Salmon
3398 111	150 mm	Tripple G
3398 112	150 mm	Fog Killer
3398 114	150 mm	Bloody Tail
3398 115	150 mm	Watermelon
3398 132	150 mm	Copper Master Herring
3398 134	150 mm	Gold Swedish Flag
3398 119	150 mm	Pink Sunshine
3398 137	150 mm	Natural Copper Blue Dolphin
3398 138	150 mm	Natural Gold Green Dolphin

1 IN A PACK
IN PACKS OF 5

Lax Spoon L	Length	Model
3398 001	115 mm	Black Shiner
3398 002	115 mm	Black Devil
3398 004	115 mm	Beluga
3398 006	115 mm	Gold Green Dolphin
3398 008	115 mm	Rainbow Trout
3398 010	115 mm	King Salmon
3398 011	115 mm	Tripple G
3398 012	115 mm	Fog Killer
3398 014	115 mm	Bloody Tail
3398 015	115 mm	Watermelon
3398 032	115 mm	Copper Master Herring
3398 034	115 mm	Gold Swedish Flag
3398 019	115 mm	Pink Sunshine
3398 037	115 mm	Natural Copper Blue Dolphin
3398 038	115 mm	Natural Gold Green Dolphin

1 IN A PACK
IN PACKS OF 5

GLOW
in the
dark



Black Shiner



Black Devil

Black Shiner resp. Black Devil
A natural colour pattern in black/glow or with a holographic film guarantees large catches in all conditions. If you are going deep, we recommend combining with the Glow colour (No. 1).



Beluga

Neon green & yellow and white – these colours should be banned! They never fail to catch whether with a down rigger or flat, in sunshine or adverse weather.



Gold Green Dolphin

Green and neon yellow on gold is often the winner on heavily fished estuaries. The somewhat more discreet colours catch in the top 15 metres in sunny weather.



Rainbow Trout

A rainbow in the evening always brings fish! Yet even in poor weather and on a downrigger, you should always have these colours in the water.



King Salmon

Blue silver with magenta stripes – a real ray of sunshine. With copper inner side – the secret to success of many trolling guides in recent years. Most successful in the top 15 metres.



Triple G

Subtle green & yellow on holographic film. Many large roaming salmon, meet their fair with this spoon. At its most lethal just beneath the surface, in the sun or overcast conditions.



Fog Killer

As the name suggests, this lure is most suited to adverse weather, mornings and evenings the most productive.

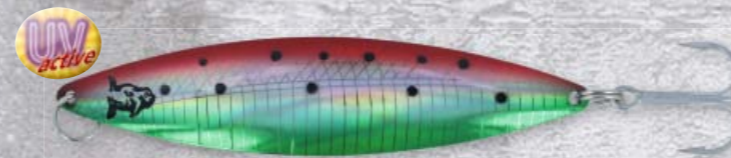

Watermelon

With black spots, red pulp and green sides – even if salmonids are no vegetarians, these colours have proven successful. These retro colours have been popular for decades in sunny conditions and near the surface. Rhino is bringing them back to the market with a modern flash design and highly vivid colours to amplify the contrast!



Bloody Tail

This red-tailed lure has already given many a fish a bloody nose. With its fluorescent colours the lure is a hit on the surface in overcast weather or on a downrigger whatever the light conditions. The mother-of-pearl lacquer on the inner side provides additional attraction.

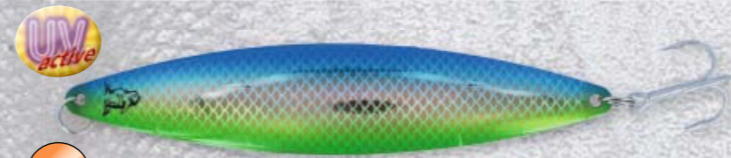

Copper Master Herring

A subtle blue-green pattern on a copper spoon. Fish are always tempted to take a closer look when the sun is shining and in clear water. Too many silver reflections can actually scare them off. This is where the copper spoon comes into its own – often less is more!



Gold Swedish Flag

Similar concept to the Copper Master Herring. Gold is not only more precious than silver, it can also mean considerably more fish in the boat in clear waters. The black spots provide necessary contrast and an additional attraction for the fish.

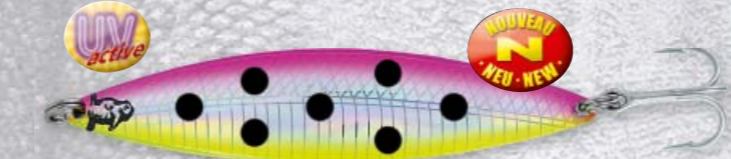

Pink Sunshine

Bright colours often tempt bites from large spawning salmon. The UV-active yellow means the lure is equally effective on the surface or on a downrigger.



Natural Copper Blue Dolphin

Improved aesthetics thanks to the copper blank. The combination with metallic blue and neon yellow makes this lure highly successful when the sun is shining and in the top 10 metres of the water.

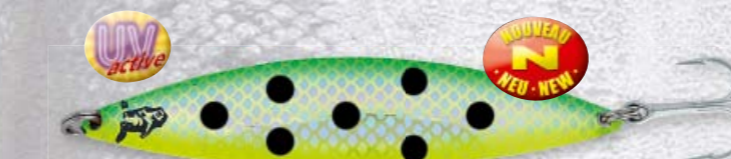

Natural Gold Green Dolphin

Improved aesthetics thanks to the golden spoon. Exceptional in sunny weather at the surface and down to 15 metres on a downrigger.



Lars Vormelker (D)



SOFTFISH LURE

At last, an attractive rubber bait to fish behind flashers and dodgers. The transparent matrix enables highly attractive colour effects, which we offer in the tried and trusted Rhino Trolling Spoon designs.

Code	Length	Weight	Model
3375 001	10.5 cm	12 g	Black Shiner
3375 002	10.5 cm	12 g	Ambulance
3375 003	10.5 cm	12 g	Gold Swedish flag
3375 004	10.5 cm	12 g	King Salmon
3375 005	10.5 cm	12 g	Black Glitter

3 IN A PACK
IN PACKS OF 5



Ambulance



Black Shiner



Gold Swedish Flag



King Salmon



Black Glitter

FLASHER WITH SOFTFISH LURE

A long held secret of the professionals – flashers and lures in a similar colour! We have followed this approach closely with our compact flasher range. Ready-rigged with 0.60 mm monofilament and VMC permasteel hooks. Set contains a spare softlure fish in case the original is bitten off after a few successful trips.

Code	Length	Hook	Ø	Model
3376 001	70 cm	1/0	0.60 mm	Black Shiner hook
3376 002	70 cm	1/0	0.60 mm	Gold Swedish flag
3376 003	70 cm	1/0	0.60 mm	King Salmon hook

1 IN A PACK
IN PACKS OF 5

Black Shiner
Provides a high contrast when fishing in the depths. Extremely successful for many years, this colour combination is now available in a flasher combi.



Gold Swedish Flag

This colour is particularly successful in the top 30-60 feet of water. Thanks to the UV-active colours, the flasher excels both when the sun is shining and when the waters are murky.



King Salmon

King Salmon: This combination has also been conceived for shallower flasher use. Sunshine and clear waters yield the best results with this colour.



RHINO BAIT HOLDER



We have added a natural bait system into the Rhino Bait Holder range that immediately convinced us in practical testing on the Baltic Sea: The range comprises natural bait heads in two sizes and ten colours: The new heads were developed by Mika Kampmann and are based upon real fish. It is the combination of accuracy and alluring bait action that makes this system so exceptional.

No effort is required when it comes to set-up in almost all cases. The large head has been tailor made for herring and the smaller model for roach and similar species. Using both heads allows a broad range of various deadbaits (10 - 28cm) to be brought to bear. When it came to selecting colours, we called upon both the tried and trusted Rhino colours as well as recommendations from experience with natural bait systems.

Ideal bait sizes:

Rhino Bait Holder Medium: e.g. Roach from 10-13 cm

Rhino Bait Holder Large: e.g. Herring from 18-23 cm

Code	Size	Model
4285 001	Medium	Mika
4285 002	Medium	Black Shiner
4285 003	Medium	Black Devil
4285 004	Medium	Master Hering
4285 005	Medium	Gold Green Dolphin
4285 006	Medium	UV Watermelon
4285 007	Medium	Gold Swedish Flag
4285 008	Medium	Blue Ice
4285 009	Medium	King Salmon
4285 010	Medium	Last Try

3 IN A PACK
IN PACKS OF 5

Code	Size	Model
4285 101	Large	Mika
4285 102	Large	Black Shiner
4285 103	Large	Black Devil
4285 104	Large	Master Hering
4285 105	Large	Gold Green Dolphin
4285 106	Large	UV Watermelon
4285 107	Large	Gold Swedish Flag
4285 108	Large	Blue Ice
4285 109	Large	King Salmon
4285 110	Large	Last Try

3 IN A PACK
IN PACKS OF 5



Mika



Black Shiner



Black Devil



Master Hering



Gold Green Dolphin



UV Watermelon



Gold Swedish Flag

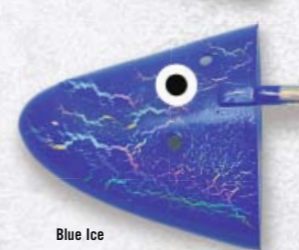

Blue Ice



King Salmon



Last Try



Mika Kampmann (D)

Perfect Fit



Bait Holder assembled;
delivered unassembled
without hook and swivel

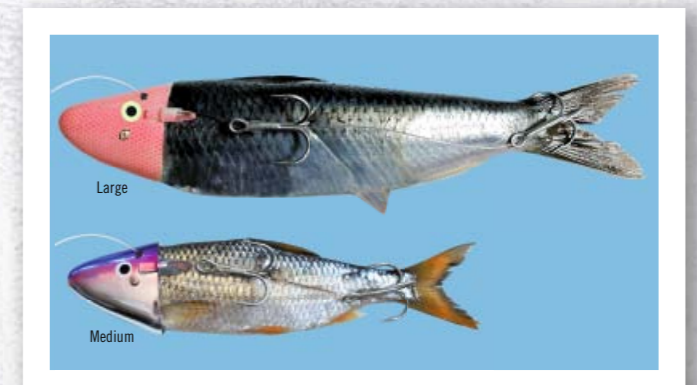

Large

Medium



TROLLING TEAM LINE

Tight clips and the everyday stresses of trolling place enormous strain on a line. High durability, coupled with a high breaking strain, is a vital ingredient in the selection of a line for trolling. The Trolling Team Line meets these criteria and comes in a discrete colour as preferred by many trolling anglers.

Code	Ø	BS	Length
2341 040	0.40 mm	26 lbs/11.8 kg	333 m
2341 045	0.45 mm	34 lbs/15.4 kg	333 m
2341 140	0.40 mm	26 lbs/11.8 kg	3333 m
2341 145	0.45 mm	34 lbs /15.4 kg	3333 m

333M: IN PACKS OF 5



RHINO PARAVANE

Head weights deliver the bait to the desired depth, enabling effective angling at a variety of water depths. Customary paravanes, however, have a distinct disadvantage. They require a leader and the leader is dependent on the length of the rod, to enable you to still land the fish. Not so with the Rhino Paravan. This clip-on weight can attach anywhere to the line without causing damage. It neither affects the agile behaviour of the bait, nor alarms the fish because seaweed has become tangled up with it etc. All of this means less time with the rod in your hand than without the Rhino Paravan.

Weight	bright orange	matt grey	P/Package
10 g	6037 001	6037 101	2
25 g	6037 002	6037 102	2
45 g	6037 003	6037 103	2
70 g	6037 004	6037 104	1
95 g	6037 005	6037 105	1

IN PACKS OF 5



PRO STOW BOX

A revival of the hugely successful lure box, specially designed for trolling anglers: much demanded, designed in collaboration with Mike Luner and capable of accommodating all types of lure – whether spoons, wobblers or pirkers – in separate compartments. The box combines a range of benefits:

- Numerous lures (up to 20 cm long) can be transported together.
- Clearly arranged storage.
- Prevents lures from tangling
- Lures are not thrown together, even if the box is tipped over.
- Lures are no longer left in wet compartments; the water drips down below. The box dries out when the lid is left open and the inserts can be removed where required

Code	Model	Size
8024 001	Pro Stow Box	21 cm x 24 cm x 42 cm

IN PACKS OF 5

RHINO BOAT ROD HOLDER

Range of high quality boat rod holders both for permanent attachment and flexible use on rented holiday boats.

RHINO XTRA ROD HOLDER

Made from robust plastic and designed to produce the lowest of production tolerances. Can be attached to the deck and has 12 rest positions with 360° rotation. Thanks to a built-in notch, the rod can only be set in one position and cannot shift into the other positions unwanted through shaking. The tilt mechanism is securely attached via fixed snap-in points and a robust adjuster bolt. The rod can be secured against jumping out via a rubber clamp. Weight: 400 g.

Code	Model
8207 001	Rhino Xtra Rod Holder



Mike Luner (D)

RHINO XTRA TUBE ROD HOLDER

Deck holder as with the Standard Xtra Rod Holder 8207 001, but with a fitted tube rod holder in polished aluminium. Rods can be taken out at great speed. The upper tube edge is designed to protect the rod handle with a soft plastic sleeve. With anti-twist device for rods with cross slots. The tilt mechanism is securely attached via fixed snap-in points and a robust adjuster bolt. Height: 30 cm. Weight: 530 g.

Code	Model
8207 002	Rhino Xtra Tube Rod Holder



RAIL MOUNT

Made from highly robust plastic. Complement to the deck holder when it needs to be mounted on a railing. Includes 4 bolts with self-locking nuts in stainless steel. Weight: 70 g.

Code Model
8207 992 Rail Mount



DECK HOLDER

Made from highly robust plastic with the lowest of production tolerances, with 12 rest positions and 360° rotation. Can be installed from above or sideways since the actual rod holder can receive the rod in one of two ways. Weight: 140 g.

Code Model
8207 990 Deck holder



CLAMP MOUNT

For mobile use of the standard rod holders 8207 001 or tube rod holder 8207 002. Clamp in metal with strong pressure screw. For boat sides up to 70 mm thick. Attached is the receiver for the rod holder in robust plastic with 12 rest positions and 360° rotation. Weight: 530 g.

Code Model
8207 993 Clamp Mount



FLUSH MOUNT

Made from highly robust plastic. For recessed installation in decks, trolling bars and side walls with 12 rest positions and 360° rotation. Weight: 80 g.

Code Model
8207 991 Flush Mount



RHINO XTRA ROD RACK

Three rod holder in shock resistant white plastic. Mounted with 6 stainless steel bolts (supplied). The bracket has additional storage capacity, e.g. for forceps and fishing knives. Dimensions: 45 x 30 cm. Weight: 830 g.

Code Model
8209 001 Rhino Xtra Rod Rack, for three rods

RHINO ALU TURN & TILT ROD HOLDER – FOR DECK MOUNTING

Tube rod holder in polished aluminium. Rods can be taken out at great speed. The upper tube edge is designed to protect the rod handle with a soft plastic sleeve. With anti-twist device for rods with cross slots. The tilt mechanism is adjusted via a push button through 90°-60°-30°-0°. 360° rotation is also guaranteed via a highly practical mechanism. Pull the rod holder upwards against spring pressure, twist accordingly and automatically re-engage. For deck mounting using four bolts (not supplied). Height: 30 cm. Weight: 870 g.

Code Model
8208 001 for deck mounting



RHINO ALU TUBE ROD HOLDER, FOR HORIZONTAL RAILING BARS

Fixed tube rod holder in polished aluminium. Rods can be taken out at great speed. The upper tube edge is designed to protect the rod handle with a soft plastic sleeve. With anti-twist device for rods with cross slots. For horizontal railing mounting via a super robust railing adapter (4 bolts, supplied). Suitable for 25 mm / 1" railing bars. Height: 30 cm. Weight: 740 g.

Code Model
8208 003 for horizontal railing bars



RHINO ALU TUBE ROD HOLDER, FOR VERTICAL RAILING BARS

Like 8208 003, only for vertical railing mounting via a super robust railing adapter (4 bolts, supplied). Suitable for 25 mm / 1" railing bars. Height: 30 cm. Weight: 680 g.

Code Model
8208 004 for vertical railing bars



RHINO ALU TURN & TILT ROD HOLDER – FOR RAILING MOUNTING

Like 8208 001, only for rail mounting via a super robust railing adapter (4 bolts, supplied). Suitable for 25 mm / 1" railing bars. Height: 30 cm. Weight: 1,080 g.

Code Model
8208 002 for railing mounting



DOWNRIGGER ADAPTER

Flexibility, stability and ease of use were top of the agenda when we developed the Rhino rod holder. Now you can also enjoy the comfort you have become accustomed to with a downrigger (Scotty Pro Pack). This special Downrigger Adapter allows you to choose the angle of your taut downrigger rod. When travelling or during a fight, the rod holder can be set vertically so it does not interfere during landing or netting maneuvers.

Code Model
8208 998 Downrigger Adapter



REDUCING PIECE

Is your railing only 22 mm / 7/8" thick? No problem. With this plastic half-shell, our alu tube rod holders can now be firmly affixed.

Code Model
8208 999 Reducing piece



RHINO DRY SUIT

Dry suit for extreme conditions. Indispensable for Kayak users in the cold season and a type of survival insurance. Boat anglers should also not be without this survival aid. The 100% waterproof, yet breathable, multi-function membrane ensures that the angler's body remains dry as well as free from sweat. This means that fewer thermal underclothes are required than you might think. With a large diagonal waterproof zip for putting on and removing, as well as elasticated cuffs and neck. Attached sock liners fit inside your preferred footwear.

Code	Model	Size
8967 001	Rhino Dry Suit	L
8967 002	Rhino Dry Suit	XL
8967 003	Rhino Dry Suit	XXL

100% nylon, breathable. Sock liner and collar: neoprene.



RECESSED HOLDER

Made from heavy-duty industrial quality plastic. Fits quickly and cleanly with adhesive into pre-made slots in the Rhino Sharkoon Kayak to enable the use of the Rhino Rod Holder 8207 001/002 (R 22) or Double Rod Holder Fitting (item no. 8207 003), etc.

Code	Model
8207 994	Recessed Holder



DISPLAY HOLDER

Holder that fits our multi-function bases and allows a fishfinder display, for example, to be screwed onto it.

Code	Model
8207 006	Display Holder

DOUBLE ROD HOLDER FITTING

This robust cross-bar can accommodate two Rhino Rod Holders simultaneously. This enables trolling from the kayak with two rods at the same time. The high quality materials and simple slot connections optimise flexibility on the water – allowing you to get to the fish more quickly and without stress.

Code	Model
8207 003	Double Rod Holder Fitting



MULTI STORE BAR

Three-rod tube rod holder for deck mounting with foot, also with storage capacity for knives, forceps etc., making it a versatile accessory.

Code	Model
8207 009	Multi store bar



ADJUSTABLE EXTENSION

Adjustable extension for rod holders and equipment mountings.

Code	Model
8207 008	adjustable extension

4 AND 3-ROD HOLDER MOUNTING

The 3-rod or 4-rod holder mountings provide space for several rod holders on the boat or kayak (mounted via deck holder 8207 900, see R 22). Also ideal for mounting equipment such as fishfinders or swing bars.

Code	Model
8207 004	4-Rod Holder Mounting
8207 007	3-Rod Holder Mounting



FISHFINDER MOUNTING INCL. SWINGER BAR

Stable and functional mounting for fishfinders. With user-friendly fittings and swivelling cross-bar. Now you can have your fishfinder display permanently in sight and see exactly where the big specimens are hiding up.

Code	Model
8207 005	Fishfinder Mounting incl. Swinger Bar





RHINO SHARKOON KAYAK

Enjoy the total freedom and unique fishing experiences offered by the Rhino Sharkoon Kayak. With its low weight and high-quality fittings, the kayak is easy to transport and launch wherever you want to fish. The dynamic hull design guarantees fast, stable and safe progress with minimal effort. The front area of the kayak houses a water-tight storage area – ideal for storing delicate equipment. Two additional storage compartments keep your belongings safe and secure using rubber nets. Comes complete with side paddle mountings and a comfortable standard seating mat. A range of accessories are available for the Rhino Sharkoon Kayak which allow you to transform the basic kayak into a customized catching machine exactly tailored to your requirements.

Code	Model	Size L x W x H	Weight
9928 300	Sharkoon Kayak	300 x 78 x 33 cm	21.5 kg



KAYAK TROLLEY

This high-quality trolley is the ideal aid for transporting your kayak. Simply place the kayak on the trolley, fasten the strap, tighten and away you go! The robust wheels with maximum-grip treads can cope with any terrain enabling fast progress wherever you may be.

Code	Model
8705 005	Kayak Trolley



420 D Nylon

KAYAK SEAT

This comfortable Kayak Seat finished in high-quality nylon ensures secure and comfortable seating whether for short or long periods. The ergonomic design of the seat provides excellent support to for the paddler's back, enabling hours of fatigue-free paddling.

Code	Model
9980 015	Kayak Seat



Picture shows Sharkoon Kayak fitted with optional accessories.

ALUMINIUM PADDLES

Robust yet light paddles that sit comfortably and securely in the hand. Available either in rigid, one-piece design or with adjustable paddle blade angles. Anglers who value reliable equipment at a fair price will appreciate these paddles. The adjustable version can be taken apart for transport purposes.

Code	Model	Length	Weight
9929 001	Alu Paddle	2.20 m	1450 g
9929 003	Alu Paddle, adjustable	2.40 m	1100 g



STABILISER

Lateral stabiliser for kayak fishing. Experience shows that fitting a stabiliser on one side of the kayak significantly improves the use of a kayak for fishing. Mounted on the kayak via our multi-function adapter foot.

Code	Model
9980 016	Stabiliser





RHINO

VX

RHINO VX

ELECTRIC OUTBOARD MOTOR

Always keeping you moving...

RHINO VX ELECTRIC OUTBOARD MOTOR

Strong, stronger, Rhino VX! Introducing one of the most powerful electric outboard motors on the market. The Rhino VX is outstanding in its low power consumption, allowing it to be used for longer periods with regular battery capacity. The motor is operated and steered with a telescopic tiller (except Rhino VX 28) offering 5 forward and 2 reverse speeds. The motor can be tilted up by pushing a button and the depth of the prop as well as steering counterforce are continuously adjustable. With battery indication (except Rhino VX 28) to prevent any loss of power scenarios. The Rhino VX features exceptionally simple, comfortable and safe overall handling. This electric outboard motor has become a reliable companion to thousands of boat anglers.

Code	Model	Speeds	Max. weight of boat	Column Length	Length of Battery cable	Weight	Volt
9925 028	Rhino VX 28	5 V / 2 R	800 kg	0.78 m	1.64 m	6.25 kg	12 V
9925 034	Rhino VX 34	5 V / 2 R	1100 kg	0.78 m	1.64 m	6.70 kg	12 V
9925 044	Rhino VX 44	5 V / 2 R	1350 kg	0.91 m	1.70 m	9.55 kg	12 V
9925 054	Rhino VX 54	5 V / 2 R	1750 kg	0.91 m	1.70 m	10.00 kg	12 V

The length of the motor shaft is equal to the distance between the control head and the submerged drive unit.

BEYOND COMPARISON
 • WITH LOADING
 CHECK DISPLAY*
 • WITH STEEL SHAFT
 • EXTREMELY LOW ENERGY CONSUMPTION
BEYOND COMPARISON
 * except Rhino VX 28

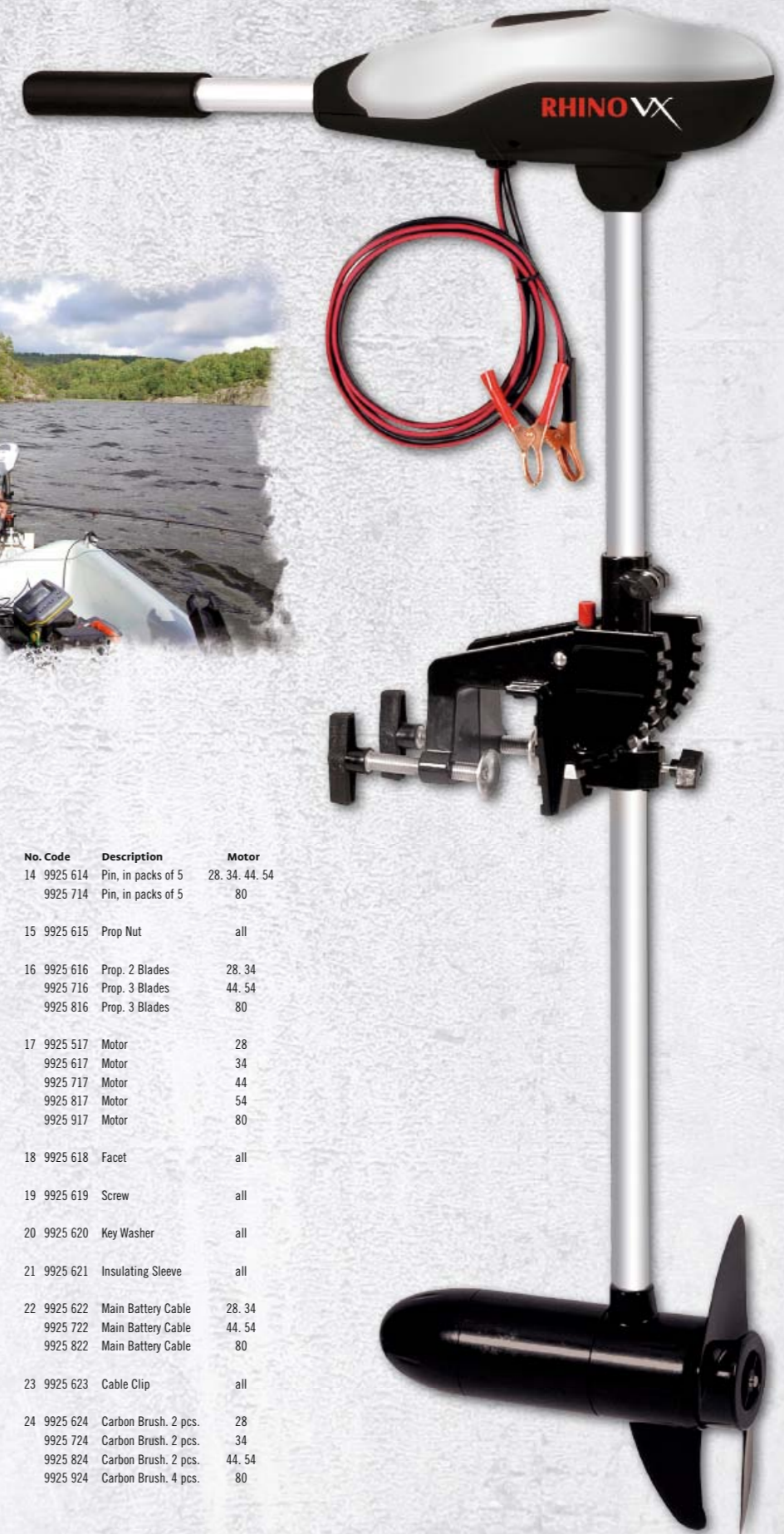

THE TECHNICAL SPECS

Description	Ampere consumption per speed	Watt per speed	Thrust (lbs)	Thrust (kp)
VX-28	1st speed: 9 A	>80	7.0 lbs	3.20 kp
	2nd speed: 11 A	100	9.2 lbs	4.20 kp
	3rd speed: 15 A	130	13.2 lbs	6.00 kp
	4th speed: 19 A	150	15.8 lbs	7.20 kp
	5th speed: 32 A	180	28.0 lbs	12.72 kp
VX-34	1st speed: 9 A	77	6.6 lbs	3.00 kp
	2nd speed: 11 A	101	7.4 lbs	3.40 kp
	3rd speed: 16 A	139	13.2 lbs	6.00 kp
	4th speed: 20 A	162	15.8 lbs	7.20 kp
	5th speed: 40 A	215	34.0 lbs	15.40 kp
VX-44	1st speed: 12 A	105	8.8 lbs	4.00 kp
	2nd speed: 14 A	126	11.0 lbs	5.00 kp
	3rd speed: 25 A	220	22.0 lbs	10.00 kp
	4th speed: 28 A	237	25.9 lbs	11.80 kp
	5th speed: 52 A	290	44.0 lbs	20.00 kp
VX-54	1. speed: 16 A	147	9.25 lbs	4.20 kp
	2. speed: 18 A	167	11.45 lbs	5.20 kp
	3. speed: 34 A	270	22.47 lbs	10.20 kp
	4. speed: 38 A	290	26.43 lbs	12.00 kp
	5. speed: 55 A	320	54.00 lbs	24.50 kp

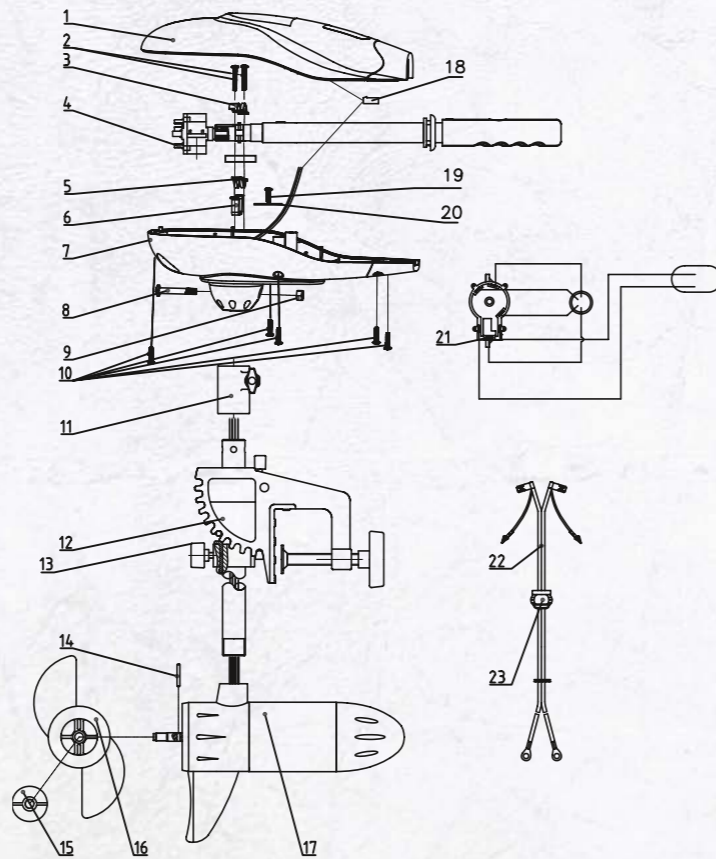

No. Code	Description	Motor	No. Code	Description	Motor
1	9925 601 Top Cover	28. 34. 44. 54	14	9925 614 Pin, in packs of 5	28. 34. 44. 54
	9925 701 Top Cover	80		9925 714 Pin, in packs of 5	80
2	9925 602 Screw. 2 pcs.	all	15	9925 615 Prop Nut	all
3	9925 603 Fixing Clamp (bottom)	all	16	9925 616 Prop. 2 Blades	28. 34
				9925 716 Prop. 3 Blades	44. 54
4	9925 604 Handle	28		9925 816 Prop. 3 Blades	80
	9925 704 Handle	34, 44, 54, 80	17	9925 517 Motor	28
5	9925 605 Fixing Clamp (top)	all		9925 617 Motor	34
6	9925 606 Pressing Wire Plate	all		9925 717 Motor	44
				9925 817 Motor	54
7	9925 607 Bottom Cover	28. 34. 44. 54		9925 917 Motor	80
	9925 707 Bottom Cover	80	18	9925 618 Facet	all
8	9925 608 Bolt	all	19	9925 619 Screw	all
9	9925 609 Locking Nut	all	20	9925 620 Key Washer	all
10	9925 610 Screw. 5 pcs.	all	21	9925 621 Insulating Sleeve	all
11	9925 611 Depth Collar	28. 34. 44. 54	22	9925 622 Main Battery Cable	28. 34
	9925 711 Depth Collar	80		9925 722 Main Battery Cable	44. 54
12	9925 612 Mount	28. 34		9925 822 Main Battery Cable	80
	9925 712 Mount	44. 54	23	9925 623 Cable Clip	all
	9925 812 Mount	80	24	9925 624 Carbon Brush. 2 pcs.	28
13	9925 613 Tension Block	28. 34. 44. 54		9925 724 Carbon Brush. 2 pcs.	34
	9925 713 Tension Block	80		9925 824 Carbon Brush. 2 pcs.	44. 54
				9925 924 Carbon Brush. 4 pcs.	80



RHINO

COBOLD

RHINO COBOLD

RHINO COBOLD OUTBOARD MOTOR

Small and manageable but effective. With its 18 lb of thrust the Cobold is designed for use with dinghies or canoes. Like its big brother, the Cobold boasts optimal power consumption enabling longer operation for the same battery capacity. Features a switch for 'forwards', 'off' and 'backwards', also offers a choice of two speeds. The propeller depth in the water and steering pressure are continuously adjustable via screws. The tiller can be lowered into the motor head to save space during transport. Finally, the shaft comes with an ingenious fastener allowing the motor to fold up should it come up against any obstacles.

Overall the Rhino Cobold handles easily, comfortably and safely.

Code	Model	Speeds	Max. weight of boat	Column Length	Length of Battery cable	Weight	Volt
9921 018	Rhino Cobold	2 V / 2 R	500 kg	0.60 m	1.60 m	2.45 kg	12 V

The length of the motor shaft is equal to the distance between the control head and the submerged drive unit.

IN PACKS OF 2

THE TECHNICAL SPECS

Description	Ampere consumption per speed	Watt per speed	Thrust (lbs)	Thrust (kp)	
T18	1st speed:	7 A	75	8 lbs	3.60 kp
	2nd speed:	15 A	120	18 lbs	8.20 kp

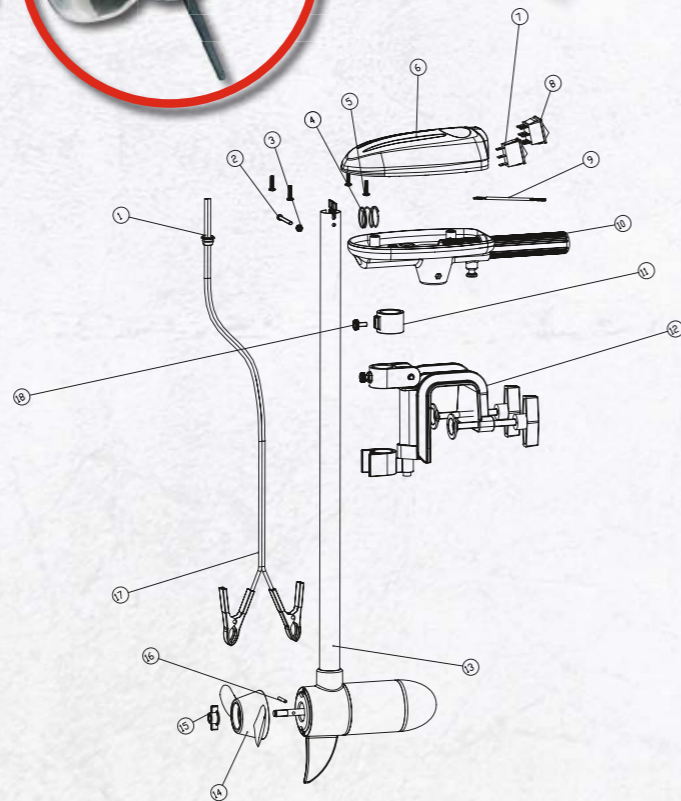

No.	Code	Description
1	9921 101	Battery cable clip
2	9921 102	Screw
3	9921 103	Locking nut
4	9921 104	Spring
5	9921 105	screw, 4pcs.
6	9921 106	Top cover
7	9921 107	Switch
8	9921 108	Switch
9	9921 109	Wire assembly
10	9921 110	Bottom cover assembly
11	9921 111	Depth collar assembly
12	9921 112	Mount assembly
13	9921 113	Motor assembly
14	9921 114	Prop
15	9921 115	Prop nut
16	9925 614	Pin
17	9921 117	Main battery wire
18	9921 118	Screw
19	9921 119	Carbon brush, 2pcs



MOTOR FUSES

Code	Model	Motor
9925 947	Set 40 A	VX28/34
9925 948	Set 50 A	VX44/54/T4/T5
9925 949	Set 60 A	VX80/T8
9925 950	40 A	VX28/34
9925 951	50 A	VX44/54/T4/T5
9925 952	60 A	VX80/T8



PROPELLER SETS THUNDER/VX

With a choice of a two or three blade propeller, supplied with a shear pin and fixing screw.

Code	Description
9925 395	Prop Key
9925 397	Propeller-Set VX28/VX34
9925 398	Propeller-Set VX44/VX54/T4/T5
9925 399	Propeller-Set VX80/T8

REPAIR KITS

With all important spare parts.

Code	Model
9925 930	Repair Kit Rhino VX28
9925 931	Repair Kit Rhino VX34
9925 932	Repair Kit Rhino VX44
9925 933	Repair Kit Rhino VX54
9925 934	Repair Kit Rhino VX80
9925 935	Repair Kit Manta MX28
9925 936	Repair Kit Manta MX34
9925 937	Repair Kit Manta MX44
9925 938	Repair Kit Manta MX54
9925 939	Repair Kit Thunder T4 / T5
9925 940	Repair Kit Thunder T8
9925 941	Repair Kit Rhino Cobold
9925 804	Speed Control Switch Upgrade Kit VX34-54

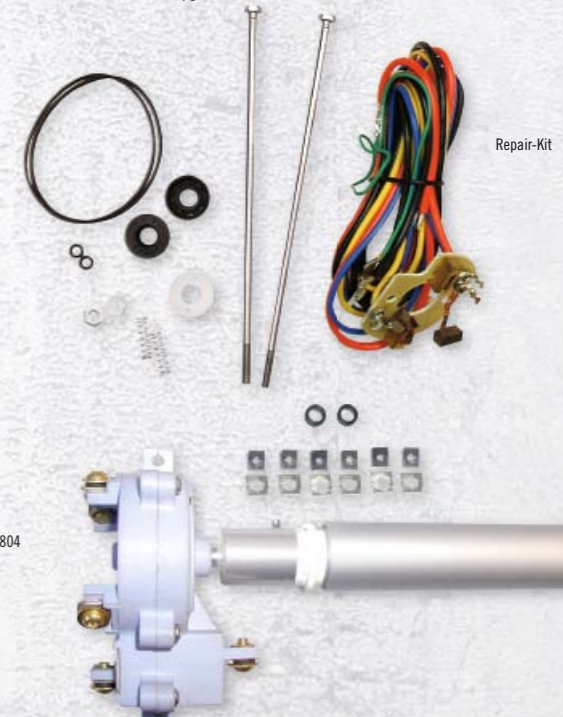

Repair-Kit

9925 804



RHINO

RHINO MOTOR DISPLAY UNIT

Ideal stand to display 2 Rhino motors.

Code	Model
9925 998	Rhino Motor Display Unit Z24920



CAP

Rhino Cap. 100 % cotton.

Code	Description
9788 030	Rhino Cap

IN PACKS OF 5



KEY STRAP

Useful. Strong RHINO! With high quality clips. Popular advertising aid.

Code	Description
9949 001	Rhino Key Strap

IN PACKS OF 10



RHINO STICKER

50 x 10 cm.

Code	Description
9971 958	Rhino Sticker

IN PACKS OF 10



RHINO STICKER

With Rhino motif. black/red

Code	Description
9949 039	Rhino Sticker 20 cm x 7 cm

IN PACKS OF 10



JAW CLAW

This fish gripper has an ultra-secure hold yet protects the fish from harm. Ideal for using from the Rhino Sharkoon Kayak when there is no landing net to hand.

Code	Description	Size
7053 001	Jaw Claw	29 cm