



BROWNING
F I S H I N G

**Perfect angling equipment and accessories for
champion anglers of the present and future. Place your trust
in the experience of a global brand whose equipment
is synonymous with quality and winning championships.**



Match Poles	Page B 3-17	Lines.....	Page B 84-85
Margin and Starter Poles	Page B 18-21	Floats.....	Page B 86-89
Whips.....	Page B 22-23	Method and Carp Feeders.....	Page B 90-91
Tele Rods.....	Page B 24-25	Open and Block-end Feeders	Page B 92-97
Pole Spare Parts.....	Page B 26-27	Weights and Accessories	Page B 98
Hybrid Specialist Rods	Page B 28-31	Swivels & Accessories	Page B 99-101
Bolognese Rod	Page B 32-33	Pole Accessories	Page B 102-103
Tele Rods.....	Page B 34-35	Seatboxes & Accessories.....	Page B 104-109
Match Rods.....	Page B 36-41	Buckets, Baitboxes & Riddles.....	Page B 110-111
Feeder Rods	Page B 42-49	Pole Rollers, Kit Roosts, Rests.....	Page B 112-117
Rod Accessories.....	Page B 50-51	Luggage, Tubes & Umbrellas.....	Page B 118-123
Reels.....	Page B 52-61	Keep Nets, Landing Nets, Net Handles.....	Page B 124-131
Hybrid Accessories.....	Page B 62-67	Clothing	Page B 132-137
Groundbait.....	Page B 68-75	Promotional items	Page B 138
Particles & Aromas	Page B 76-83		

Browning Trademarks Licensed From Browning.
All lengths and weights quoted may vary within manufacturing tolerances.



XITAN

Browning Xitan Revolution and new Xitan Power range poles: The future is here – poles will never be the same!

Browning re-wrote the rule book when it launched its revolutionary Z12 pole in 2012. The design included a series of unique features which eliminated many of the limitations - and irritations - that anglers have had to accept for so many years. Not least, no longer did anglers have to take a saw to their new pole!

The angling press and Z12 owners have been full of praise for the new pole and it has deservedly been tagged as “The best pole in the World”. The Z12’s features will inevitably be copied by other makers but, as is always the case, copies will never be as good as the originals.

For 2013 Browning has introduced a new range of Xitan poles which use the same nano-carbon technology and incorporate many of the advanced features found on the Z12. There is now a fully featured Xitan pole at every price band and for every need.

No other poles offer such performance, features, ease of use and sheer value. All poles in the new range are effectively “ready to fish” with pre-bushed topkits – just add elastic and go!

The Xitan pole range is split into two groups:



The **XITAN REVOLUTION** range uses a variable section length design including longer butt sections to achieve the ultimate in stiffness and balance. These are professional level poles for anglers looking for the ultimate in performance and willing to accept the longer transport length.



The **XITAN POWER** range uses similar materials as the Revolution poles. However, the section lengths are more conventional at 1.85m. There is a **POWER** range pole to suit most budgets and all are available at shorter lengths for anglers who want a better quality but shorter pole.

Professional level anglers to „just for pleasure“ - there’s an Xitan pole for all!



Photo: TCF/DHP Media

XITAN

What makes Browning's Xitan poles special?

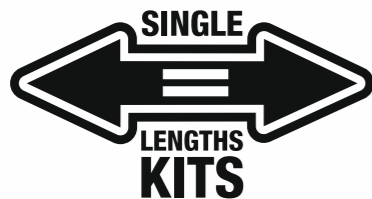

Single Length Kits – no cutting back, no bushes, just add elastic and you're fishing!

All SLK topkits are the same length and are pre-bushed with top-quality PTFE bushes, so no more cutting back or lost length. We offer 3 types of SLK (Standard, Extra-power and Long) with 4 different tip diameters to suit different sizes of elastic. There are also matching Cupping kits with screw attachments fitted. At last, no need to take a saw to your new pole! See the accessory page 12-13 for the full range of available SLKs.



At last – no cutting back

Xitan poles do not need any cutting back for even the largest elastics so no waste or lost length.



Pole Protection System – protect sections from damage

Pole Protectors are purpose designed short butt sections. Each of the PPs is designed as an integral part of the pole, has built-in skid bungs and is reversible, therefore fits 2 sections. There are 3 PPs for each pole range and they fit every section from the 5th through to the 16m butt sections. They protect the main sections (particularly useful on the 5th & 6th sections) and give useful length options if fishing to islands or features.



Nano-Carbon Construction – strong and light, but not brittle

The high-modulus carbon needed to make a pole light and stiff can often be brittle. The pole is strong but a "knock" against something hard or dropping a section can result in breakage. We use Nano-carbon fibres, which makes the sections much more durable!



Precision Points – accurate feeding is important to success

The butt sections of all Xitan poles have a series of full diameter markings which allow consistent and accurate fishing and feeding when using a pole cup.



Strengthened Stress Points – designing out weak spots

Xitans have visibly strengthened grip areas on the middle sections and also on the elbow areas of the butt sections. These resist crushing when unshipping and cracking when striking. They look good too!



Section Alignment Points – for maximum stiffness

All sections have alignment arrows for maximum rigidity. Sections are also numbered for identification and carry a part number so if you need to order a replacement you will always get the correct section.



Overwrapped Joints – designing out wear

The top-end Xitans have carbon overwrapped male and female joints to resist premature wear and chipping. The overwrap on the female joints also increases hoop strength which helps unshipping when the pole is under load.



Diamond Surface Finish – smooth and fast shipping

Xitan pole sections have a special diamond ground surface finish for easy "non-stick" shipping in and out. Wet or dry, the Xitans are very "fast" poles to fish with. We also use the minimum of paint to reduce weight and minimise "sticky" areas on butt sections.



Premium Protection Tubes

Xitan poles and SLK topkits are supplied in premium quality protective tubes. These resist both cracking in low temperatures and distortion in high temperatures. Your valuable pole deserves the best protection available.





Xitan Revolution Z12

Z12 Revolution – we've been told that it's "The best pole in the World" - and we agree!

The Z12 Revolution caused a real stir in the pole market when introduced for 2012. No other pole on the market offers so many features, combined with the optimum balance between stiffness, strength and weight.

The Z12 is an ultra high performance, professional level competition pole for anglers who take their sport seriously and demand the best. A top-seller in 2012, it has firmly established itself at the top.

The Z12 is ultra stiff when striking or fishing in side winds, but has been designed to have some "action" in the middle sections when under extreme load to absorb the pressure from hard fighting fish and over enthusiastic strikes. The Z12's rigidity makes it unmatched

for fishing fast or long for shy biting fish. However, fitted with the supplied power C section it can be a real "bagging" tool.

The Z12 is a true length at 16m (remember no cutting back) and extends to 16.8m as standard with the supplied Pole Protector 3 fitted.

Available in a comprehensive 16.8m package or the huge 18.6m "Pro" package.

Adam Richards (GB)



Code	Model	Length	Sections	Tr.-Length	Weight
1739 130	Xitan Z12 13 m + P. Protector	13.00 m	8	1.95 m	827 g*
1739 998	Extension 14.5 m	1.95 m	1	1.95 m	270 g
1739 999	Extension 16 m / 17.5 m	1.95 m	1	1.95 m	310 g
1739 988	Pole Protector I (5/6)	1.00 m	1	1.00 m	161 g
1739 989	Pole Protector II (7/8)	1.00 m	1	1.00 m	232 g
1739 990	Pole Protector III (9/10)	1.00 m	1	1.00 m	237 g
1739 992	SLK Ultra Match 3.0 mm	2.60 m	2	1.45 m	40 g
1739 993	SLK Match 3.9 mm	2.60 m	2	1.45 m	40 g
1739 984	SLK Carp 4.5 mm	2.60 m	2	1.45 m	40 g
1739 985	SLK Carp XL 5.5 mm	2.60 m	2	1.45 m	41 g
1739 986	SLK Match Puller 3.9 mm	2.60 m	2	1.45 m	48 g
1739 994	SLK Carp Puller 4.5 mm	2.60 m	2	1.45 m	45 g
1739 995	SLK Carp XL Puller 5.5 mm	2.60 m	2	1.45 m	46 g
1739 991	SLK Cupping Kit 2/1	2.60 m	2	1.45 m	50 g
1739 996	Kit 4/1 3.9 mm	5.50 m	4	1.58 m	161 g
S173923	Xitan Revolution Power C	1.50 m	1	1.50 m	240 g
1739 904	Z12 Short C	0.75 m	1	0.75 m	33 g

* plus Pole Protector



See the full range of Xitan compatible topkits and accessories on pages B12 & B13.

Xitan Revolution Xtreme Margin 9.5 m

The new Revolution Xtreme Margin is, as its name suggests, a high quality, strong, durable pole for margin and "short" fishing. The middle sections have increased wall strength and visible reinforcing, yet the pole is still "Xtremely" light.

The pole is supplied with our unique 1m Pole Protector butt section, which fits the pole at 7 and 8.5m to absorb the "knocks and bangs" inevitable when catching big fish and big weights.

The Xtreme Margin is fully section compatible with all Xitan Revolution and Power range poles, so it is a perfect partner for summer fishing.

Comes supplied with the largest 5.5mm tip diameter SLK P kits so will take the largest hollow elastics without any cutting back and lost length.

Code	Model	Length	Sections	Tr.-Length	Weight
1885 950	Xitan Xtreme Margin	9.50 m	6	1.75 m	475 g



Bob Nudd (GB)



Xitan Z9

Xitan Z9 – proven performance, proven quality, proven reliability, outstanding value

Browning's Xitan Z9 pole is generally recognised as one of the best all-round poles on the market with a perfect balance between strength, weight and stiffness. The Z9 has built a loyal following and has "converted" many anglers to Browning poles. The Z9 is too good to lose so continues into 2013 to lead Browning's new range of Xitans.

The Z9's overall performance is a match for any top-end pole on the market today, including our own Z12 - which has the Z9 in its DNA!

However, no other top-end pole offers so much value-for-money and sheer all-round ability.

The Z9 is a well proven, reliable pole that has already become a „classic“ - like so many previous Browning poles.

Available in a comprehensive 16m package or the popular and huge 18m "Pro" package.

Code	Model	Length	Sections	Tr.-Length	Weight
1736 130	Xitan Z9 13 m + Mini Ext.	13.00 m	9+1	1.75 m	840 g*
1736 998	Extension 14.5 m	1.75 m	1	1.75 m	263 g
1736 999	Extension 16 m / 17.5 m	1.75 m	1	1.75 m	272 g
1736 995	Match Kit 3/1	3.20 m	3	1.45 m	42 g
1733 995	Power Match Kit Concept	3.20 m	3	1.46 m	34 g
1736 996	Kit 4/1	4.60 m	4	1.50 m	91 g
1736 997	Kit 5/1	6.10 m	5	1.60 m	167 g
1736 990	Mini Extension 11.5 m / 13 m	0.90 m	1	0.90 m	169 g
1736 991	Mini Extension 14.5/16/17.5 m	0.90 m	1	0.90 m	185 g

* plus Miniextension



See the full range of Xitan compatible topkits and accessories on pages B12 & B13.

Bob Nudd (GB)



Xitan Z8

Xitan Z8 – the new pole so many anglers have been asking Browning for! Many experienced anglers prefer some extra strength in their top-end pole. Perhaps they fish mainly on commercial fisheries or powerful rivers, perhaps they are just inclined to be a little "heavy handed" and give their poles a hard life!

Recognising this, we have produced the new Xitan Z8. Based on our highly successful Z9, the Z8 uses a slightly different Nano-carbon mix, which adds strength but very little extra weight. This superbly strong and stiff pole is the perfect choice for serious competition anglers looking for a top quality, "do-all workhorse",

suitable for everything from small fish to demanding commercial fishery or river fishing situations.

The new Xitan Z8 has the complete range of advanced features we build into our flagship Z12 pole – top-end features at a mid-range price.

Available in either a true length 16m "Pro" package, or a smaller 14.5m Std package for those who do not need or want a longer pole. Both are supplied with our highest quality pre-bushed SLK kits - puller or standard - the choice is yours.

Code	Model	Length	Sections	Tr.-Length	Weight
1883 131	Xitan Z8 13 m	13.00 m	8	1.75 m	834 g*
1883 998	Extension 14.5 m	1.85 m	1	1.76 m	288 g
1883 999	Extension 16 m	1.85 m	1	1.76 m	300 g
1883 996	Kit 4/1, 3.9 mm	5.95 m	4	1.59 m	166 g

* plus Pole Protector



Xitan Z6

Xitan Z6 – top-end pole performance for a mid-range price! The new Xitan Z6 provides the same superb quality, the same technology and the same advanced features as the most expensive Xitans, but at a truly mid-range price. Never before has so much sophistication been available to anglers buying in this price band.

As you would expect from a Browning pole, the Z6 is very strong and can cope with any style of fishing. However, by using our advanced Nano-carbon technology we have been able to keep weight down. Unlike so many poles in this price range, the Z6 is well balanced and

genuinely useable for long sessions at full 16m length - and at 14.5 meters it's an absolute dream!

A durable pole, the Xitan Z6 will give many years trouble-free service. Low cost spares and topkits also keep the cost of ownership reasonable.

Available in either a true length 16m "Pro" package, or a smaller 14.5m standard package for those who do not need or want a longer pole. Supplied with a useful mix of pre-bushed SLK topkits to cover a wide range of uses.

Code	Model	Length	Sections	Tr.-Length	Weight
1882 131	Xitan Z6 13 m	13.00 m	8	1.75 m	893 g*
1882 998	Extension 14.5 m	1.76 m	1	1.75 m	310 g
1882 999	Extension 16 m	1.76 m	1	1.75 m	338 g
1882 996	Kit 4/1, 3.9 mm	5.95 m	4	1.59 m	168 g

* plus Pole Protector



Xitan Z Ultra Power

Xitan Z Ultra Power – a very tough pole for very tough situations! As its name suggests, the new Xitan Z Ultra Power has been specially designed for big fish and big catch situations. The Ultrapower middle sections have an extra, very distinctive and visible, spiral carbon wrap layer which significantly increases section wall strength. This method of strengthening has allowed us to keep the pole's weight reasonable and therefore the Ultrapower is lighter than usual for poles with this level of strength.

The pole is built on the same mandrel and includes many of the advanced features found on the more expensive Xitan poles so the

Ultrapower is not the typical crude and heavy "power" pole. If ultimate strength and reliability are what you're looking for – with just a bit more "class" - then the new Ultrapower is the pole for you!

Available in either 14.5m Pro or smaller 13m packages, but can be extended to 16m by using an extra extension. The pole is supplied with the large 5.5mm tip diameter, pre-bushed, SLK Power topkits that will take the thickest elastics. And remember, no cutting back means no lost length.

Code	Model	Length	Sections	Tr.-Length	Weight
1881 131	Xitan Z Ultra Power	13.00 m	8	1.75 m	1057 g*
1881 999	Extension 14.5/16 m	1.85 m	1	1.75 m	324 g
1881 996	Kit 4/1, 3.9 mm	6.00 m	4	1.59 m	198 g

* plus Pole Protector



Xitan Z Allrounder

Xitan Z Allrounder – Need one pole that does everything? – this is it! The new Xitan Z Allrounder is exactly that ... a stiff, very light weight but strong pole, "ready-to-go" with pre-bushed topkits, that can be used for any style of fishing – big fish, small fish, rivers, lakes, the new Allrounder will do it all with ease.

It really is the perfect pole for most anglers – light in weight, easy and quick to elasticate (no cutting or bushes needed), amazing value packages, low cost spares - and all from a top quality brand you can trust for quality and service.

Never has a pole in this price range been offered with so many features from our top-end models. This Allrounder compares well with poles costing twice as much.

Available in either 14.5m Pro or smaller 13m packages to suit different needs and budgets. Can be extended to 16m by using an extra extension. Supplied with Pole Protection section and a useful mix of pre-bushed SLK topkits.

Code	Model	Length	Sections	Tr.-Length	Weight
1880 131	Xitan Z Allrounder	13.00 m	8	1.75 m	990 g*
1880 999	Extension 14.5/16 m	1.85 m	1	1.75 m	324 g
1880 989	Pole Protector II Z Allrounder	0.85 m	1	0.85 m	285 g
1880 996	Kit 4/1, 3.9 mm	6.00 m	4	1.49 m	163 g

* plus Pole Protector



XITAN power

Generic Xitan Items

COMPATIBILITY GUIDE

These Xitan pole accessories fit:

All current Xitans: Z12, Z9, Z8, Z6, Ultra Power, Allrounder, Xtreme Margin

Previous models: Z7.5, Z7, Z4.5, Z4, Z3, Z2, Z1, Xitan Carp

Some other Browning poles: Sniper Carp, Sniper Combat Carp, Carboxy Gold II (topkits only)

All Browning topkits have a 22mm joint size and will fit a wide range of non-Browning poles. Your Zebco representative will be able to confirm which poles they fit.



Single Length Kits

SLK – no cutting back, no bushes, just add elastic and you're fishing!
All pre-bushed with top-quality PTFE bushes. Up to 4 different tip sizes for different elastics and matching cupping kits with attachments fitted. Sections are compatible so can be swapped between kits.

- Standard SLK's: as supplied with our top-end poles. Carefully selected carbon ensures they are very stiff, light, yet strong enough for all except extreme fishing situations. At 2.6m, the perfect length for elastication and landing fish. 2 hole Tension Puller versions of the larger sizes available.
- Long SLK's: are 3.0m versions specifically designed for fishing in deep water where longer top 3's or 4's are required. 2 tip diameters, plus matching cupping kit.

- Power SLK's: all the same SLK features but made in a different grade of carbon which provides some additional strength when situations require. Includes extra strong cupping kit.

Elastic fitment guide for each tip diameter:

- 3.0mm Ultramatch - for solid elastics up to No 6 / 1.0mm
- 3.9mm Match - for solid elastics up to No 12 / 1.6mm and light hollow elastics
- 4.5mm Carp - for solid elastics up to No 16 / 2.1mm and medium hollow elastics
- 5.5mm Carp XL - for medium and large diameter hollow elastics



Code	Model	Length	Sections	Tr.-Length	Weight
1883 984	3.0 m 2/1 SLK L. 3.9 mm	3.00 m	2	1.60 m	45 g
1883 985	3.0 m 2/1 SLK L. 4.5 mm	3.00 m	2	1.60 m	46 g
1883 986	3.0 m 2/1 SLK L. Cupping Kit	3.00 m	2	1.60 m	54 g
1883 992	2.6 m 2/1 SLK P. 3.9 mm	2.60 m	2	1.45 m	50 g
1883 993	2.6 m 2/1 SLK P.4.5 mm	2.60 m	2	1.45 m	51 g
1883 994	2.6 m 2/1 SLK P. 5.5 mm	2.60 m	2	1.45 m	52 g
1883 995	Cupping Kit	2.60 m	2	1.45 m	52 g



Pole Protectors

Xitan Power Range Pole Protectors (PP)

Purpose designed short butt sections. Pole Protectors are reversible and fit every section from the 5th* through to the 17.5m butt. Built-in skid bungs protect sections from chipping and cracking. Also give useful pole length options. These Pole Protectors are fully compatible with previous Xitan poles like the Z9. The Z12 Pole Protectors are listed in the Revolution Pole range pages.

Code	Model	Length	Sections	Tr.-Length	Weight
1883 988	Power-PP1	0.75 m	1	0.75 m	113 g
1883 989	Power-PP2	0.65 m	1	0.65 m	210 g
1883 990	Power-PP3	0.75 m	1	0.75 m	270 g

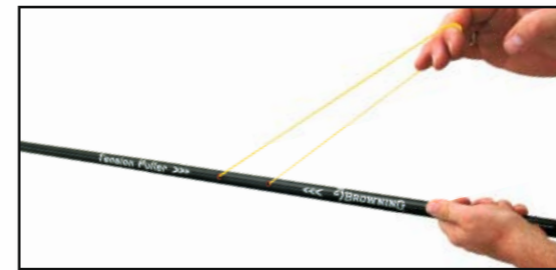

Xitan Tension Puller Kit

Browning's Tension Puller provides the "side puller" facility but with the advantages of conventional winderbung elastic tensioning. Eliminates the limitations and waste caused fixed length elastic systems. Light and strong, does not unbalance a pole and big bore tip so does not need cutting back.

Code	Model	Length	Sections	Tr.-Length	Weight
1733 991	Tension Puller Kit L	2.60 m	2	1.45 m	35 g



Xitan Power Short 3rd Section*

This section significantly stiffens the pole for fishing with short lines or in strong crosswinds. The Z12 short section is listed in the Revolution Pole range pages.

Code	Model	Length	Sections	Tr.-Length	Weight
1883 904	Power short C	0.75 m	1	0.75 m	33 g

*replaces 4th section on Z9 and older Xitan poles



Xitan Power 3rd Section*

A low cost, full length, section that's virtually the same weight as the original, but in a different carbon mix to add some strength and durability. The Z12 power section is listed in the Revolution Pole range pages.

Code	Model	Length	Sections	Tr.-Length	Weight
1883 903	Xitan Power 4th Section	1.50 m	1	1.50 m	40 g

*also used and recommended as a power 4th section for the Z9



Xitan Full Length Powerkit

A very strong conventional powerkit. Ideal for anglers needing something stronger than the PMK. If used on a Z12 or Z9 we recommend that the Power 3rd sections are used to balance the extra strength.

Code	Model	Length	Sections	Tr.-Length	Weight
1733 993	Xitan 2 piece Powerkit	3.20 m	2	1.66 m	61 g



Power Match Kits (PMK)

Purpose designed to be used as Power Kit or Match Kit. Similar carbon as our top-end poles so superbly light and stiff. With the tip section in place perfect for elastics to 6 (1.0mm). With tip removed becomes a very light, 2.6m Power Kit. Try these and you will never use a conventional Power Kit again!

Code	Model	Length	Sections	Tr.-Length	Weight
1733 995	Power Match Kit Concept	3.20 m	3	1.46 m	34 g



Xitan Standard Cupping Kit

An ultra strong and very stiff two piece Cupping Kit with a large tip diameter to take a cup fitting.

Code	Model	Length	Sections	Tr.-Length	Weight
1733 992	Xitan Cupping Kit 2/1	3.20 m	2	1.66 m	59 g

Carboxy Gold II

Carboxy Gold – a licence to win! Our most successful match pole of the last decade has been given a complete upgrade to incorporate the latest developments in pole technology.

- The top three sections have been re-designed in line with the tried and trusted Power-Match-Kit concept of the Xitan Power Poles. A larger diameter A section gives anglers a longer effective pole length.
- The male and female joints have been visibly reinforced with woven carbon mat considerably reducing joint wear and edge damage that comes with years of use.
- The 6th to 8th sections have been re-designed by optimising the direction of the carbon mat giving the new Carboxy Gold II a little extra stiffness.
- Pole weight has been further reduced by moving away from the all-over gold lacquer on the lower sections.

The 'old' Carboxys were strong, thoroughbred poles whose reputation stood the test of time. The new Carboxy Gold II is a seamless continuation of the success story.

The single mandrel concept of the former Beryllium poles has been retained, meaning continued high levels of compatibility with top kits, individual sections and accessories. The Gold top kits (i.e. for kits 3/1, power kits 2/1 and cupping kits), are also compatible with the Xitan Power range – (and vice-verse) giving further kit options for Carboxy Gold users.

All Browning poles on this page are supplied with the same grade of carbon in their kits as on the pole, we do not substitute quality or cut any corners.

Code	Model	Length	Sections	Tr.-Length	Weight
1622 130	Carb. Gold II 13 m + Mini Ext.	13.00 m	9	1.80 m	920 g*
1622 998	Extension 14.5 m	1.80 m	1	1.80 m	310 g
1622 999	Extension 16 m	1.80 m	1	1.80 m	325 g
1622 995	Kit 3/1	3.10 m	3	1.45 m	42 g
1622 997	Kit 5/1	6.00 m	5	1.49 m	155 g
1622 990	Mini Extension 11.5 m / 13 m	0.75 m	1	0.75 m	248 g
1622 991	Mini Extension 14.5 m / 16 m	0.75 m	1	0.75 m	248 g

* plus Miniextension

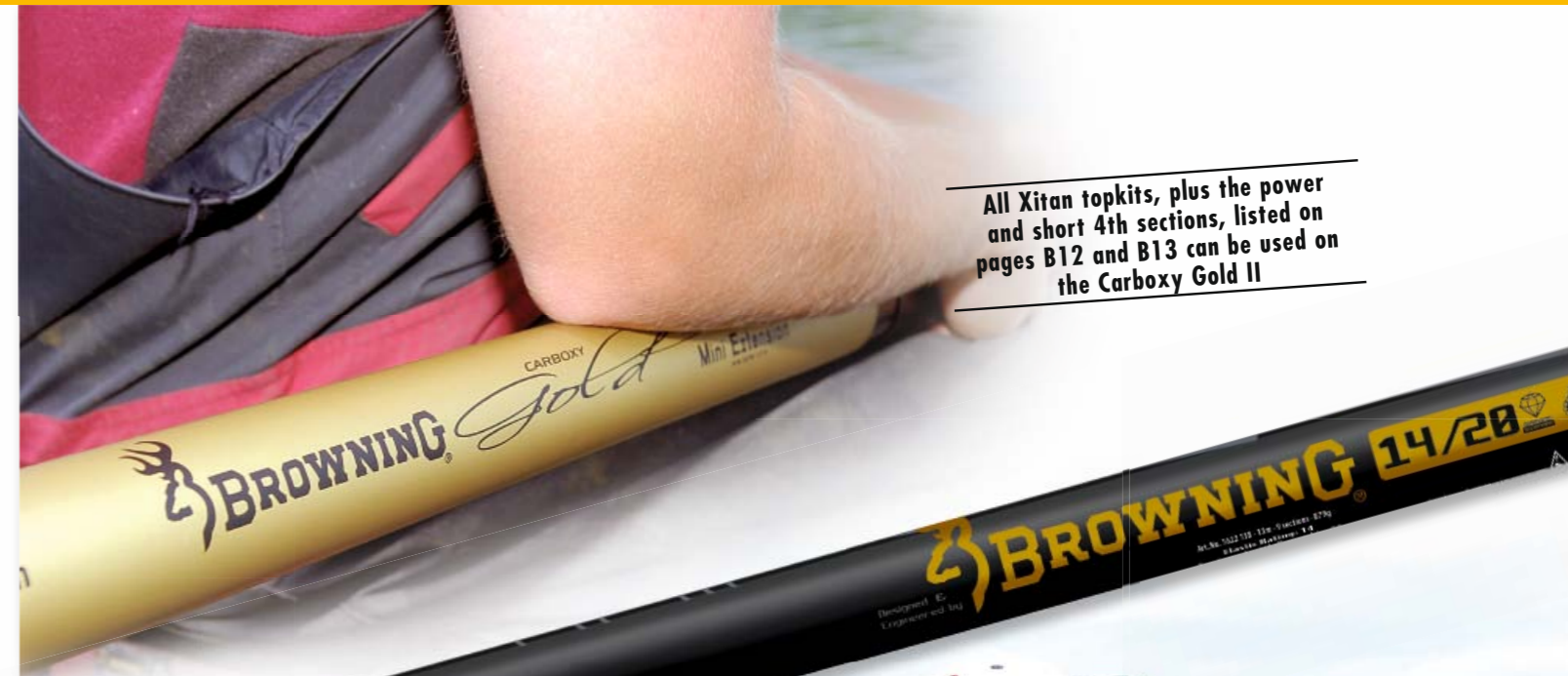

All Xitan topkits, plus the power and short 4th sections, listed on pages B12 and B13 can be used on the Carboxy Gold II



Simon Achhammer (D)

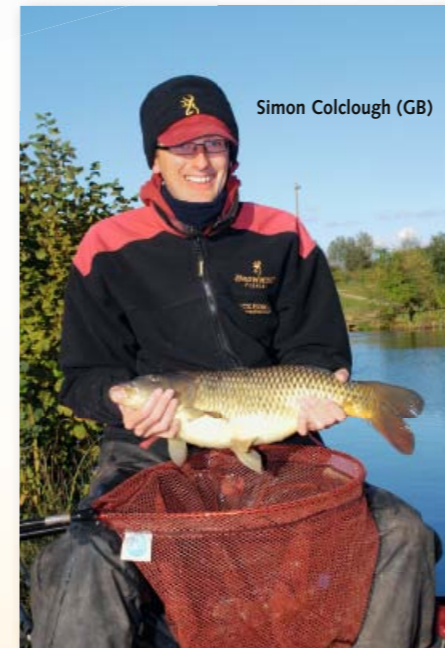

Simon Colclough (GB)



Albert Wiederer (D)

Sniper & Sniper Combat

The Sniper Pole series builds on the success of the famous Xitan "Z" Poles. Available at 11 and 13 metres, the poles include many of the Xitans' advanced design features but at very competitive prices.

The Sniper Poles are light and, more importantly, have excellent balance which eliminates the top-heavy feel found on many lower cost poles. The poles have been purpose designed at these lengths and are not produced by simply adding or removing sections from other models.

The Snipers are strong and durable making them truly "multi-purpose" poles. They are suitable for all forms of fishing - lakes, rivers or commercial fisheries; hard fighting Carp and Barbel, big Bream to

small Roach; match fishing or just a nice day at the waterside ... the Snipers will do it all!

The Sniper Combat model has been built using a higher modulus carbon cloth which has reduced the weight of the pole even further, while retaining its strength. It has been included for anglers prepared to spend just a little more for a lighter version of the pole.

The Snipers are top-kit compatible with the Xitan range so the Xitan Power Kits, Power Match Kits and the unique Tension Puller kits are fully interchangeable with both poles.

Sniper Combat Carp

Code	Model	Length	Sections	Tr.-Length	Weight
1630 110	Sniper Combat Carp 11 m	11.00 m	8	1.73 m	792 g
1640 990	Mini Extension 11.5/13.0 m	0.90 m	1	0.90 m	239 g
1640 991	Mini Extension 10.0/11.5 m	1.00 m	1	1.00 m	273 g
1640 993	Power Kit 2/1	2.70 m	2	1.39 m	56 g
1640 995	Kit 3/1	3.28 m	3	1.45 m	46 g
1630 997	Kit 5/1	6.09 m	5	1.49 m	205 g
1630 999	Extension 13 m	1.75 m	1	1.75 m	349 g

* + Miniextension



Sniper Carp

Code	Model	Length	Sections	Tr.-Length	Weight
1640 110	Sniper Carp 11 m	11.00 m	8	1.73 m	878 g
1640 990	Mini Extension 11.5/13.0 m	0.90 m	1	0.90 m	239 g
1640 991	Mini Extension 10.0/11.5 m	1.00 m	1	1.00 m	273 g
1640 993	Power Kit 2/1	2.70 m	2	1.39 m	56 g
1640 995	Kit 3/1	3.28 m	3	1.45 m	46 g
1640 997	Kit 5/1	6.09 m	5	1.49 m	215 g
1640 999	Extension 13m	1.75 m	1	1.75 m	345 g

* + Miniextension





Black Magic Slimstar

Over many years, the Black Magic name has been synonymous with incredibly strong poles that other makers have never been able to match. This continues with the new Black Magic Slimstar. This slim diameter pole is an absolute joy to use, particularly for anglers who dislike or find modern „fat“ poles difficult to handle. The pole is „ready-to-use“ with pre-bushed topkits that do not need cutting back and is supplied with one of our innovative Pole Protector sections as used on our top-end poles. Is the Slimstar strong? What would you expect from a pole carrying the Black Magic name !

Code	Model	Length	Sections	Tr.-Length	Weight
1890 110	Black Magic Slimstar	11.00 m	8	1.70 m	876 g
1890 999	Extension 10/11 m	1.10 m	1	1.10 m	200 g
1890 993	Kit 2/1	1.95 m	2	1.02 m	27 g



Black Magic Pro

As you would expect from something bearing the famous Black Magic name, this pole is strong enough for just about every fishing situation. Despite its strength, the BM Pro is still amazingly light when compared to other poles in this price range so it's also an excellent all-rounder for general pole fishing. Using a special carbon mix, the Pro is also very tough and perfectly suited for less experienced anglers or for those who are a little „heavy handed“ with poles.

Code	Model	Length	Sections	Tr.-Length	Weight
1806 800	Black Magic Pro Canal	8.00 m	6	1.73 m	510 g
1806 950	Black Magic Pro Canal	9.50 m	7	1.73 m	750 g
1806 999	Extension 11 m	11.00 m	8	1.73 m	395 g
1806 993	Kit 2/1	1.90 m	2	1.30 m	25 g
1806 995	Kit 4/1	4.70 m	4	1.46 m	161 g



Trail Blazer Strong

A real „all-round“ 11 metre pole offering exceptional performance and value for money. We have carefully designed the Trailblazer using modern techniques to give the pole the reserves of strength that are essential in modern fishing, but without adding too much weight. The result is a light and stiff pole suitable for every style of fishing and every level of experience. Package includes an additional powerkit. Spares and topkit prices have been kept reasonable.

Code	Model	Length	Sections	Tr.-Length	Weight
1133 110	Trail Blazer Strong*	11.00 m	9	1.60 m	1098 g
1133 993	Power Kit 2/1	2.95 m	2	1.50 m	90 g

*incl. Power Kit 2/1

Merida 950

Built to the same „state of the art“ performance and quality standards as our Trailblazer Strong, but at a shorter length and lower price. Like its slightly longer brother, a real „all-rounder“ suitable for every style of fishing and every size of fish. Package includes an additional powerkit.

Code	Model	Length	Sections	Tr.-Length	Weight
1053 950	Merida 950*	9.50 m	8	1.60 m	810 g
1053 993	Power Kit 2/1	2.95 m	2	1.50 m	90 g

*incl. Power Kit 2/1



Thomas Rimpl (D)

Browning was the first to develop and sell extra-strong poles for fishing for the big fish close to the bank. Other makers followed our lead and the choice in „Margin Poles“ is now huge. However, Browning’s vast experience shows in the superior design, quality and strength of our latest models. We have also applied the same top quality and design standards to our ranges of low-cost poles.



All Browning poles on this page are supplied with the same grade of carbon in their kits as on the pole, we do not substitute quality or cut any corners.



Handle fits both Parallel Extension ...



... and B-Section



Packed in clear presentation tube with full colour „Introduction to Pole Fishing Guide“ and a Bob Nudd DVD.

Drag' N Net

Re-introduced by popular demand but with performance improvements and a modern look. This version of our famous “Drag n Net” margin pole will not disappoint. Slim, light but incredibly strong it will handle those “zoo creatures” that lurk in the margins. The thick tip needs no cutting back for heavy elastics.

Code	Model	Length	Sections	Tr.-Length	Weight
1209 550	Drag' N Net	5.70 m	5	1.63 m	350 g
1209 993	Kit 2/1	2.45 m	2	1.43 m	59 g

Margin Mauler

Our totally unique “hit ‘n hold” margin pole that has gained the reputation as being the strongest margin pole on the market. Any size of fish and any size of elastic – the Mauler will handle it! The Mauler has a parallel middle section which can be added or removed to allow the handle section, which has slip-proof EVA grips, to be used at 2 different lengths. The tip section has a big diameter and needs no cutting back for the strongest elastics on the market.

Code	Model	Length	Sections	Tr.-Length	Weight
1873 400	Margin Mauler 4 m	4.00 m	4	1.07 m	279 g
1872 500	Margin Mauler 5 m	5.00 m	4	1.34 m	410 g

Pit Bull Pre-elasticated pole packs

“Ready to go” strong poles – just attach a pole rig and you’re ready to fish! Available at 4 & 6 meters, both poles are strong but not too heavy. The 4m Pit Bull is fitted with elastic suitable for 4 to 8lb line and hard-fighting fish like carp and tench. The 6m version includes an extra top-kit with lighter elastic for suitable for smaller fish like perch and bream. Both poles come in a rigid protective carry tube and with a full colour „Introduction to Pole Fishing Guide“ and a Bob Nudd DVD.

Code	Model	Length	Sections	Tr.-Length	Weight
1871 400	Pit Bull + 2/1 Kit	4.00 m	4	1.17 m	240 g
1871 600	Pit Bull + 2/1 Kit	6.00 m	6	1.17 m	550 g
1871 994	Top 2 Kit not elasticated	2.00 m	2	1.00 m	64 g



Peter Hansen (DK)





A selection of poles that cater for all disciplines and budgets. Popular 2012 models were the Pitbull 6m & Big Fish 8m, and we expect again for these poles to be on the wish list of many more anglers.



Activate

A 11m pole for the mass market, with fresh and modern graphics that will make you stand out on the bank. An excellent choice for anglers who want to step up and fish at 11m, the ideal starter pole which will wet the appetite of many aspiring anglers.

Code	Model	Length	Sections	Tr.-Length	Weight
1131 110	Activate 11.0 m	11.00 m	7	1.65 m	1450 g
1131 994	Power Kit 2/1	2.10 m	2	1.35 m	25 g



Big Fish

The name says it all ! A set of strong "specimen" poles in 3 lengths that will do just about everything – margin work, fishing to hand, newcomers to pole fishing, those who don't want or need to fish with a longer pole. Light and strong, they will take a lot of misuse and abuse. All have a large tip diameter so will take heavy elastics without cutting back. Brilliant quality and brilliant value.

Code	Model	Length	Sections	Tr.-Length	Weight
1408 400	Big Fish 4	4.50 m	4	1.42 m	387 g
1408 600	Big Fish 6	6.00 m	5	1.44 m	541 g
1408 800	Big Fish 8	8.00 m	7	1.45 m	950 g
1408 993	Kit 2/1	2.00 m	2	1.34 m	57 g



Ambition Thunder

Beginner's carbon whip at a surprisingly low price. Ideal for beginners and youngsters alike who want a light pole to enter the world of whip angling. Ideal when short range fishing is the order of the day.

Code	Model	Length	Sections	Tr.-Length	Weight
1287 600	Ambition Thunder	6.00 m	6	1.13 m	454 g
1287 700	Ambition Thunder	7.00 m	7	1.13 m	647 g



Ambition X-Cite

Entry level whip in carbon composite material. Ideal for newcomers and youngsters, the whip's unique material characteristics combine the lightness of carbon with the robustness of fibreglass, making it more forgiving to the occasional beginner angler's error.

Code	Model	Length	Sections	Tr.-Length	Weight
1298 700	Ambition X-Cite	6.50 m	5	1.55 m	530 g
1298 800	Ambition X-Cite	8.00 m	6	1.55 m	850 g
1298 994	Kit 2/1	2.20 m	2	1.33 m	23 g



Telescopic poles manufactured with the same 'crafted for excellence' strategy. This year's range now includes the 'Black Magic Tele', and with this name you can be sure as thousands of previous anglers can verify, you will never be disappointed.



Teresa & Susana Siles Álvarez (E)



Black Magic Tele

By popular demand, we are delighted to introduce a range of slim telescopic whips covering the entire length range from 5 to 10 m. Fishing to hand is far from out-dated and the technique is still unbeatable for speed and long-line fishing. These Black Magic Whips have just the right action, through all the lengths, thanks to the efforts of Browning test anglers over a one year test program.

Code	Model	Length	Sections	Tr.-Length	Weight
1569 500	Black Magic Tele 500	5.00 m	5	1.30 m	96 g
1569 600	Black Magic Tele 600	6.00 m	6	1.30 m	142 g
1569 700	Black Magic Tele 700	7.00 m	7	1.30 m	192 g
1569 800	Black Magic Tele 800	8.00 m	8	1.30 m	252 g
1569 900	Black Magic Tele 900	9.00 m	8	1.45 m	295 g
1569 100	Black Magic Tele 1000	10.00 m	9	1.45 m	424 g

Merida Power Tele

Strong and durable telescopic carbon rods in a range of the most popular lengths. The Merida Power Tele has an action and power enough to comfortably land even large and hard-fighting fish.

Code	Model	Length	Sections	Tr.-Length	Weight
1537 400	Merida Power Tele 400	3.80 m	4	1.20 m	175 g
1537 500	Merida Power Tele 500	4.80 m	5	1.22 m	220 g
1537 600	Merida Power Tele 600	5.80 m	6	1.25 m	332 g
1537 700	Merida Power Tele 700	6.80 m	7	1.26 m	400 g

Ambition Tele

Attractive telescopic in the mid-price segment. With the type of high-calibre action demanded by experienced telescopic pole fans; ideal for collecting small fish efficiently and countering stronger opponents.

Code	Model	Length	Sections	Tr.-Length	Weight
1709 500	Ambition Tele	5.00 m	5	1.41 m	220 g
1709 600	Ambition Tele	6.00 m	6	1.41 m	320 g
1709 700	Ambition Tele	7.00 m	7	1.41 m	400 g

Merida Tele

The value alternative for the occasional pole angler. With a higher fibreglass content in the rear sections the model is a price-crusher and, thanks to the combination of materials, can withstand the occasional mishandling by the inexperienced angler.

Code	Model	Length	Sections	Tr.-Length	Weight
1530 400	Merida Tele	4.00 m	5	1.17 m	200 g
1530 500	Merida Tele	5.00 m	6	1.17 m	340 g
1530 600	Merida Tele	6.00 m	7	1.17 m	480 g

POLE SPARE PARTS



Browning's spares service is amongst the best in the industry. We keep spares for all current and many discontinued, poles for at least 5 years. We aim to keep prices reasonable and can offer a rapid delivery service. We operate a helpline (poles@zebco-europe.com) for consumers having difficulty obtaining pole spares. Enquiries are answered by our service team and sales directed to the consumer's nearest Browning stockist.



2013 RANGE	A/1	B/2	C/3	D/4	E/5	F/6	G/7	H/8	I/9 / Butt	J/10 / Butt	Butt
XITAN Z12	S173911	S173912	S173913	S173914	S173915	S173916	S173917		S173990(13m)		
A-PARTS Z12	S173911(3.0mm)	S173921(3.9mm)	S173931(4.5mm)	S173941(5.5mm)	S173951(Cup)						
B-PARTS Z12	S173912(Std)	S173922(Puller)	S173932(Cup)								
XITAN REVOLUTION XTREME	T188371	T188352	T188513	T188514	T188515				T188590(9.5m)		
XITAN Z9	P173611	P173612	P173613	P173614	P173615	P173616	P173617	P173618	P173690(13m)		
XITAN Z8			T188313	T188314	T188315	T188316	T188317		T188390(13m)		
XITAN Z6			T188213	T188214	T188215	T188216	T188217		T188290(13m)		
Z ULTRA POWER			T188113	T188114	T188115	T188116	T188117		T188190(13m)		
Z ALLROUNDER			T188013	T188014	T188015	T188016	T188017		T188090(13m)		
A-PARTS XITAN POWER	T188321(3.9mm)	T188331(4.5mm)	T188341	T188351(3.9mm)	T188361(4.5mm)	T188371(5.5MM)					
B-PARTS XITAN POWER	T188322(3.9+4.5mm)	T188332(L Cup)	T188352(3+4+5mm)								
CARBOXY GOLD II	R162211	R162212	R162213	R162214	R162215	R162216	R162217	R162218	R162290(13m)		
SNIPER PRO CARP	R163011	R163012	R163013	R163014	R163015	R163016	R163017	R163018	R163090(11m)		
SNIPER CARP	R164011	R164012	R164013	R164014	R164015	R164016	R164017	R164018	R164090(11m)		
BLACK MAGIC SLIMSTAR	T189011	T189012	T189013	T189014	T189015	T189016	T189017		T189090(11m)		
BLACK MAGIC FORCE PRO CANAL	T180611	T180612	T180613	T180614	T180615	T180616			T180690(8m)	T180691(9.5m)	
TRAILBLAZER STRONG	S113311	S113312	S113313	S113314	S113315	S113316	S113317	S113318	S113390(11m)		
MERIDA	S105311	S105312	S105313	S105314	S105315	S105316	S105317		S105390(9.5m)		
POWER KIT MERIDA	S105301	S105302									
DRAG' N NET II	S120911	S120912	S120913	S120914					S120990(5.5m)		
MARGIN MAULER	N187311	N187312	N187313						N187390(4m)		
MARGIN MAULER II	S187211	S187212	S187213						S187290(5m)		
PIT BULL	S187111	S187112	S187113	S187124	S187125				S187190(4m)	S187191(6m)	
ACTIVATE	Q113111	Q113112	Q113113	Q113114	Q113115	Q113116			Q113190(9.5m)	Q113191(11m)	
BIG FISH 4/6/8	S140811	S140812	S140813	S140814	S140815	S140816			S140890(4m)	S140891(6m)	S140892(8m)
AMBITION THUNDER	S128711	S128712	S128713	S128714	S128715	S128716			S128790(6m)	S128791(7m)	
AMBITION X-CITE	S129811	S129812	S129813	S129814	S129815	S129816			S129890(7m)	S129891(8m)	
BLACK MAGIC TELE	T156911	T156912	T156913	T156914	T156915	T156916	T156917	T156918	T156993(8m)	T156994(9m)	T156995(10m)
MERIDA POWER TELE	T153711	T153712	T153713	T153714	T153715	T153716	T153717		T153791(4.8m)	T153792(5.8m)	T153793(6.8m)
AMBITION TELE	S170911	S170912	S170913	S170914	S170915	S170916			S170990(5m)	S170991(6m)	S170992(7m)
MERIDA TELE	S153011	S153012	S153013	S153014	S153015	S153016			S153090(4m)	S153091(5m)	S153092(6m)

PREVIOUS POPULAR MODELS	A/1	B/2	C/3	D/4	E/5	F/6	G/7	H/8	I/9 / Butt	J/10 / Butt	Butt
XITAN Z7	N173311	N173312	N173313	N173314	N173515	N173516	N173517	N173518	N173590(13m)		
XITAN Z4.5	N173311	N173312	N173313	R173714	R173715	R173716	R173717	R173718	R173790(13m)		
XITAN Z7.5	N173311	N173312	N173313	R173814	R173815	R173816	R173817	R173818	R173890(13m)		
XITAN Z4	N173311	N173312	N173313	N173314	N173415	N173416	N173417	N173418	N173490(13m)		
XITAN Z3	N173311	N173312	N173313	N173314	N173315	N173316	N173317	N173318	N173390(13m)		
XITAN Z2 CARP MASTER	N173311	N173312	N173313	R173214	R173215	R173216	R173217	R173218	R173290(13m)		
XITAN Z1	N173311	N173312	N173313	N173314	P173115	P173116	P173117	P173118	P173190(13m)		
TENSION PULLER KIT L	N173301	N173302									
POWER KIT Z1 Z3/Z4	N173310	N173320									
CARBOXY GOLD	M162111	M162112	M162113	M162114	M162115	M162116	M162117	M162118	M162190(12.5m)		
POWER KIT CARBOXY GOLD	M162110	M162120									
BLACK MAGIC FORCE	M102811	M102812	M102813	M102814	M102815	M102816	M102817	M102818	M102890(11m)		
POWER KIT BLACK MAGIC FORCE	M102810	M102820									
MINI EXT BLACK MAGIC FORCE	M102899										
BLACK MAGIC UNLIMITED	L102911	L102912	L102913	L102914	L102915	L102916	L102917		L102990(11m)		
BLACK MAGIC III	H103311	H103312	H103313	H103314	H103315	H103316	H103317	H103318	H103390(11m)		
CC1000 CSPEC	L186811	L186812	L186813	L186814	L186815	L186816	L186817	L186818	L186890(13m)		
BERYLLIUM MSPEC	L162011	L162012	L162013	L162014	L162015	L162016	L162017	L162018	L162090(11.5m)	L162091(13m)	
BERYLLIUM CSPEC	L161911	L161912	L161913	L161914	L161915	L161916	L161917		L161990(11.5m)	L161991(13m)	
POWER KIT C/MSPEC	L161910	L161920									
XITAN CARP POWER	P162811	P162812	P162813	P162814	P162815	P162816	P162817		P162890(11m)		
POWER KIT XITAN CARP POWER	P162810	P162820									
THALLIUM FORCE	P163911	P163912	P163913	P163914	P163915	P163916			P163990(9.5m)	P163991(11m)	
FORCE PRO CANAL	R134811	R134812	R134813	R134814	R134815	R134816			R134890(8m)	R134891(9.5m)	
POWER KIT FORCE PRO CANAL	S134801	S134802									
FIRST PREMIUM	Q135211	Q135212	Q135213	Q135214	Q135215	Q135216	Q135217		Q135290(9.5m)		

HYBRID

BETTER THAN AVERAGE TACKLE FOR BETTER THAN AVERAGE FISH!

Hybrid Rods – Specimen rods for match anglers and match rods for specimen anglers!

The Hybrid range of rods have been designed with progressive but powerful “all-through” actions suitable for hard fighting fish. The rods have an eye-catching design, which is both practicable and makes them stand out from other rods.



3 FEEDER TIPS

Hybrid Method Feeder

An outstanding rod for fishing with method feeders. Our testers were particularly impressed with the casting precision of this three-piece rod. While earlier specialist rods for the Method were somewhat heavily actioned and tailored towards carp and tench, today more sensitive rods are called for that can also register subtle bites – criteria ably fulfilled by the Hybrid Method Feeder. The rod is supplied with 1.5, 2.0 and 3oz glass quiver tips to suit different conditions.

Code	Model	Length	Sections	Testcurve	Tr.-Length	Weight
1286 360	Method Feeder	12'/3.60 m	3+3	1.5 lbs	1.26 m	266 g



3 FEEDER TIPS

Hybrid Distance Method Feeder

When it comes to punching out method feeders that bit further, the Hybrid Distance Method Feeder is in its element. This rod can cast long distances but still has an action and tip sensitivity perfect for bite indication. Playing big and aggressive fish is a sheer joy on this rod due to the through action that absorbs even the most ferocious runs of carp and big bream. The rod is supplied with 1.5, 2.0 and 3oz glass quiver tips to suit different conditions.

Code	Model	Length	Sections	Testcurve	Tr.-Length	Weight
1286 390	Dist. Meth. Feed.13'	13'/3.90 m	3+3	1.5 lbs	1.38 m	308 g

All rods



3 FEEDER TIPS

Hybrid Avon Dual Tip

Classic, multi-purpose, “Avon” rod supplied with 2 different top sections. The high-modulus carbon blank is beautifully light and slim and has a progressive “all through” action perfect for catching quality fish like Tench, Chub, Bream plus medium sized Carp and Barbel. Top 1 makes the rod a conventional 1.75lb testcurve Avon rod for fishing with floats or bite indicators. Top 2 maintains the rod’s perfect action but converts it into a quiver tip rod for feeder work or general ledgering. The rod is supplied with 2, 3 and 4oz glass quiver tips to suit different conditions. This one rod will do just about everything that’s asked of it!

Code	Model	Length	Sections	Testcurve	Tr.-Length	Weight
1596 360	Avon Dual Tip	12'/3.60 m	2+1/3	1.75 lb	1.28 m	275 g



3 FEEDER TIPS

Hybrid Barbel

A classic through-actioned Barbel rod, but also suitable for all big fish. The rod has been designed in 3 pieces to eliminate the difficulties in transporting long-sectioned 2 piece rods. Supplied with a 2 oz glass tip plus 4 & 6oz carbon tips.

Code	Model	Length	Sections	C.W.	Tr.-Length	Weight
1283 360	Hybrid Barbel	12'/3.60 m	3+3	5-10 lbs/50 g	1.28 m	271 g

HYBRID

BETTER THAN AVERAGE TACKLE FOR
BETTER THAN AVERAGE FISH!

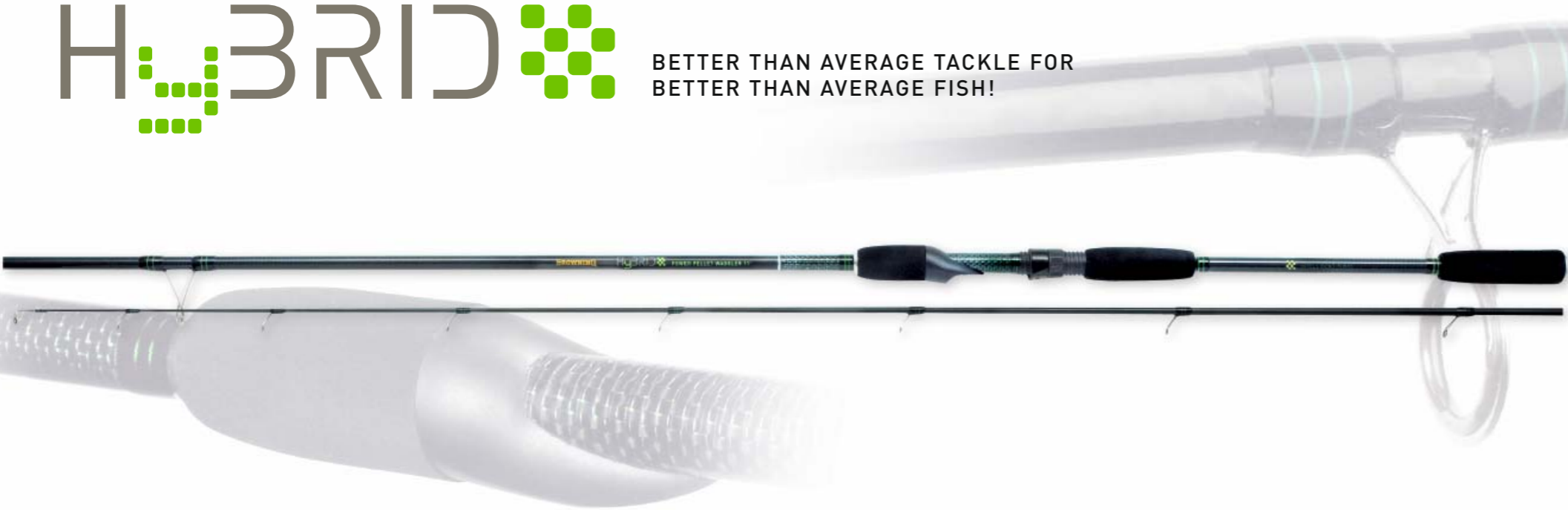

All rods



All hybrid rods are supplied in a matching carry bag.



3 FEEDER TIPS



Hybrid Power Pellet Waggle

Takes up when normal pellet waggler rods feel under-gunned. Has enough "action" to cast light floats but is around 20% more powerful than conventional pellet waggler rods. Never feel under-gunned again – a real "bagging" tool.

Code	Model	Length	Sections	C.W.	Tr.-Length	Weight
1280 330	Power Pellet	11' / 3.30 m	2	4-10 lbs/40 g	1.70 m	188 g

Hybrid Power Waggle

A longer, 3 piece, version of the Pellet Waggle for fishing at longer range. Perfect for big "splasher" floats and the bagging waggler. The rod is also ideal for river fishing for chub and barbel with big floats and is an ideal all-round float fishing rod for most anglers.

Code	Model	Length	Sections	C.W.	Tr.-Length	Weight
1281 385	Power Waggle	12'6" / 3.85 m	3	4-10 lbs/40 g	1.34 m	274 g

Hybrid Power Feeder

The action of 11' 2 piece rod is around 20% more powerful than typical feeder rods, yet it retains a very progressive all-through action which minimises hook pulls at close range. Power and finesse in one rod. Supplied with 1, 2 & 3 oz glass tips.

The 12' is a powerful but progressive actioned feeder rod that will cast big feeders and land big fish with ease. Perfect for catching big fish with big feeders from big rivers or big lakes. Supplied with 2 & 3 oz glass tips plus a 4oz carbon tip for river fishing.

Code	Model	Length	Sections	C.W.	Tr.-Length	Weight
1282 330	Power Feeder S	11' / 3.30 m	2+3	4-10 lbs/60 g	1.70 m	288 g
1282 360	Power Feeder L	12' / 3.60 m	3+3	4-10 lbs/80 g	1.27 m	268 g



All rods



Black Magic Bolo

Bolognese rods can be an extremely efficient catching tool and their effectiveness is still underestimated in the UK. Browning has extensive experience in Bolo rods and also applies its expert knowledge of top quality poles when designing these telescopic rods. The new Black Magic Bolo is super-light with a fast and crisp action. The rod is set off by a high quality finish throughout – from the reel holder to the whippings - and the sliding guides of the top two sections with carbon sleeves.

Code	Model	Length	Sections	C.W.	Tr.-Length	Weight
1057 600	Black Magic Bolo 600	6.00 m	6	25 g	1.42 m	250 g
1057 700	Black Magic Bolo 700	7.00 m	7	25 g	1.42 m	326 g
1057 800	Black Magic Bolo 800	8.00 m	8	25 g	1.42 m	410 g

Xitan Neo

A Bolognese rod with a powerful action and yet ultra light. Equipped with SIC rings and finished in the latest high modulus carbon fibre. All guide whippings are sealed with epoxy resin.

Code	Model	Length	Sections	C.W.	Tr.-Length	Weight
1058 600	Xitan Neo 600	6.00 m	6	30 g	1.42 m	220 g
1058 700	Xitan Neo 700	7.00 m	7	30 g	1.42 m	292 g
1058 800	Xitan Neo 800	8.00 m	8	30 g	1.42 m	360 g

Ambition Pro Bolo

Perhaps the hardest balancing act: The entry-level Bolognese rod must not be too expensive, so high-modulus carbon must be used sparingly yet without the rod becoming too flimsy or even bulky. The Ambition Pro Bolo provides an excellent compromise, representing possibly the best Bolo in this price segment ever made.

Code	Model	Length	Sections	C.W.	Tr.-Length	Weight
1340 500	Ambition Pro Bolo	5.00 m	5	6-12 g	1.47 m	280 g
1340 600	Ambition Pro Bolo	6.00 m	6	6-12 g	1.50 m	336 g
1340 700	Ambition Pro Bolo	7.00 m	7	6-12 g	1.42 m	430 g
1340 800	Ambition Pro Bolo	8.00 m	8	6-12 g	1.47 m	610 g

Simon Achhammer (D)



Practical to store and quick to set up. Telescopic coarse rods have firmly established themselves and, thanks to modern construction, are much better than their reputation suggests in comparison to conventional rods.



FULL CORK HANDLE



All rods



CARBON WRAP REINFORCEMENT



Force Tele Match

Fans of telescopic rods are certain to welcome the Force Tele Match. Despite being a telescopic rod, the Force Tele Match has a fantastic action and enough guides to guarantee perfect line run. It also demonstrates perfect balance in the hand.

Code	Model	Length	Sections	C.W.	Tr.-Length	Weight
1911 390	Force Tele Match	3.90 m	7	2-25 g	1.08 m	220 g
1911 420	Force Tele Match	4.20 m	7	2-25 g	1.08 m	240 g
1911 450	Force Tele Match	4.50 m	7	4-30 g	1.08 m	265 g

Ambition Tele Feeder MH

A sensation in the rod market: A telescopic feeder rod! Extremely easy to transport and yet with astonishing performance. More than just a quick fix solution for the occasional angler. To change the tip the end ring must be removed (hot melt adhesive); spare top ring and push over rings are supplied with the second feeder tip.

Code	Model	Length	Sections	C.W.	Tr.-Length	Weight
1717 360	Ambition Tele Feeder MH	3.60 m	5	120 g	1.25 m	242 g

Ambition Tele Strong

Fans of telescopic rods are certain to welcome the Ambition Tele Strong. Despite being a telescopic rod, the Ambition Tele Strong has a fantastic action and enough guides to guarantee perfect line run. It also demonstrates perfect balance in the hand.

Code	Model	Length	Sections	C.W.	Tr.-Length	Weight
1710 420	Ambition Tele Strong II	4.20 m	5	30 g	1.38 m	305 g
1710 450	Ambition Tele Strong II	4.50 m	5	60 g	1.42 m	351 g
1711 360	Ambition Tele Strong H II	3.60 m	5	70 g	1.15 m	210 g
1711 400	Ambition Tele Strong H II	4.00 m	5	70 g	1.15 m	260 g
1711 450	Ambition Tele Strong H II	4.50 m	5	70 g	1.17 m	303 g

Ambition Tele Float II

Popular range of telescopic coarse rods in three lengths. When the float finally dips, the pleasantly balanced action and fast reacting tip make striking child's play. And all at an unprecedented price performance ratio.

Code	Model	Length	Sections	C.W.	Tr.-Length	Weight
1712 360	Ambition Tele Float II	3.60 m	6	2-20 g	0.80 m	285 g
1712 390	Ambition Tele Float II	3.90 m	7	5-25 g	0.80 m	315 g
1712 420	Ambition Tele Float II	4.20 m	7	5-25 g	0.85 m	404 g





All rods



New: now also in 4.20 m and 4.50 m lengths

Champion's Choice 13' Super Match

"The best rods Browning have ever made" – a bold statement made by Bob Nudd but true! As with the Champion's Choice Superfeeder rods on page B45, we have applied lessons learned on optimising carbon construction when making our Xitan poles to this new rod. The Super Match is a multi-purpose rod capable of a wide range of float fishing styles. Rivers, lakes, small floats, big floats – the Super Match will do it. As you would expect, the rod is slim and very light so can be held and used for hours without fatigue. The blank is crisp and will pick up line immediately on the strike improving bite-to-fish ratios. However, the fine tip allows light lines to be used with confidence. The rod looks as good as it fishes with top-quality fittings and comfortable Fuji reel seat which make the rod a joy to use and own. For those who want the best. Available in a fast but forgiving superlight action for fine lines.

Code	Model	Length	Sections	C.W.	Tr.-Length	Weight
1594 390	CC Super Light	13'/3.90 m	3	15 g	1.38 m	180 g
1594 391	CC Super Match	13'/3.90 m	3	30 g	1.38 m	184 g
1594 420	CC Super Match	14'/4.20 m	3	25 g	1.46 m	213 g
1594 450	CC Super Match	15'/4.50 m	3	35 g	1.58 m	271 g



Force Silver Match

New, beautifully light actioned float rods designed for mixed fishing. Perfect for wagglers to 8gr and hooklengths down to 0.07mm. This slim and very light rod has a faultless progressive action, which allows even bigger fish to be landed on light lines. The perfect allrounder for light tackle fishing on rivers and lakes.

Code	Model	Length	Sections	Line	Tr.-Length	Weight
1816 390	Force Silver Match	13'/3.90 m	3	15 g	1.35 m	209 g



Force Match

Slightly more powerful versions of the Force Silver Match designed for longer casts with bigger wagglers up to 16gr. Same faultless action, light weight, and quality fittings. Also a good choice for anglers that predominantly fish for bigger species like carp, bream and barbel.

Code	Model	Length	Sections	C.W.	Tr.-Length	Weight
1817 390	Force Match	13'/3.90 m	3	25 g	1.35 m	225 g
1817 420	Force Match	14'/4.20 m	3	25 g	1.45 m	237 g



Force Float

The power rod of the new Force range. Capable of long casts with big wagglers yet careful design has allowed us to retain the progressive and forgiving action needed when playing and landing fish at closer range. Also a good choice for catching powerful fish from powerful rivers.

Code	Model	Length	Sections	C.W.	Tr.-Length	Weight
1819 330	Force Float	11'/3.30 m	3	10-40 g	1.15 m	210 g
1819 360	Force Float	12'/3.60 m	3	10-40 g	1.25 m	227 g
1819 390	Force Float	13'/3.90 m	3	10-40 g	1.35 m	248 g
1819 420	Force Float	14'/4.20 m	3	10-40 g	1.45 m	276 g



COMMERCIAL KING

In 2010 Browning were amongst the very first to offer new styles of short rod which challenged the need for traditional length rods on commercial fisheries. Our Force 8' Wand and 9' Micro Wagglers were big sellers and soon copied. For 2013 we have refined our designs further to stay „ahead of the game“. The result is our new range of seven Commercial King rods.

These new rods are based around ultra slim and light high modulus full carbon blanks. We have carefully considered every aspect of the rod, not just the action. They are absolutely perfect and look superb! These rods are typically HALF the cost of similar quality rods from other suppliers. We challenge anybody to find an equal performing rod at these prices.

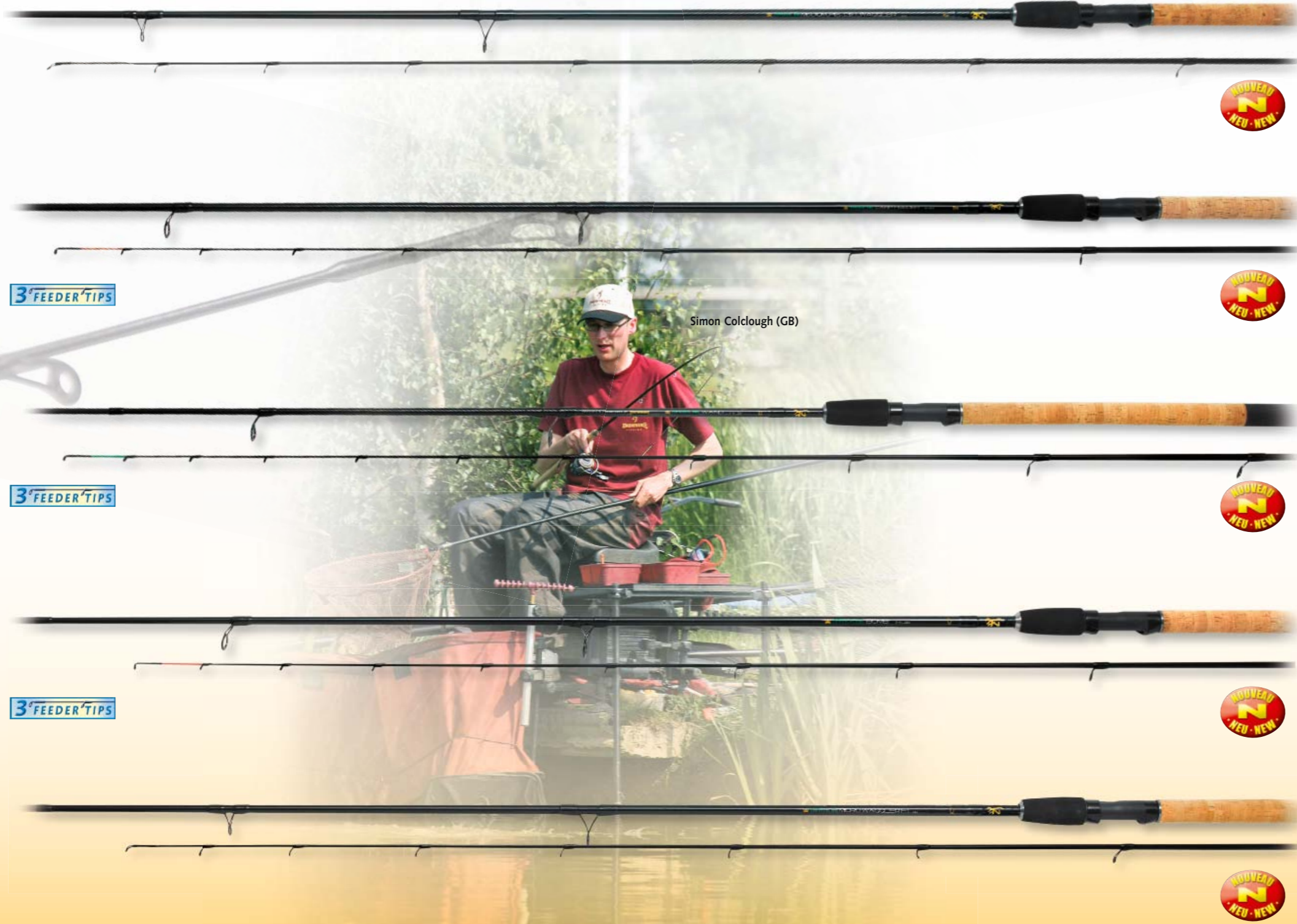

Simon Colclough (GB)

Commercial King Pellet Wagglers

2 piece, 11' rods with perfect, parabolic, „non-lock“ actions. Shorter than normal handles allow the rods to be moved around quickly for „feed-cast-feed“ techniques. The medium rod has a standard action for wagglers to 12gr. The Power version is around 15% stiffer for situations involving bigger floats, bigger fish or bigger weights!

Code	Model	Length	Sections	C.W.	Tr.-Length	Weight
1268 330	Medium Pellet Wagglers	11'/3.30 m	2	20 g	1.69 m	155 g
1268 331	Power Pellet Wagglers	11'/3.30 m	2	30 g	1.69 m	161 g

Commercial King Carp Feeder

Classic through actioned rod for fishing at medium range. The 2 piece rod has power in the butt section for casting and landing fish quickly, but retains a softer action in the middle essential to eliminate hook-pulls when playing hard fighting carp at close range. Suitable for feeders to around 40gr, hooklengths to 0.22mm and is supplied with 3 glass tips (0,5 oz, 1 oz, 1,5 oz).

Code	Model	Length	Sections	C.W.	Tr.-Length	Weight
1294 330	Carp Feeder	11'/3.30 m	2+3	20-60 g	1.70 m	218 g

Commercial King Wand

Try one of these and you will never use a long rod again! The ultimate rods for close range tip fishing. The 8' length dramatically improves accuracy and lands fish incredibly quickly. Forgiving through actions but power in the butt so can be a real „bagging“ rod. The F1 version is around 20% softer and is perfect for winter carp fishing with light lines and small hooks. Both supplied with 3 glass tips (0,5 oz, 1 oz, 1,5 oz).

Code	Model	Length	Sections	C.W.	Tr.-Length	Weight
1805 245	Wand	8'/2.45 m	2+3	3-8 lbs	1.27 m	144 g
1805 246	Wand F1	8'/2.45 m	2+3	2-4 lbs	1.27 m	150 g

Commercial King Bomb

The classic 10', 2 piece „bomb“ rod. A rod that can be used for just about anything – feeder, bomb, method, winter scratching or big summer catches. Powerful enough for carp but forgiving enough for skimmers, light lines and small hooks. Short handle length for ease of use. Supplied with 3 glass tips (0,5 oz, 1 oz, 1,5 oz).

Code	Model	Length	Sections	C.W.	Tr.-Length	Weight
1808 300	Bomb	10'/3.00 m	2+3	3-6 lbs	1.55 m	188 g

Commercial King Micro Wagglers

Long rods – who needs them? The new „must have“ for commercial anglers: Short handles and feather light weight make these short rods unbelievably fast and accurate to fish with. They are simply unbeatable for short to medium distances. The 9' rod is deceptively powerful and tames even big fish very quickly. The 10' F1 version is around 20% softer and perfect for smaller floats, lighter lines and smaller hooks. These rods are natural partners for our Wand tip rods.

Code	Model	Length	Sections	C.W.	Tr.-Length	Weight
1810 270	Micro Wagglers	9'/2.70 m	2	20 g	1.40 m	143 g
1810 300	Micro Wagglers F1	10'/3.00 m	2	10 g	1.55 m	154 g



All rods



Hot Rod Multi Float

A real flexible friend ! This attractive range of multi-purpose float rods are firmly aimed at general coarse fishing. They are truly "multi-purpose" rods due to actions that are slightly more powerful than the typical match rod. A one-rod answer to float fishing river or lake for quality roach, bream, tench or even carp.

Code	Model	Length	Sections	C.W.	Tr.-Length	Weight
1273 330	Hot Rod Multi Float	11'/3.30 m	3	8-25 g/2-6 lb	1.08 m	190 g
1273 360	Hot Rod Multi Float	12'/3.60 m	3	8-25 g/2-6 lb	1.18 m	215 g
1273 390	Hot Rod Multi Float	13'/3.90 m	3	8-25 g/2-6 lb	1.36 m	228 g



Ambition Match

Classic look, fantastic performance and unbeatable price. Browning match rods have never been more affordable. The fine action has been combined with the smart burgundy design and gold silver connections. With comfort grip and EVA handle.

Code	Model	Length	Sections	C.W.	Tr.-Length	Weight
1714 390	Ambition Match L	13'/3.90 m	3	6-12 g	1.37 m	220 g
1714 420	Ambition Match M	14'/4.20 m	3	12-20 g	1.49 m	277 g



Ambition X-Cite Match II

When money is tight but you want the best quality possible, you can trust that Browning will always offer you excellent value for money. This cosmetically appealing match rod is available in three different lengths to cater for all personal preferences.

Code	Model	Length	Sections	C.W.	Tr.-Length	Weight
1706 360	Ambition X-Cite Match II	3.60 m	3	20 g	1.25 m	263 g
1706 390	Ambition X-Cite Match II	3.90 m	3	20 g	1.35 m	290 g
1706 420	Ambition X-Cite Match II	4.20 m	3	20 g	1.45 m	319 g



Ambition X-Cite Float II

The equivalent to the X-Cite Match rod range, but also available for the feeder fans. Designed for taming larger bream, tench and the occasional carp.

Code	Model	Length	Sections	C.W.	Tr.-Length	Weight
1708 300	Ambition X-Cite Float II	10'/3.00 m	3	30 g	1.04 m	196 g
1708 360	Ambition X-Cite Float II	12'/3.60 m	3	30 g	1.27 m	247 g

Available from february 2013!



All rods

Spare Tips

Ultra-sensitive, perfectly finished spare quivertips for the Black Viper series of rods.

Code	Model	Length	Test Curve	Ø
1813 001	Black Viper Spare Tip	60 cm	0.50 oz	3.5 mm
1813 002	Black Viper Spare Tip	60 cm	0.75 oz	3.5 mm
1813 003	Black Viper Spare Tip	60 cm	1.00 oz	3.5 mm
1813 004	Black Viper Spare Tip	60 cm	1.50 oz	3.5 mm
1813 005	Black Viper Spare Tip	70 cm	1.00 oz	3.5 mm
1813 006	Black Viper Spare Tip	70 cm	1.50 oz	3.5 mm
1813 007	Black Viper Spare Tip	70 cm	2.00 oz	3.5 mm
1813 008	Black Viper Spare Tip	70 cm	3.00 oz	3.5 mm
1813 009	Black Viper Spare Tip	70 cm	4.00 oz	3.5 mm
1813 010	Black Viper Spare Tip	70 cm	5.00 oz	3.5 mm
1813 011	Black Viper Spare Tip	70 cm	6.00 oz	3.5 mm
1813 012	Black Viper Spare Tip	70 cm	7.00 oz	3.5 mm



Black Viper MK11

The ultra-fast action of the MK11 provides above average casting power for an 11' / 3.3-metre rod. Distances to 50 m are easily achieved with large feeders, and with accuracy that only shorter rods achieve. Perfect for mid-distance fishing with large method or open-end feeders or for bomb fishing for larger than average fish.

Code	Model	Length	Sections	C.W.	Tr.-Length	Weight
1813 330	Black Viper MK11	11'/3.30 m	2+3	50g	1.68 m	187 g

Black Viper MK12

Perfect for anglers needing a slightly "stepped-up" feeder rod, this deceptively powerful 12' / 3.6m rod is designed for fishing medium feeders at ranges to around 60m on lakes, rivers or the big continental canals. The slim high-modulus blank has power in the middle and lower sections allowing feeders to be "punched" out with high accuracy. However it retains a forgiving top section for playing fish at close range. Slim, light and good looking with top quality fittings.

Code	Model	Length	Sections	C.W.	Tr.-Length	Weight
1813 360	Black Viper MK12	12'/3.60 m	3+3	80 g	1.25 m	233 g

Black Viper MK13

We offer two different versions of the 13' Black Viper rod. The standard MK13 has an average action typical of 13' rods and is perfectly suited to slow-flowing rivers and lakes with typical casting ranges of 30 to 80. The mellow action allows light hook-lengths to be used with confidence.

The Black Viper MK13 "S" is a fast actioned, more specialist, version which provides the power for casts up to around 100m without sacrificing its fish playing action. The dynamic design of the blank does all the work on the cast - meaning less effort is required from the angler. Long casts can be achieved even by anglers less experienced at long distance casting. Both rods are balanced for their length and feel as good as they look. Top quality fittings throughout.

Code	Model	Length	Sections	C.W.	Tr.-Length	Weight
1813 390	Black Viper MK13	13'/3.90 m	3+3	100 g	1.35 m	277 g
1813 391	Black Viper MK13 S	13'/3.90 m	3+3	140 g	1.35 m	295 g

Black Viper MK14

Like the Black Viper MK13, the 14' version is also available in two types. The standard Black Viper MK14 is the ultimate casting tool. Far, further furthest - you will never be out-distanced ! The high-modulus blank is powerful and designed for comfortable casting to distances of 70 to 120 m. Our dynamic blank designs throughout the range eliminate the need for violent, aggressive casts. Accurate casting to over 100m is both realistic and easily achievable with these rods. The Black Viper MK14 "S" version is the ultimate powerhouse, with the same attributes as the standard MK14 rod, but with even more power for when big heavily loaded feeders are needed.

Code	Model	Length	Sections	C.W.	Tr.-Length	Weight
1813 420	Black Viper MK14	14'/4.20 m	3+3	120 g	1.46 m	315 g
1813 421	Black Viper MK14 S	14'/4.20 m	3+3	160 g	1.46 m	340 g

Black Viper MK15

For extreme feeder situations, the Black Viper MK15 comes into its own: Despite its light weight and astoundingly slim blank, this rod has so much power that no feeder is too heavy! Feeders of over 250 g are handled with ease. This makes the Black Viper MK15 ideal for large continental rivers such as the Danube, Rhine and Main.

Code	Model	Length	Sections	C.W.	Tr.-Length	Weight
1813 450	Black Viper MK15	15'/4.50 m	3+3	250 g	1.56 m	394 g



3 FEEDER TIPS

New: now also in 3.9 m length



All rods



3 FEEDER TIPS



D-Flex Feeder Tips

The sensational feedertips from Browning – made of a carbon reinforced material combination. The benefits: The tips are virtually indestructible and provide feeder rods with improved casting dynamics.

Code	Model	Colour	Test Curve	Ø
1055 001	Feeder Tip	white	1/2 oz	3.50 mm
1055 002	Feeder Tip	white/red	3/4 oz	3.25 mm
1055 003	Feeder Tip	red	1.00 oz	3.25 mm
1055 004	Feeder Tip	green	2.00 oz	3.25 mm
1055 005	Feeder Tip	yellow	3.00 oz	3.25 mm
1055 999	Feeder Tip-Set, 40 Pieces			
Loose Tips Trade pack = 5 Pieces; Set = 1 Piece				



Champion's Choice Superfeeder

"The best rods Browning have ever made" – a bold statement made by Bob Nudd but true! Lessons learned on optimising carbon construction during the making of our Xitan poles have been applied to these totally new Superfeeder rods. The result is a very crisp blank capable of long casts without the side-flex that can affect casting accuracy. However, the rods are also superbly responsive and retain the "feel" essential when playing fish like bream on light hooklengths. The rods feature top quality fittings, a slim Fuji reel seat and slightly oversized top guides to allow shockleaders to pass through cleanly. There are three rods in the range, two of them 12' but with different actions and casting weights plus one in 13'.

The Stillwater has the classic action for medium distance fishing on stillwaters or slower rivers. The soft middle section is equally perfect for soft-mouthed bream or hard fighting carp. The forgiving action is also perfect for fishing with braid. Supplied with 1, 1.5 & 2oz glass tips.

The Medium rod has more power in the middle section and can be "loaded" when casting for long distances with bigger feeders, but still retains a mellow action when playing fish. The Medium is ideal for feeder fishing on faster rivers. The rods are supplied with 1.5, 2, 2.5oz tips.

Code	Model	Length	Sections	C.W.	Tr.-Length	Weight
1593 361	Super Feeder Stillwater	12'/3.60 m	3+3	80 g	1.26 m	178 g
1593 360	Super Feeder Medium	12'/3.60 m	3+3	100 g	1.26 m	193 g
1593 390	Super Feeder Medium	13'/3.90 m	3+3	100 g	1.36 m	220 g
Tip Super Feeder/Bomb				0.75 oz		
Tip Super Feeder/Bomb				1.00 oz		
Tip Super Feeder/Bomb				1.50 oz		
Tip Super Feeder/Bomb				2.00 oz		
Tip Super Feeder/Bomb				2.50 oz		

Champion's Choice 10' Superbomb

A totally new design of Bomb/Short Feeder rod incorporating the very latest developments in carbon technology. Slim, ultra light and with an action optimised for fishing at ranges up to 30m. The soft action is deceptive as this rod is purpose designed to handle "angry" and big carp at close range without hook-pulls, breakages or loss of control. The ideal rod for modern styles of method/in-line feeder fishing and forgiving enough for winter carp fishing with light lines and small hooks. 2 piece for easy carrying and supplied with 0.75, 1 and 1.5 oz tough glass tips for sensitivity and to take the pressure of these demanding carp fishing styles.

Code	Model	Length	Sections	C.W.	Tr.-Length	Weight
1595 300	Super Bomb 10'	10'/3.00 m	2+3	50 g	1.55 m	140 g

Standard Feeder Tips

A selection of the most common replacement feeder tips. As an assortment or separate in packs of 10 per size.

Code	Model	Colour	Test Curve	Ø
1981 001	Feeder Tip	orange	1.00 oz	4.0 mm
1981 002	Feeder Tip	white	1.50 oz	4.0 mm
1981 003	Feeder Tip	green	1.75 oz	4.0 mm
1981 004	Feeder Tip luminous	yellow/lum.	2.00 oz	4.0 mm
1981 005	Feeder Tip luminous	red/lum.	1.50 oz	4.0 mm
1981 999	Feeder Tip-Set, 40 Pieces			
Loose Tips Trade pack = 5 Pieces; Set = 1 Piece				



All rods



Pro Cast Force Feeder

A superb range of feeder rods under the Syntec brand, available in the lengths 12' to 14' (3.60 to 4.20 m). We have spent much time and effort developing this range of exceptional feeder rods. The introduction of this range underlines Browning's expertise in feeder rod design.

Code	Model	Length	Sections	C.W.	Tr.-Length	Weight
1609 360	Pro Cast Force Feeder	12'/3.60 m	3+3	100 g	1.27 m	290g
1609 390	Pro Cast Force Feeder	13'/3.90 m	3+3	120 g	1.37 m	335g
1609 420	Pro Cast Force Feeder	14'/4.20 m	3+3	150 g	1.47 m	375g



Distance Force Feeder

When longer casting distances are the order of the day, the Distance Force Feeder is the more powerful alternative in the Browning Force rod range. The rod has substantial "backbone" and will launch even the heaviest feeders to the horizon !

Code	Model	Length	Sections	C.W.	Tr.-Length	Weight
1608 360	Distance Force Feeder	12'/3.60 m	3+3	140 g	1.28 m	350 g
1608 390	Distance Force Feeder	13'/3.90 m	3+3	160 g	1.38 m	375 g
1608 420	Distance Force Feeder	14'/4.20 m	3+3	250 g	1.48 m	425 g



Black Magic Feeder

Outstanding feeder rods with an excellent price-performance ratio. The slimline, weight-saving SIC rings contribute to an attractive high-quality finish and make the rods particularly responsive. There has never been a better feeder rod in this price range.

Code	Model	Length	Sections	C.W.	Tr.-Length	Weight
1796 360	BM Feeder LM	12'/3.60 m	3+3	60 g	1.27 m	241 g
1796 390	BM Feeder LM	13'/3.90 m	3+3	60 g	1.35 m	270 g
1797 360	BM Feeder M	12'/3.60 m	3+3	80 g	1.26 m	249 g
1797 390	BM Feeder M	13'/3.90 m	3+3	80 g	1.35 m	275 g
1797 420	BM Feeder M	14'/4.20 m	3+3	80 g	1.45 m	344 g
1798 360	BM Feeder MH	12'/3.60 m	3+3	120 g	1.26 m	257 g
1798 390	BM Feeder MH	13'/3.90 m	3+3	120 g	1.35 m	290 g
1798 420	BM Feeder MH	14'/4.20 m	3+3	120 g	1.45 m	348 g





3 FEEDER TIPS

All rods



3 FEEDER TIPS



2 FEEDER TIPS



2 FEEDER TIPS



Hot Rod Feeder 10' & 11'

The 10' version is perfect for short distance fishing on carp fisheries or small rivers. A slightly stiffer action than the typical match-style „bomb“ rods makes it ideal for close range feeder or method fishing. Supplied with 3 tips of 1, 1.5 & 2oz.

The 11' feeder rod was designed with a powerful action for fishing with method feeders with strong lines for bigger fish. Although very powerful, the abbreviated handle design allows the rod to bend throughout its length giving an amazing through action. This rod is also perfect for river fishing for Chub and Barbel. Supplied with 3 tips of 1, 1.5 & 2oz

Code	Model	Length	Sections	C.W.	Tr.-Length	Weight
1274 300	Hot Rod Carp Bomb	10'/3.00 m	3+3	15-40 g/3-8 lb	1.08 m	200 g
1275 330	Hot Rod Carp Feeder	11'/3.30 m	3+3	15-40 g/3-8 lb	1.20 m	222 g

Hot Rod Power Feeder

A real flexible friend ! This attractive range of multi-purpose feeder rods is firmly aimed at general coarse fishing. They are truly "multi-purpose" due to actions that are slightly more powerful than the typical match style feeder rod. A one-rod answer to feeder fishing or legering on river or lake for large roach, bream, tench or even carp.

Code	Model	Length	Sections	C.W.	Tr.-Length	Weight
1276 360	Hot Rod Power Feeder	12'/3.60 m	3+3	40-100 g/3-8 lb	1.28 m	248 g

Ambition Feeder

As with the Ambition Match we have made the purchase of Browning products more affordable than ever before with the feeder rod versions. The angler does not have to make any major compromises on quality, as always this is guaranteed. The blanks of these rods are intelligently designed as the result of years of experience. Equipped with comfort grip and EVA handle.

Code	Model	Length	Sections	C.W.	Tr.-Length	Weight
1716 300	Ambition Feeder L	3.00 m	2+2	60 g	1.57 m	256 g
1716 330	Ambition Feeder M	3.30 m	3+2	90 g	1.16 m	252 g
1716 360	Ambition Feeder MH	3.60 m	3+2	120 g	1.27 m	236 g
1716 390	Ambition Feeder MH	3.90 m	3+2	120 g	1.38 m	304 g
1716 420	Ambition Feeder MH	4.20 m	3+2	140 g	1.47 m	357 g

Ambition Power Feeder II

The more powerful alternative to the Ambition Feeder. River anglers in particular will come to appreciate the high casting weights delivered by the excellent value Ambition range launching extra heavy feeders.

Code	Model	Length	Sections	C.W.	Tr.-Length	Weight
1715 390	Ambition Power Feeder II	3.90 m	3+2	180 g	1.38 m	376 g
1715 420	Ambition Power Feeder II	4.20 m	3+2	180 g	1.47 m	402 g
1764 420	Ambition XXH Powerfeeder	4.20 m	3+2	200 g	1.47 m	425 g

Ambition X-Cite Feeder II

This is what new anglers to feeder fishing have been waiting for. A budget friendly feeder rod range in two lengths. All of Browning's experience in the design of first class feeder rods has been poured into these models.

Code	Model	Length	Sections	C.W.	Tr.-Length	Weight
1707 330	Ambition X-Cite Feeder II	3.30 m	3+2	80 g	1.16 m	270 g
1707 360	Ambition X-Cite Feeder II	3.60 m	3+2	80 g	1.26 m	296 g



As a supplier of premium poles, match and feeder rods we offer a comprehensive range of accessories. Here are some of our most popular items.

Pole Cups

Pole cups are now allowed in matches under CIPS rules making them indispensable in all forms of fishing. Available in a set containing the most common sizes. Marked with mil-litre measures to enable precise measuring of feed. Pole cups are fitted using the supplied adaptors or with the special cupping kits (or power kits).

Code	Size
6789 003	Pole Cup Set (100 ml, 150 ml & 250 ml)
Trade pack - 5 Pieces	



Screw fitting compatible with other popular brands

Elastic Centring Bush

Ensures optimal flow of the elastic through the top kit. Made of foam to adapt to a range of diameters. Fits blanks from 10 mm to 14 mm.

Code	Model
6002 001	Elastic Centring Bush
Trade pack - 10 Pieces	

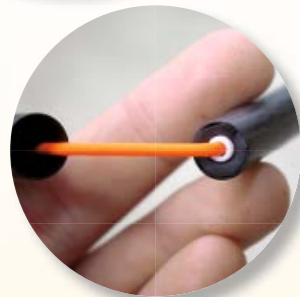

Speed Cupper

Ultra light pole cup in carbon for unbeatable cupping speed. The lip of the cup has been designed to ensure the risk of bait tipping out is minimal.

Code	Model	Weight	Contents
6789 005	Speed Cupper	14 g	250 ml
Trade pack - 5 Pieces			



Xitan Mini-Cups

Simple, functional mini-cups with removable lids and extra-wide fixing slots to suit modern large diameter topkits. 2 sizes in each pack.

Code	Model	Contents
6789 999	Mini Cups	15 ml + 25 ml
Trade pack - 5 Pieces		



Pole Caps

You can simply never have enough of these for sealing poles, top kits and extensions.

Code	Model	Ø
6787 001	Pole Cap	20.5 mm
6787 002	Pole Cap	24.5 mm
6787 003	Pole Cap	27.0 mm
6787 004	Pole Cap	32.0 mm
6787 005	Pole Cap	35.0 mm
6787 006	Pole Cap	38.5 mm
6787 007	Pole Cap	40.0 mm
6787 008	Pole Cap	41.0 mm
6787 009	Pole Cap	42.5 mm
6787 010	Pole Cap	44.0 mm
6787 011	Pole Cap	46.5 mm
Trade pack - 10 Pieces		



Multi Cupper

Innovative cup variant allowing groundbait balls (top) and loose particles or baits (bottom) to be delivered to the swim. The lip of the cup has been designed to ensure the risk of bait tipping out is minimal.

Code	Model	Contents
6789 004	Multi Cupper	250 ml
Trade pack - 5 Pieces		

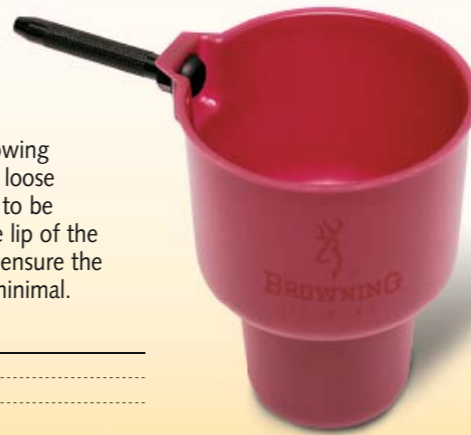

Pole Cones

Useful protection for pole sections. The foam cone helps to center the next section to enable precise assembly. Extends the lifetime of sections considerably when used on all sections. Important: Browning Pole Cones have a drill hole to prevent over pressure or vacuum when mounting and dismounting.

Code	Model	Ø
6785 001	Browning Pole Cones	16.0 mm
6785 002	Browning Pole Cones	18.5 mm
6785 003	Browning Pole Cones	22.0 mm
6785 004	Browning Pole Cones	25.5 mm
6785 005	Browning Pole Cones	27.0 mm
6785 006	Browning Pole Cones	29.0 mm
6785 007	Browning Pole Cones	31.5 mm
6785 008	Browning Pole Cones	33.0 mm
6785 009	Browning Pole Cones	35.0 mm
6785 010	Browning Pole Cones	38.0 mm
Trade pack - 10 Pieces		

Fit modern large diameter poles – up to 24mm joint size



Universal Top Kits

Match anglers can never have enough top sets. That is where our universal top sets come into their own. Two different kit types are available, each in two different diameters. The final section has an extended safety thread, enabling trouble free trimming with a slitting saw to ensure the right fit.

Code	Model	Ø compatible	Length	Sections	Tr.-Length	Weight
1982 001	Cupping Kit	22 - 18 mm	2.95 m	2	1.60 m	130 g
1982 002	Cupping Kit	24 - 20 mm	2.95 m	2	1.60 m	140 g
1982 011	Power Kit 2/1	22 - 18 mm	2.95 m	2	1.60 m	130 g
1982 012	Power Kit 2/1	24 - 20 mm	2.95 m	2	1.60 m	140 g

Hollow Carbon Tips

Supplied in packs of 10 or as a complete range in a wall display unit.

Code	Model	Length	Ø Int.
1680 006	Carbon Tips	80 cm	2.20 - 4.60 mm
1680 007	Carbon Tips	80 cm	2.20 - 4.90 mm
1680 008	Carbon Tips	100 cm	2.40 - 5.30 mm
1680 009	Carbon Tips	110 cm	2.80 - 5.60 mm
Trade pack - 10 Pieces			
1680 005 Carbon Tips-Display (40 pcs.)			



Pole Cleaning Set

Ideal, compact kit containing extendable rods with 3 different size cleaning brushes to thoroughly clean the inside of all sizes of pole sections.

Code	Model	Length
9917 000	Pole Cleaning Set	1.25 m



Feeder Tip Bag

Practical storage bag for spare quivertips. Finished in hard material for optimal protection of delicate tips. With zip fastener.

Code	Model
8518 026	Feeder Tip Bag
Trade pack - 5 Pieces	

HYBRID

BETTER THAN AVERAGE TACKLE FOR BETTER THAN AVERAGE FISH!

Standard features

- 6 ball bearings
- Anodised aluminium spool
- Continuous anti-reverse
- S-curve line distribution
- Robust nylon housing
- Powerful multi-disc front drag system
- CNC metal reel handle
- Deep aluminium spare spool
- Anti-twist line roller
- Foot-Forward® system

Code	Model	m/mm	Gear Ratio	Retrieve	Weight	Ball Bearings
0119 030	Hybrid Com 630 FD	220/0.25	5.2:1	78 cm	260 g	6
0119 040	Hybrid Com 640 FD	250/0.28	4.7:1	81 cm	310 g	6



Hybrid Com FD

A good quality and durable front drag reel with all the advanced features needed when targeting quality fish. The ultra smooth and strong gear set is reliable when the pressure is on – these reels won't let you down. These reels look good with a classy, subdued finish that matches our superb Hybrid rods.



+++EXTRA SPOOLS+++

Code	Size	Model	m/mm
0988 080	630	Match	220/0.25
0988 081	640	Match	250/0.28

Standard features

- 5+1 ball bearings
- Deep aluminium spool
- Continuous anti-reverse
- S-curve line distribution
- Robust nylon housing
- Powerful multi-disc front drag system
- Finely adjustable run control system
- CNC metal reel handle
- Deep aluminium spare spool

Code	Model	m/mm	Gear Ratio	Retrieve	Weight	Ball Bearings
0186 030	Hybrid BF 630	150/0.26	5.0:1	71 cm	330 g	6
0186 040	Hybrid BF 640	150/0.32	5.5:1	75 cm	440 g	6



Hybrid BF

The same quality, features and reliability of our Hybrid Com FD reel, but with a rear drag and the ever popular run control facility. An ultra smooth and strong reel that is a flexible choice for anglers needing a reel to cover all methods and styles of fishing. The small size reel is a light, compact but strong alternative to large run control reels. These reels look good with a classy, subdued finish that matches our superb Hybrid rods.



+++EXTRA SPOOLS+++

Code	Size	Model	m/mm
0988 023	630	deep	150/0.26
0988 024	640	deep	150/0.32



Ultimatch Competition Reel

A compact, top-quality and good looking front drag match reel with a large diameter spool which stops line coiling and bedding-in - a common problem when using the thicker lines that are now common in match fishing. This reel has been purpose designed for modern competition fishing and is packed with features like a one touch folding handle for convenience when carrying rods ready assembled. Perfect for both float and feeder fishing. Performs as well as it looks. The deep spool supplied has TWO line clips for „double clipping“ - for accurate fishing at 2 distances.



Deep spools with 2 line clips.

Standard features

- 6 bearings for super-smooth running and winding power
- Metal body construction
- Shallow over-sized metal spools
- Line friendly clip in a wide recess
- One-touch folding handle
- Non-twist line roller and large diameter bail
- Sensitive multi-disc front drag
- Continuous anti-reverse
- Supplied with spare spool

Code	Model	m/mm	Gear Ratio	Retrieve	Weight	Ball Bearings
0254 035	Ultimatch FD 635	140/0.33	5.0:1	75 cm	312 g	6

+++EXTRA SPOOLS+++

Code	Size	Model
0988 100	635	shallow
0988 101	635	deep





360°-View
On Our Website!
www.zebc-europe.com

Xitan HM

The new 'Holy Grail' reel from Browning with an unprecedented smoothness of gear action and nothing short of an amazing price. During extensive testing our test anglers wanted more and more from the reel, but also demanded that the reel remained at a very competitive price. We will let you be the judge and jury. The high gear ratio of 6.2 : 1 ensures extremely fast line retrieval. Ideal for rapid bait control even when fishing at long distances.



Design features

- shallow aluminium spool
- deep aluminium spare spool
- anti corrosion housing
- computer balanced rotor
- aluminium spool with hardened front edge for longer casting distances
- perfect line distribution
- continuous anti reverse
- high gear ratio providing rapid line retrieval
- finely adjustable rear drag
- 8 high performance ball bearings

Code	Model	m/mm	Gear Ratio	Retrieve	Weight	Ball Bearings
0117 030	Xitan HM 830	150/0.20	6.2:1	101 cm	307 g	8

+++EXTRA SPOOLS+++

Code	Size	Model
0988 063	30	shallow
0988 064	30	deep



360°-View
On Our Website!
www.zebc-europe.com

NOUVEAU
NEU · NEW

Black Magic Burner

The Black Magic® name is synonymous with quality match and feeder reels at reasonable prices. The new Black Magic Burner features high ratio gearing to speed the retrieval rate which is particularly useful to save time and energy, when fishing at longer distances. The reel also features a very smooth gearing and a reliable drag system.



Double Handle included.



Standard features

- Flat long-cast aluminium spool
- Nylon ABS spare spool
- 5 high-performance stainless steel ball bearings and 1 needle bearing
- Continuous anti-reverse
- Gear ratio of 6.1 or 5.5 : 1
- Balanced rotor, producing silky smooth action
- Finely adjustable large-surface front drag
- Compact housing design
- Outstanding line protection line clip.

Code	Model	m/mm	Gear Ratio	Retrieve	Weight	Ball Bearings
0260 020	Black Magic Burner 620	240/0.18	6.2:1	83 cm	260 g	5+1
0260 030	Black Magic Burner 630	200/0.25	6.2:1	91 cm	270 g	5+1
0260 040	Black Magic Burner 640	200/0.30	5.5:1	99 cm	375 g	5+1

+++EXTRA SPOOLS+++

Code	Size	Model	m/mm
0988 102	20	shallow	70/0.18
0988 104	30	shallow	90/0.20
0988 106	40	shallow	110/0.30
0988 103	20	deep	240/0.18
0988 105	30	deep	200/0.25
0988 107	40	deep	200/0.25



Backfire FD

A slick yet functional new edition of the most successful Browning match reel in recent years. Its outstanding feature is the large diameter shallow spool which minimises the irritating and tangle causing coiling which often occurs when using thicker lines on small spools. The large spool also adds to casting distances. A compact and perfect reel for pellet waggler, bomb or small method feeder fishing.



Design features

- 5+1 ball bearings
- Deep aluminium spool with thick spool core
- Continuous anti-reverse
- S-curve line distribution
- Robust nylon housing
- Powerful multi-disc front drag system
- CNC metal reel handle
- Flat aluminium spare spool

Code	Model	m/mm	Gear Ratio	Retrieve	Weight	Ball Bearings
0183 030	Backfire 630 FD	190/0.25	5.1:1	95 cm	357 g	5+1
0183 040	Backfire 640 FD	180/0.30	5.1:1	97 cm	361 g	5+1



Backfire RD

The third member of the Backfire family with the same features and big spool advantages of the other reels in the range, but now with a sensitive rear-drag that some find easier to adjust while playing fish. Available in two sizes to cover a wide range of uses.



Design features

- 5+1 ball bearings
- Deep aluminium spool with thick spool core
- Continuous anti-reverse
- S-curve line distribution
- Robust nylon housing
- Finely adjustable rear drag
- CNC metal reel handle
- Flat aluminium spare spool

Code	Model	m/mm	Gear Ratio	Retrieve	Weight	Ball Bearings
0184 030	Backfire 630 RD	190/0.25	5.1:1	95 cm	356 g	5+1
0184 040	Backfire 640 RD	180/0.30	5.1:1	97 cm	362 g	5+1



Backfire BF

All features of our Backfire FD reel but with the added benefit of a reliable run control system. Fans of run control reels have a choice of two sizes of Backfire, the larger size being perfect for heavy feeder, method and big waggler fishing. The big spool adds meters to casting distances with thick lines.



Design features

- 5+1 ball bearings
- Deep aluminium spool with thick spool core
- Continuous anti-reverse
- S-curve line distribution
- Robust nylon housing
- Powerful multi-disc front drag system
- Finely adjustable run control system
- CNC metal reel handle
- Flat aluminium spare spool

Code	Model	m/mm	Gear Ratio	Retrieve	Weight	Ball Bearings
0182 030	Backfire BF 630	190/0.25	5.1:1	95 cm	426 g	5+1
0182 040	Backfire BF 640	180/0.30	5.1:1	97 cm	430 g	5+1

+++EXTRA SPOOLS+++

Code	Size	Model	m/mm
0988 069	BF 630	shallow	100/0.20
0988 071	BF 640	shallow	140/0.20
0988 073	630 FD	shallow	100/0.20
0988 075	640 FD	shallow	140/0.20
0988 077	630 RD	shallow	100/0.20
0988 079	640 RD	shallow	140/0.20
0988 068	BF 630	deep	190/0.25
0988 070	BF 640	deep	180/0.30
0988 072	630 FD	deep	190/0.25
0988 074	640 FD	deep	180/0.30
0988 076	630 RD	deep	190/0.25
0988 078	640 RD	deep	180/0.30



360°-View
On Our Website!
www.zebco-europe.com

With line roller
ball bearing.

Black Magic®FD Feeder 650 FD

Browning have a lot of expertise in producing specialist tackle purpose designed for the long-distance feeder fishing which is common in mainland Europe. The Black Magic Feeder 650 is an example of a specialist reel packed with features specifically for medium to long-range feeder fishing. Sophisticated wormshaft gears have been used to ensure effortless retrieve and perfect line lay - particularly important for long-distance casting and when using braided lines. This is further enhanced by the large, wide and shallow spool design which can be perfectly filled without resorting to lots of backing. In summary, a purpose designed product that will out-perform conventional reels for this style of fishing.

+++EXTRA SPOOLS+++

Code	Size	Model	m/mm
0988 082	650FD	Match	300/0.16
0988 083	650FD	deep	180/0.30

Design features

- 6+1 ball bearings
- Ultra-flat aluminium spool
- Continuous anti-reverse
- Wormshaft line distribution
- Robust nylon housing
- Powerful multi-disc front drag system
- CNC metal reel handle
- Special feeder line clip to protect the line
- Deep aluminium spare spool

Code	Model	m/mm	Gear Ratio	Retrieve	Weight	Ball Bearings
0242 050	Black Magic Feeder 650 FD	300/0.16	5.5:1	105 cm	431 g	6+1

With line roller
ball bearing.

Black Magic®FD Feeder 665 FD

A monster feeder reel for monster distances! Sharing all the advanced design features and attributes of the Black Magic 650, this 665 sized reel is the ultimate tool for ultra long-distance fishing with powerful rods - no conventional coarse fishing reel will even get close! The Wormshaft gears will withstand the enormous strains of constantly retrieving heavy feeders from long distances. "Hit the horizon" with the Black Magic Feeder 665 FD - the ultimate weapon for the long-range feeder angler.

+++EXTRA SPOOLS+++

Code	Size	Model	m/mm
0988 086	665FD	shallow	400/0.16
0988 087	665FD	deep	270/0.30

360°-View
On Our Website!
www.zebco-europe.com

With line roller
ball bearing.

Black Magic®Feeder 650 BF

Another member of the Black Magic family of over-sized reels, with same specialist design, features and wormshaft gearing as the other two reels in the range, but incorporating a run control facility. An alternative to conventional carp-oriented run control reels. Perfect for long-distance fishing with finer lines or braid for species like bream and tench

+++EXTRA SPOOLS+++

Code	Size	Model	m/mm
0988 084	650BF shallow		300/0.16
0988 085	650BF deep		180/0.30

Design features

- 6+1 ball bearings
- Ultra-flat aluminium spool
- Continuous anti-reverse
- Wormshaft line distribution
- Robust nylon housing
- Powerful multi-disc front drag system
- Finely adjustable run control system
- CNC metal reel handle
- Special feeder line clip to protect the line
- Deep aluminium spare spool

Code	Model	m/mm	Gear Ratio	Retrieve	Weight	Ball Bearings
0241 050	Black Magic Feeder 650 BF	300/0.16	5.5:1	105 cm	476 g	6+1

Design features

- 6+1 ball bearings
- Ultra-flat aluminium spool
- Continuous anti-reverse
- Wormshaft line distribution
- Robust nylon housing
- Powerful multi-disc front drag system
- CNC metal reel handle
- Special feeder line clip to protect the line
- Deep aluminium spare spool

Code	Model	m/mm	Gear Ratio	Retrieve	Weight	Ball Bearings
0240 065	Black Magic Feeder 665 FD	400/0.16	4.5:1	101 cm	712 g	6+1

360°-View
On Our Website!
www.zebco-europe.com

Dual-Distance-Clip-Concept

Force Feeder Extreme

Feeder fishing at 100 meters distance? Unthinkable some years ago, now a standard distance for many pros. However, rather than resorting to a traditional surf reel, they should really take a closer look at the Force Feeder. Never has there been a more uncompromising feeder reel for extreme casting distances. Gear ratio, line capacity, spool design, transmission power – all have been optimised for this precise purpose. Test anglers were immediately impressed.



Design features

- Flat aluminium extreme cast spool
- Spare spool
- 7 high performance stainless steel ball bearings and 1 needle bearing
- 2 Non-twist line rollers and large diameter bail
- Continuous anti reverse
- High speed gear ratio 4.9 : 1
- Balanced rotor, producing silky smooth action
- Finely adjustable front drag
- Wormshaft oscillation system
- Bail Release Protection prevents the bail arm from closing prematurely on the cast

Code	Model	m/mm	Gear Ratio	Retrieve	Weight	Ball Bearings
0175 060	Feeder 860 FD	150/0.30	4.9:1	103 cm	530 g	7+1

+++EXTRA SPOOLS+++

Code	Size	Model
0988 052	60	shallow

Ambition

The perfect partner for our match and feeder rods in the Ambition range. They may be economic but they work seamlessly and they look great, too! We are confident that these reels will break sales records once again. Highly versatile: all four models are accessible to the price-conscious angler in sizes 30 and 40, and with a choice of a front or rear drag.

Design features

- Anti corrosion housing
- Computer balanced rotor
- Aluminium spool with hardened front edge for longer casting distances
- Slim line handle
- Perfect line distribution
- High gear ratio providing rapid line retrieval
- Finely adjustable rear drag (RD) and front drag (FD)
- 3 high performance ball bearings
- Spare spool

Ambition RD

Code	Model	m/mm	Gear Ratio	Retrieve	Weight	Ball Bearings
0180 030	Ambition RD 330	200/0.20	5.1:1	70 cm	312 g	2+1
0180 040	Ambition RD 340	280/0.25	5.1:1	75 cm	407 g	2+1

+++EXTRA SPOOLS+++

Code	Size	Model
0988 037	30	shallow
0988 048	40	deep



Ambition FD

Code	Model	m/mm	Gear Ratio	Retrieve	Weight	Ball Bearings
0181 030	Ambition FD 330	200/0.20	5.1:1	70 cm	296 g	2+1
0181 040	Ambition FD 340	280/0.25	5.1:1	76 cm	381 g	2+1

+++EXTRA SPOOLS+++

Code	Size	Model
0988 040	30	shallow
0988 045	40	deep



HYBRID

BETTER THAN AVERAGE TACKLE FOR BETTER THAN AVERAGE FISH!

Better than average tackle for better than average fish!

In recent years, match angling and specimen angling have been getting closer in techniques and methods. The Browning Hybrid range of tackle has been specially designed to bridge the gap between match and specimen angling. For many anglers and situations "match" style tackle is too weak; but conventional "specimen" tackle is too powerful and spoils the enjoyment of playing mid-sized fish. Hybrid tackle fills this gap with strong, durable tackle that will stand the pressures of big fish and big catches. The Hybrid tackle range is designed to meet the needs of fishing on modern commercial fisheries.

Hybrid Power Mono

Primarily designed for hook-lengths and pole rigs, This superb high-tech and high-quality co-polymer line specially formulated for demanding big-fish situations. The line offers brilliant abrasion resistance, knot strength and breaking strains but is remarkably supple to allow perfect bait presentation. Superstrong, supertough and supersupple.

Code	Ø/mm	Bs kg	Bs lbs	Length
2210 012	0.12 mm	1.70 kg	3.70 lbs	100 m
2210 014	0.14 mm	2.55 kg	5.60 lbs	100 m
2210 016	0.16 mm	3.00 kg	6.70 lbs	100 m
2210 018	0.18 mm	3.90 kg	8.50 lbs	100 m
2210 020	0.20 mm	4.20 kg	9.20 lbs	100 m
2210 022	0.22 mm	5.00 kg	11.00 lbs	100 m
2210 024	0.24 mm	5.90 kg	13.00 lbs	100 m

Colour: clear-grey
Retail pack of 1 – Trade unit: 10 packs



Adam Richard (UK)



Hybrid Distance Bomb

Shaped leads that fly like bullets and enter the water quietly. The flat sides give maximum resistance to fish for bolt style rigs and fishing. These shaped leads also hold bottom better than conventional leads when river fishing allowing smaller weights to be used.

Code	Bs g	Bs oz	P/Pack
6014 014	14 g	0.50 oz	3
6014 021	21 g	0.75 oz	3
6014 028	28 g	1.00 oz	2

Trade unit: 5 packs



Braid Scissors

Sharp, fine scissors for hard-to-cut braid but also good for cutting or trimming everything else.

Code	Model
6409 001	Braid Scissors

Trade unit = 5 pieces



Hybrid Match Quick Melt PVA

Fast melt, non-toxic, PVA mesh in popular 23 and micro 18 mm diameters. The micro tube is perfect for hard winter fishing when small amounts of feed are required, and also for long distance casting where a slim bag is more aerodynamic.

Code	Ø	Length
2606 001	18 mm	5 m
2606 002	23 mm	5 m

Trade unit: 5 packs



Knot Picker

An essential tool for every angler. Sharp point and fast taper for unravelling wind knots and loops but also has 101 other uses like clearing varnish from float eyes.

Code	Model
6325 012	Knot Picker

Trade unit = 5 pieces

Double End Mega Punch

Compact set of punches in larger than average bait sizes. Set comprises 2 punches giving 17, 15, 13 & 11 mm bait sizes.

Code	Model
6325 011	Double End Punch

Trade unit = 5 pieces



EXTRA LARGE

HYBRID

BETTER THAN AVERAGE TACKLE FOR BETTER THAN AVERAGE FISH!

Hybrid Luggage

Made in a durable, wipe-clean and waterproof material. Unlike conventional "canvas" style luggage, Hybrid luggage can be easily wipe-cleaned before packing in the car after a wet and muddy session! Keep your gear clean and dry on even the wettest of days.



Hybrid Match Holdall

A compact, full zip, match-style holdall with enough space for the typical modern match angler. Will accommodate at least 8 tubes but the internal design gives total flexibility on the sizes of tubes carried. The large and long single front pocket has a long zip for access and can be used to carry long and bulky items like box legs.

Code	Length	Size
8525 002	1.93 m	13 x 25 cm



100% Nylon, PVC coated

Hybrid Specialist Holdall

Will carry up to 8 tubes in a large single compartment and has a full length exterior pocket with long zip for banksticks, net handles, buzzer setups etc. Also has a useful exterior "quiver" which allows a wet umbrella to be carried outside the main holdall so protecting rods.

Code	Length	Size
8525 001	1.93 m	12 x 20 cm



Hybrid Match Carryall

A medium-large carryall for the match oriented angler. Has a very deep front pocket that will carry multiple side trays and landing net heads. The main compartment is partitioned so that tackle, food and clothing can be kept separate from bait – also eliminates the "big sack" effect encountered with large single compartment carryalls!

Code	Size
8525 004	50 x 40 x 30 cm



100% Nylon, PVC coated

Hybrid Specialist Carryall

A medium sized carryall, nicely compact but with enough space for most anglers' needs – and a practical alternative for anglers needing something smaller than large match-style carryalls. The carryall has three useful front pockets and wide twin-zip top opening for easy access to the main compartment. Padded handles and shoulder strap make the bag easy and comfortable to carry.

Code	Size
8525 003	55 x 35 x 28 cm



Nylon 300D, PU coated



Hybrid Groundbait Bowls

2 convenient sized bowls in a durable, wipe-clean material. Large diameter but shallow for easy mixing of small and medium quantities of groundbait.

Code	Model	Size
8525 010	M	25 cm x 12 cm
8525 011	L	35 cm x 15 cm



HYBRID

BETTER THAN AVERAGE TACKLE FOR BETTER THAN AVERAGE FISH!



Match Carp Tool Kit

A fantastic solution for all anglers who frequently visit commercial carp waters. Every important tool in one secure case, including a rig board for storing leaders situated internally. Contains two boilie and pellet drills, a threader, a knot picker, three boilie needles, a disgorger, braid scissors, forceps and three bait punches, as well as 10 rig board needles.

Code	Model
6603 001	Match Carp Tool Kit



Mini Carp Match Tool Kit

A more compact version of our popular Match Tool Kit with the tools essential for hair-rigging baits. Store your tools and hook-lengths in one place and they'll never get lost again!

Code	Model
6603 005	Mini Match Carp Tool Kit



Hybrid Speed Scooper

A much more manageable, mid-sized version of the traditional but unwieldy large specimen net design. The reduced dimensions make the net compact and easy to use but is still easily big enough for double-figure fish. With strong but light glass-fibre arms, all metal spreader block and fish-friendly knotless mesh.

Code	Size	Mesh size
7029 023	70 x 70 x 50 cm	6 mm



Hybrid Landing Net Head

Strong reliable landing nets. The net mesh is held inside the frame for strength and to minimise line damage when unhooking fish. The frame shape design helps when netting large fish. Available in medium and large sizes.

Code	Size	Mesh size
7029 020	M (50 x 40 x 30 cm)	10 x 5 mm
7029 021	L (55 x 45 x 40 cm)	10 x 5 mm



Hybrid Spacesaver Keepnets

Designed to be light in weight and compact, but without sacrificing strength.

Ideal for multi-net or long walk situations as they take half the space of conventional nets when folded. Covered wire bottom rings are strong, sink quickly and resist wear.

Open mesh is fish-friendly and dries quickly. AVAILABLE IN 3 SIZES including a long 4 meter version for rivers where the open mesh and heavy solid wire rings make the net sink fully without the need for extra weights. The perfect River keepnet!

Code	Length	Size
7046 250	2.65 m	42 x 35 cm
7046 300	3.00 m	40 x 50 cm
7046 400	4.00 m	40 x 50 cm



Hybrid Power Scooper

A 3 meter, 3 piece carbon „no nonsense“ landing net handle designed to be very stiff for „scooping“ fish sub-surface. Light in weight but very very strong due to a special carbon composition. Perfect for those who find standard match-style carbon landing net handles too weak. The handle has a riveted screw net fitting for durability and strength.

Code	Model	Length	Sections	Tr.-Length	Weight
7172 300	Hybrid Power Scooper	3.00 m	3	1.10 m	290 g



Hybrid Long'n Short Scooper

An extremely strong multi-length handle with two purposes. The first section is 1.8 meters long and can be used on its own as a conventional handle for specimen sized nets. It has an EVA grip at the top and a heavy-duty riveted steel thread.

Add the 1.2 meter extension and you have a strong 3 meter handle suitable for all styles - and particularly useful if you need extra length for high banks or marginal weed.

Code	Model	Length	Sections	Tr.-Length	Weight
7160 300	Hybrid Long'n Short Scooper	3.00 m	2	1.78 m	460 g

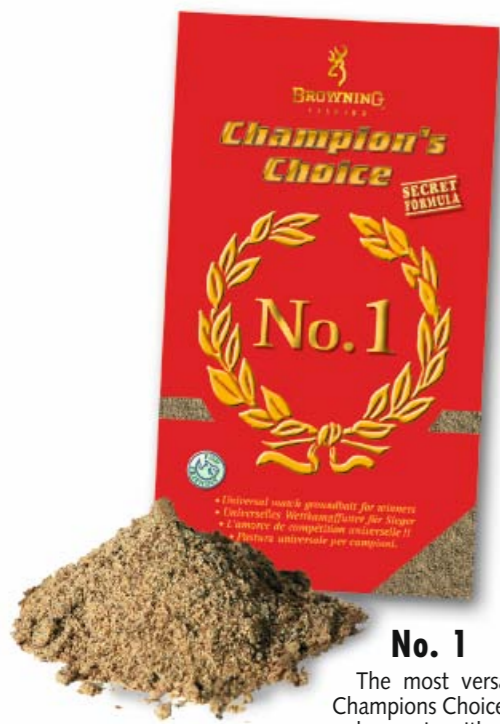

No. 1

The most versatile groundbait in the Champions Choice line. No. 1 can be used as a base mix with all of our other groundbaits. It is suited for very dry use as an explosive feeder mix or watered down for use on lakes and rivers. This mix has been used successfully for years by the Browning Team, which is a testament to its quality. The dark colour comes solely from the use of natural flours. The slightly bitter aroma of this groundbait holds fish in the swim for long periods. Grain size: medium – fine.

Code	Model	Contents
3970 001	No. 1	1 kg

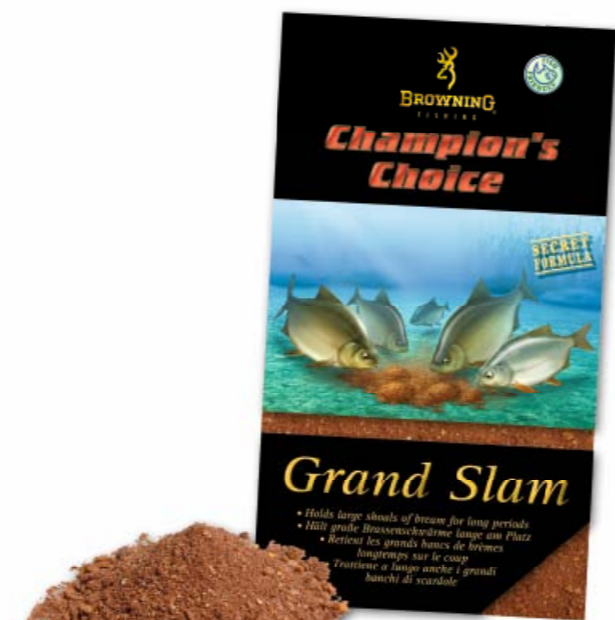

Grand Slam

Brown groundbait for enticing shoals of bream. A sweet groundbait which is both intensively attractive and highly adhesive, making it perfectly suited to mixing with large volumes of bait and/or particles. Grand Slam is particularly successful when used in conjunction with chopped worms and casters. Even large specimen bream are held in the swim for long periods. Grain size: large. Adhesion: strong.

Code	Model	Contents
3970 015	Grand Slam	1 kg



M7

Legendary Dutch feeder groundbait for use on lakes and rivers. For stillwaters, M7 is soaked an hour before fishing and passed through a medium sized sieve to retain its explosiveness. For rivers, M7 should be soaked the evening before fishing to ensure that it sinks properly without floating particles being carried away. Moisten again slightly before fishing and pass through a medium sized sieve. With M7, even the smallest quantities of groundbait can hold large groups of fish in the swim for long periods. The groundbait is very filling and has a sweet scent and flavour. Grain size: large.

Code	Model	Contents
3970 002	M 7	1 kg



River

An allround match fishing groundbait with very strong binding properties and long lasting effect, suitable for all large fish and bream in particular. River is perfect for use on large flowing rivers with plenty of boat traffic. This groundbait can be combined with large quantities of particles to keep fish searching throughout your match. Its unique blend of aromas is virtually unbeatable. With the addition of a little water the groundbait can also be used to good effect at long distances with the match rod. Grain size: medium.

Code	Model	Contents
3970 003	River	1 kg

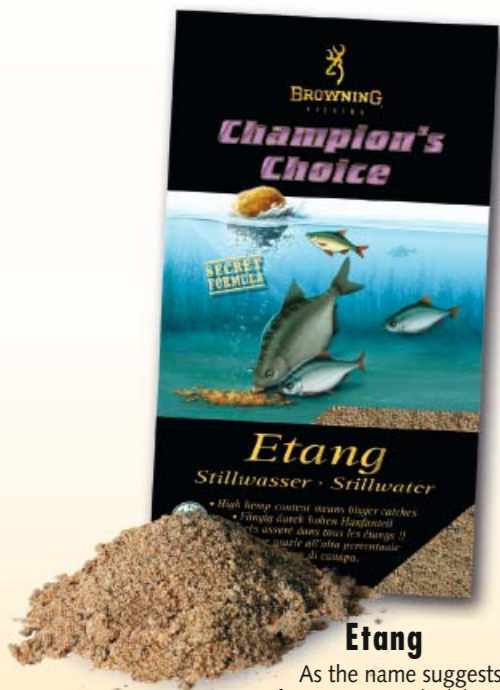

Etang

As the name suggests, this groundbait is ideal for use on ponds, lakes and slow flowing water. The groundbait is highly active in the water and has a high crushed hemp content, which attracts fish to the swim from long distances. The combination of attractors is irresistible to large bream and roach. Stillwater is perfect for use with bloodworm and joker and mixed on the dry side works in the water for hours. Grain size: small.

Code	Model	Contents
3970 004	Etang	1 kg



Canal

Canal has a distinctly aromatic scent which is irresistible to large roach, bream and silver bream. The groundbait is made from the finest breadcrumb with a roasted aroma and has a low saturation value. Canal is perfect for use with bloodworm and joker as there are no salty ingredients to damage the bait. This low food content brown coloured groundbait is well suited to all types of canal. Grain size: medium.

Code	Model	Contents
3970 005	Canal	1 kg



Big Fish

A heavy, bright yellow groundbait for large fish such as bream, tench and carp. The strong binding properties and long lasting effect ensures that this groundbait holds large groups of fish for sustained periods. This groundbait is best combined with large volumes of particles such as maggots, casters, worms and gravel. The sweet scent of almond is irresistible to huge specimens. Big Fish is suitable for use on large rivers and lakes. This groundbait is best mixed wet to ensure an inert mix favoured by large fish. Grain size: large.

Code	Model	Contents
3970 006	Big Fish	1 kg

Improved Formula



Black Magic®

Groundbait for the most difficult conditions! The very dark, almost black colour makes this groundbait perfect for fishing in clear water. The special colouration makes Black Magic® perfectly suited to the lake or river bed, leading the fish straight to the feeding site and keeping them there. Black Magic® has highly active ingredients which roach especially find irresistible. The selected combination of attractors makes the scent and flavour attractive to all types of silver fish. Grain size: medium.

Code	Model	Contents
3970 007	Black Magic	1 kg



Gardons

Specifically developed for targeting larger roach on canals and rivers, Gardons has just the right properties to attract and hold specimen fish in your swim and to keep them feeding. With few active ingredients the fish will concentrate directly on the feeding area. The distinctive aroma of ground spices is irresistible to large roach and bream. Grain size: large. Adhesion: medium.

Code	Model	Contents
3970 011	Gardons	1 kg



Red Roach

A roach groundbait without an equal. The rich red colour of the groundbait provides an unbeatable advantage on coloured waters and in spring. Only the best high quality ingredients are used for Red Roach. The distinctive scent of roasted hemp combined with a special mixture of additives is irresistible to large roach and skimmer bream. Red Roach can be used on slow flowing canals and stillwaters and is perfect for use with blood-worm. Grain size: medium. Adhesion: medium.

Code	Model	Contents
3970 012	Red Roach	1 kg



Friture

When your aim is to net as many small fish as possible in a limited amount of time, you require a groundbait that is both highly attractive and that has a perfect clouding effect. In addition, the ground bait must not be too filling. "Friture" has been specially designed for these requirements. The angler can determine the consistency by regulating the amount of water added. This makes the groundbait suitable for both rivers (wet mix) and stillwaters (relatively dry mix).

Code	Model	Contents
3970 060	Friture	1 kg



Tench

This unique Tench mixture from the 'Champions Choice' groundbait range has been specially designed to attract tench, but also holds a magical appeal for huge bream and carp. The binding strength has been formulated to maximise catch rate in lakes and slow flowing rivers. The groundbait receives its dark colouration from the finest fish meal. The fishy aroma with a subtle hint of sweet biscuit attracts large specimens quickly and holds them in the swim for long periods. Grain size: medium, Binding strength: medium.

Code	Model	Contents
3970 020	Tench	1 kg



Easy Cheesy

Developed for barbel fishing on large rivers, the distinctive parmesan cheese scent is irresistible to barbel. Easy Cheesy contains large red food particles which are slowly released from the balls of groundbait into the current, attracting fish from large distances. The strong binding properties of the groundbait provide a long lasting effect, holding fish in the feeding area. The groundbait can also carry large quantities of live bait and particles. Grain size: large. Adhesion: very strong.

Code	Model	Contents
3970 013	Easy Cheesy	1 kg



Sweet Breams

A vivid yellow groundbait for attracting shoals of specimen bream. The yellow colour becomes even more intensive when wet. Sweet Breams has a unique almond scent which bream simply cannot resist. Principally for use in the summer months the groundbait has good binding properties making it perfectly suited to attracting and holding large shoals on lakes and large rivers. Grain size: large. Adhesion: strong.

Code	Model	Contents
3970 014	Sweet Breams	1 kg



UK style carp groundbait

Three groundbaits were developed specially for the requirements of the English market. To be a successful carp mix in England, all of these groundbaits contain fishmeal and/or spirulina (ground algae) and are finely ground. During testing, our test anglers almost always enjoyed better catches than their neighbours. Guess why?... Make sure you don't miss out on this advantage over the opposition! These three mixes also consist of exclusively natural basic ingredients and flours, meaning that they pose no threat to the environment or the fish.



Code	Model	Contents
3970 009	Lethal Feeder	1 kg
3970 010	Beta. Mus. Mix	1 kg
3970 008	Halibut BBQ	1 kg





Crispy Carp

When it comes to selectively attracting big fish such as carp and bream, and then holding them in the swim for long periods, a very coarse groundbait with plenty of particles is ideal. Crispy Carp binds well and therefore allows large amounts of additional loose feed to be included in the mix. With its light colour and intensive fruity aroma, the groundbait is perfect when large numbers of big fish are expected. As is traditional from Browning, we only use the highest quality ingredients for our Crispy Carp.

The special feature is the cornflakes which give the groundbait an unmistakable appearance.

Code	Model	Contents
3970 040	Crispy Carp	1 kg



Crispy Big Bream

A genuine all-round groundbait for big fish. Mid-coloured so will not spook wary bream etc. The large cornflakes give the groundbait a striking appearance both in the bucket and on the bottom! The mix is enhanced by sweet vanilla to give extra attraction and to hold inquisitive fish in the swim for long periods. Crispy Big Bream is designed for use on stillwaters or slow flowing rivers. It can carry good quantities of live loose feed without binding too strongly and or breaking up.

Code	Model	Contents
3970 041	Crispy Big Bream	1 kg

Reign supreme with King Groundbait! Exclusively developed by the professional Browning Team with ingenious recipes for specialist use. The high quality ingredients have been carefully blended to obtain optimum results. Particular effort has been made to ensure that all King Groundbaits combine easily and work perfectly in conjunction with the tried and tested varieties of the Browning Champions Choice groundbait range and Champions Choice Additive.



Big Roach

For larger roach catches

Code	Model	Contents
3970 054	Big Roach	1 kg

All Seasons

A variety of quality ingredients

Code	Model	Contents
3970 050	All Seasons	1 kg

Allround Match

A versatile mix

Code	Model	Contents
3970 053	Allround Match	1 kg

Available from February 2013!



Competition Groundbait Range

A small range of three much demanded groundbait mixes. Grand Competition is suited to slow flowing water and stillwaters. It's sweet flavoured, light textured and attracts fish like a magnet. River Competition is the ideal groundbait for fast flowing rivers and deep water. It binds well and will carry particles and loose feed to the bottom without breaking up. Method Competition is a special firmly binding mix designed for method feeder fishing. It will stay on a feeder for even the longest of casts but still break up quickly on reaching the bottom without any active particles.

Code	Model	Contents
3970 030	Grand	1 kg
3970 031	River	1 kg
3970 032	Method	1 kg



Long Distance

Strong adhesion

Code	Model	Contents
3970 051	Long Distance	1 kg

River Feeder

For high catch weights

Code	Model	Contents
3970 052	River Feeder	1 kg

Black Monster

Irresistible for specimen fish

Code	Model	Contents
3970 059	Black Monster	1 kg

B22 – the magic returns!

There are certain attractors that draw in anglers and fish alike. The aroma used for “B22” is legendary in angling circles but disappeared from the market for a time. Browning has rediscovered the legend and carried out intensive testing to discover which other feed items could be combined with this signature scent to maximise its effect. „B22” is at its most effective in difficult conditions when the fish need some persuading to feed.

B22 Match

The basic groundbait but with extreme attraction. Best used as part of a mix. In clear water include as 10 to 20% of your groundbait mix. In very coloured water the proportion can be increased to more than 50%. The low binding properties, fine grain size and overall low dimensional weight make B22 highly versatile.

Code	Model	Contents
3970 021	B22 Match	850 g
Trade unit: 12 pieces		



B22 Gardon

In contrast to the standard B22, this groundbait is designed specifically for targeting roach. The hemp and shredded coconut ingredients particularly appeal to roach. The groundbait has low binding properties which rapidly creates a dark carpet of feed on the bottom. The crushed hemp, unique mix of the individual ingredients and magical aroma combine to create a veritable fish magnet in the swim.

Code	Model	Contents
3970 022	B22 Gardon	850 g
Trade unit: 12 pieces		



B22 Feeder

For the first time, the B22 aroma is available in a special feeder groundbait. The shredded coconut and wheat bran included ensure that B22 Feeder binds for casting but rapidly bursts from the feeder when it hits the bottom. The resulting groundbait carpet has a light brown colour laced with fish-attracting red particles that hold fish in the swim for long periods despite the small amount of feed.

Code	Model	Contents
3970 023	B22 Feeder	850 g
Trade unit: 12 pieces		



B22 Aroma Liquid

B22 aroma in diluted form with additional attractors for mixing with groundbait.

Code	Model	Contents
3928 021	Krazy Liquid	250 ml
Trade unit: 6 pieces		



B22 Maggot Dip

Highly viscous maggot dip with concentrated B22 aroma.

Code	Model	Contents
3940 021	Maggot Dip	30 ml
Trade unit: 10 pieces		



B22 Mini Marbles

Mini-boilies for method feeder fishing that are infused with the legendary B22 aroma. Fish on a hair-rig to minimise missed bites.

Code	Contents	Size
3959 021	50 g	8 mm
3959 121	50 g	10 mm
Trade unit: 12 pieces		



B22 Chewies

Paste pellets flavoured with the legendary B22 aroma – highly versatile.

Code	Model	Contents
3974 021	B22 Chewies	100 g
Trade unit: 10 pieces		



Soaked Hemp

Scarcely any other particle bait can hold coarse fish in the swim for longer than soaked hemp. Roach in particular find it irresistible! The main advantage of hemp is that the small, compact grains allow it to be catapulted out and sink to the bottom relatively quickly even in strong currents without being carried away like maggots and casters. Browning hemp has a particularly high proportion of grains with a visible shoot, the most important quality feature! The 250g packet will generally see you through your session.

Code	Model	Contents
3895 001	Hemp	250 g
Trade unit: 10 pieces		



Niger Seed

Particle baits of all varieties are known to hold coarse fish in the swim for extended periods. Roach in particular but also bream go crazy for them! The major advantage of Niger seeds is that the black grains create a stark contrast in a light groundbait mix. The spicy flavour adds extra attraction. Often used in boilie mixes.

Code	Model	Contents
3895 002	Niger Seed	250 g
Trade unit: 10 pieces		



Sesame Seed

Particle baits of all varieties are known to hold coarse fish in the swim for extended periods. Roach in particular but also bream go crazy for them! The major advantage of sesame is that the particles are relatively soft and easy to crack. In addition the light colour of the grain in a dark groundbait mix creates a good contrast while the nutty flavour holds a magical attraction for fish.

Code	Model	Contents
3895 003	Sesame Seed	250 g
Trade unit: 10 pieces		



Rape Seed

Particle baits of all varieties are known to hold coarse fish in the swim for extended periods. Roach in particular but also bream go crazy for them! Rape seed resembles the highly effective hemp but has a smaller grain size. This means that the fish do not become full so quickly, keeping their hungry mouths occupied for longer looking for more seed.

Code	Model	Contents
3895 004	Rape Seed	250 g
Trade unit: 10 pieces		



Crushed Hemp

A Browning speciality: Ground and boiled hemp, supplied in its own juice in an easy to open tin. An inside tip for the angling pros, mix the enticing juice with your groundbait, it can bring some amazing results.

Code	Model	Contents
3894 015	Crushed Hemp	590 g
Trade unit: 12 pieces		



Seed Mix

Seed Mix from Browning: A wonder bait for holding coarse fish in your swim for longer periods. In testing roach, swim, white bream and barbel showed incredible reactions to this combination of seed particles. Sealed in an air tight container, the cooked, expanded seeds retain their irresistible aroma for a considerable time. Feed directly with a pole cup or catapult or mix with conventional groundbait. Ingredients: Hemp, sesame, Niger seeds, rapeseed, water.

Code	Model	Contents
3894 014	Seed Mix	590 g
Trade unit: 12 pieces		

HYBRID

BETTER THAN AVERAGE TACKLE FOR BETTER THAN AVERAGE FISH!



Hybrid Chewies

Soft Pellets have proven to be a real „killer“ bait, and not only for carp as bream, tench and even big roach have developed a real taste for them. Hybrid Chewies are 8 mm in size and come in eight flavour- colour combinations and have been thoroughly tested to be just the right texture and firmness for the hooking or hair rigging. Packed in re-sealable, space saving and stackable boxes of 100g – perfect when the angler wants to have a selection of different baits handy.



Code	Type	Contents	Size
3974 001	Cheese	100 g	8 mm
3974 002	Spicy	100 g	8 mm
3974 003	Mussel	100 g	8 mm
3974 004	Strawberry	100 g	8 mm
3974 005	Halibut	100 g	8 mm
3974 006	White Chocolate	100 g	8 mm
3974 007	Cream Vanilla	100 g	8 mm
3974 008	Monster Crab	100 g	8 mm

Trade unit = 10 packs

Hybrid Magic Marbles

Mini Boilies have become an essential part of modern fishing and are a „must have“ hook bait when fishing „The Method“ for carp, tench, bream and barbel. Hybrid Magic Marbles are available in 8 and 10mm sizes and eight flavour- colour combinations - all top quality and irresistible to fish. Packed in re-sealable, space saving and stackable boxes of 50g .



Code	Type	Contents	Ø
3959 001	Tutti Frutti	50 g	8 mm
3959 002	White Chocolate	50 g	8 mm
3959 003	Monster Crab	50 g	8 mm
3959 004	Pineapple	50 g	8 mm
3959 005	Spicy	50 g	8 mm
3959 006	Cream Vanilla	50 g	8 mm
3959 007	Mussel	50 g	8 mm
3959 008	Shellfish	50 g	8 mm
3959 101	Tutti Frutti	50 g	10 mm
3959 102	White Chocolate	50 g	10 mm
3959 103	Monster Crab	50 g	10 mm
3959 104	Pineapple	50 g	10 mm
3959 105	Spicy	50 g	10 mm
3959 106	Cream Vanilla	50 g	10 mm
3959 107	Mussel	50 g	10 mm
3959 108	Shellfish	50 g	10 mm

Trade unit = 12 packs



Marble Dust

Flavours in a spray bottle. Ideal for giving mini-boilies that extra attraction; particularly with our unflavoured Neon Pop Up Marbles. In 6 tried, trusted and very popular flavours.

Code	Type	Contents
3928 025	Bittermandel	100 ml
3928 026	Garlic	100 ml
3928 027	Sweet Vanilla	100 ml
3928 028	Bloody Liver	100 ml
3928 029	Monster Crab	100 ml
3928 030	Halibut	100 ml

Trade unit = 10 packs



Hybrid Magic Neon Poppies

Four varieties of mini-pop-up boilies with outstanding visibility; perfect for method fishing. Big bream, barbel and tench, and of course carp, find them irresistible.



Code	Type	Contents	Ø
3959 204	Neon White	30 g	10 mm
3959 201	Neon Red	30 g	10 mm
3959 203	Neon Yellow	30 g	10 mm
3959 202	Neon Orange	30 g	10 mm

Trade unit = 12 packs



Artificial Hemp

Every angler knows the frustration of trying to put hemp on the hook! Our artificial hemp stays firmly on the hook and can be used over and over again. Just loosefeed real hemp – perfect!

Code	Model	Contents
3893 016	Hemp	25
Trade unit = 10 pieces		



Artificial Pellets

Exact replicas of conventional fishmeal pellets that are easy to hook or hair-rig without any preparation. Feed conventional pellets and use these as hookbait. Good for avoiding small nuisance fish and for fishing at long range. Will not dissolve so will always be on the hook. Can be re-used many times.

Code	Model	Contents
3893 011	6 mm	10
3893 012	10 mm	10
Trade unit = 10 pieces		



Artificial Casters

Castors – attractive to fish but delicate. These are exact artificial replicas of every fish's favourite food. Useful if being pestered by small fish. Also good for long-distance casting where natural castors can come off mid-flight – don't sit there with a bare hook!

Code	Model	Contents
3893 015	Caster	30
Trade unit = 10 pieces		



Artificial Bloodworm

An artificial version of the most natural of baits. Deadly if fished over chopped-up real worms. Can be used singly or in bunches for bigger fish. Also very good for bleak fishing as large number of fish can be caught without changing the bait.

Code	Model	Contents
3893 010	Bloodworm	30
Trade unit = 10 pieces		



Artificial Monster Corn

Artificial sweetcorn is an absolute bestseller – now, at last, available in Monster Corn size!

Code	Model	Contents
3893 020	green	10
3893 021	fluo orange	10
Trade unit = 10 pieces		



Artificial Tigernuts

One of the most attractive carp baits available – the magical tigernut. Now available in a handy ready-to-use artificial version that needs no preparation and withstands long casting.

Code	Model	Contents
3893 022	light brown	5
Trade unit = 10 pieces		



Artificial Maggots

Available in three colours. Stay firmly on the hook and do not require changing. Ideal when the bites are coming thick and fast.

Code	Colour	Contents
3893 005	red	25
3893 006	white	25
3893 007	luminous	25
3893 008	fluo pink	25
3893 009	fluo yellow	25
Trade unit = 10 pieces		



Artificial Sweetcorn

This artificial sweetcorn can be used directly on the hook or on the hair, where it will not be stolen by feeding fish. Amazingly, our tests showed that fish took the artificial corn as eagerly as the real thing. Obviously the appearance is more important than the texture. And if you are still not confident, you could always dip the artificial corn in a flavouring before use. Swells slightly.

Code	Model	Colour	Contents
3893 000	Sweetcom	yellow	25 pieces
3893 001	Sweetcom	yellow/red	25 pieces
3893 017	Sweetcom	lumo	25 pieces
3893 018	Sweetcom	fluo pink	25 pieces
3893 019	Sweetcom	fluo orange	25 pieces
Trade unit = 10 pieces			



Pellet Bands

Small silicon rings for securing hard pellets to the hook. In two sizes for pellet sizes from 5 to 12 mm.

Code	Contents	Colour
3968 996	3 x 6 pcs	5 > 9 mm
3968 997	3 x 6 pcs	8 > 12 mm
Trade unit = 10 pieces		



Band Aid Forceps

No more fumbling around trying to push pellets onto pellet bands. Take the strain away from this task; fishing is more fun this way. Incl. 10 of each size S, M, L super stretch pellet band.

Code	Model
6325 010	Forceps
Trade unit = 5 pieces	



Pellet Pump

Gone are the days when it took an eternity for pellets to be ready for use. With the Browning Pellet Pump, it takes literally seconds for floating, hard pellets to be saturated with water and become soft and pliable. Simply put pellets and water in the container, close the lid and expel the air from the container with the pump plunger. Then press the valve on the lid and allow the air back in, the pellets are now ready and the lid can be removed.

An indispensable tool for all coarse anglers.

Code	Model	Size
8062 001	Pellet Pumpe	0.50l
Trade unit = 6 pumps		



Aroma

Groundbaits need to be continually improved and enhanced to suit changing water conditions and feeding habits of fish. By using specialist additives and ingredients, new and original groundbaits can be created that have a fresh and irresistible attraction to fish. A team of Browning test anglers spent weeks collaborating on the composition of the Champion's Choice Aroma range of additives. The result is a selection of sensational mixes, the like of which the market has never seen. Constructed by experts for experts and aspiring experts of the future.

Carp Candy



Code	Model
3932 001	Carp Candy
250 g bag, Trade unit: 10 pieces	

Big Fish



Code	Model
3932 002	Big Fish
250 g bag, Trade unit: 10 pieces	

M7



Code	Model
3932 003	M7
250 g bag, Trade unit: 10 pieces	

Spicy Roach



Code	Model
3932 004	Spicy Roach
250 g bag, Trade unit: 10 pieces	

Lake Cracker



Code	Model
3932 005	Lake Cracker
250 g bag, Trade unit: 10 pieces	

Bream Blaster



Code	Model
3932 006	Bream Blaster
250 g bag, Trade unit: 10 pieces	



Krazy Sweetner

'Krazy Sweetner' is the ideal solution for sweetening groundbait. Carp, bream, tench and other silver fish love a sweet flavour. Krazy Sweetner is many times sweeter than ordinary sugar and is made from sodium-saccharin (around 300 times sweeter than sugar), NHDC (around 1,500 times sweeter) and purely natural, intensely sweetening plant extracts. In contrast with other sweeteners Krazy Sweetner lacks the customary bitter after taste. Recommended dosage: 1 teaspoon per approx. 1-3 liters of groundbait.

Code	Model	Contents
3935 015	Krazy Sweetner	400 ml
Trade unit = 6 pieces		



Krazy Spices

100 % natural! So there is no danger of overdosing as with highly concentrated, artificial flavours. Particularly long lasting effect.

Code	Model	Contents
3933 001	Krazy Spice Coriander	400 ml
3933 002	Krazy Spice Aniseed	400 ml
3933 003	Krazy Spice Cinnamon	400 ml
3933 004	Krazy Spice Fennel	400 ml
Trade unit = 6 pieces		



Krazy Liquid

Highly concentrated liquid additives have become indispensable in match fishing. No matter if you are dipping or mixing for groundbait, these dips are extremely effective and versatile. Krazy Liquid offers a high quality additive with extremely successful results.

Code	Model	Contents
3928 001	Super Caramel	250 ml
3928 002	Super Vanilla	250 ml
3928 003	Super Cocos	250 ml
3928 004	Super Honey	250 ml
3928 005	Super Tutti Frutti	250 ml
Trade unit = 6 pieces		



Krazy Clean

Krazy Clean is indispensable for anglers looking to improve their catch rate. Maggots bought from shops are very greasy and often smell strongly of either ammonia or any other scents. Firstly, sieve the maggots to remove any sawdust. Then sprinkle Krazy Clean over the top (Recommended: 3-5 tablespoons per litre of maggots) and work into the maggots. Result: dry and attractively smelling bait.

Code	Model	Flavour	Contents
3935 011	Krazy Clean	sweet	400 ml
3935 012	Krazy Clean	fish	400 ml
Trade unit = 6 pieces			



Optional holes for dispensing: On one side a large opening provides sufficient access for a dessert spoon, on the other side the lid features a practical diffuser.



Krazy Colour

Code	Model	Colour	Contents
3934 001	Krazy Colour	red	400 ml
3934 002	Krazy Colour	yellow	400 ml
3934 003	Krazy Colour	brown	400 ml
3934 004	Krazy Colour	black	400 ml
Trade unit = 6 pieces			



Krazy Glue

'Krazy Glue' is perfect for forming handfuls of maggots into small balls. Simply remove any sawdust from the maggots and to achieve maximum results preferably clean with Browning Champions Choice 'Krazy Clean'. Then add a little water but do not get the maggots too wet. Then sprinkle Krazy Glue over the top. Slowly mould the maggots together to form the desired ball size. You may want to add in some grit previously to make the balls heavier. Once completed the balls will break up quickly in the water.

Code	Model	Contents
3935 010	Krazy Glue	400 ml
Trade unit = 6 pieces		



Browning Match Dips

Highly attractive match dips with an intensive aromatic effect. Sticks firmly to all types of bait and dissolves slowly in the water. Makes ordinary baits into irresistible morsels!

Code	Model	Colour	Contents
3940 001	Garlic Unlimited	white	30 ml
3940 002	Creamy Bream	red	30 ml
3940 003	Tutti Frutti	yellow	30 ml
3940 004	Vanilla Sky	transparent	30 ml
3940 005	Ginger Storm	brown	30 ml
3940 006	Fishy Fingers	brown	30 ml

Trade unit = 10 pieces

Champions Choice XTC Aroma

In match fishing, small differences can have a big impact. With additives in particular, only the highest quality will produce success on the water. The Browning XTC range is highly concentrated and has been so finely tuned in terms of taste that the fish are magically held in the feeding ground. Recommended dose 1-3 tablespoons per 1 l of groundbait.

Code	Model	Flavour	Contents
3929 001	CC XTC	Super Vanilla	225 g
3929 002	CC XTC	Super Karamell	225 g
3929 003	CC XTC	Super Spekulatius	225 g
3929 004	CC XTC	Super Zimt	225 g
3929 005	CC XTC	Super Toffee	225 g
3929 006	CC XTC	Super Kokos	225 g
3929 007	CC XTC	Super Mandel	225 g

Trade unit = 6 pieces



Tackle maintenance products are essential when it comes to extending the life of your fishing tackle. Browning offers a range of five different products for all kinds of gear.

Reely Greasy

Reely Greasy protects reel gears from wear, abrasion and corrosion. With its PTFE-based formula, developed during extensive testing, it offers excellent properties at both high and low ambient temperatures and with sudden changes in temperature. In addition, Reely Greasy provides optimal adhesion to gear components.

Code	Model	Contents
9700 005	Reely Greasy	200 ml

Trade unit = 6 pieces



Clean & Care

Clean & Care lubricates, cleans and cares for all types of rubber, plastic and metallic surfaces. After application, Clean & Care is neutral in smell and taste, watertight and weather resistant. Ideal for prolonging the life of your fishing tackle.

Code	Model	Contents
9700 007	Clean & Care	200 ml

Trade unit = 6 pieces



Super Slippy

Super Slippy is a universal lubricant which, when dry, forms a thin film with an extremely low friction coefficient and provides extreme slippage and excellent anti-stick properties. The barely visible and highly adherent PTFE film contains no grease, oil or silicone and so does not attract dust particles.

Code	Model	Contents
9700 008	Super Slippy	200 ml

Trade unit = 6 pieces



Graphite Grease

Graphite Grease comes into its own when moving parts must be kept free-moving and free from corrosion, such as frequently used reels or rod joints. Graphite Grease is a particularly resilient lubricant, that can withstand even high pressures.

Code	Model	Contents
9700 009	Graphite Grease	200 ml

Trade unit = 6 pieces



Wax Shield

Wax Shield makes it possible to seal the surfaces of angling equipment. Rods and poles in particular can be protected from dirt and wear for the long term. Simply spray on, dry and rub briefly where necessary - the surfaces will be instantly and visibly smooth and shiny.

Code	Model	Contents
9700 006	Wax Shield	200 ml

Trade unit = 6 pieces



Delivered 2 x 6 pcs.

Browning pole and match lines have been specially developed using an advanced macro-molecular process. This increases breaking strains and knot strength but retains the line's suppleness and stretch. These are amongst the softest yet strongest lines available on the market today.

Cenex

We believe that this is the softest yet strongest match line available on the market today. High-tech and perfect for hook lengths and pole rigs. The smooth surface finish and consistent diameter eliminates kinking when tying hooks. Cenex has a loyal following - including World Champion Bob Nudd!

50 m

Code	Ø/mm	Bs kg	Bs lb/oz	Length
2207 306	0.06 mm	0.40 kg	0.9 lb	50 m
2207 307	0.07 mm	0.50 kg	1.0 lb	50 m
2207 308	0.08 mm	0.70 kg	1.5 lb	50 m
2207 309	0.09 mm	0.80 kg	1.7 lb	50 m
2207 310	0.10 mm	1.00 kg	2.0 lb	50 m
2207 312	0.12 mm	1.50 kg	3.0 lb	50 m
2207 314	0.14 mm	2.00 kg	4.0 lb	50 m
2207 316	0.16 mm	2.90 kg	6.0 lb	50 m
2207 318	0.18 mm	3.10 kg	7.0 lb	50 m
2207 320	0.20 mm	3.75 kg	8.0 lb	50 m

Colour: clear-grey
Retail pack of 1 - Trade unit: 10 packs

100 m

Code	Ø/mm	Bs kg	Bs lb/oz	Length
2207 008	0.08 mm	0.70 kg	1.5 lb	100 m
2207 010	0.10 mm	1.00 kg	2.0 lb	100 m
2207 012	0.12 mm	1.50 kg	3.0 lb	100 m
2207 014	0.14 mm	2.00 kg	4.0 lb	100 m
2207 016	0.16 mm	2.90 kg	6.0 lb	100 m
2207 018	0.18 mm	3.10 kg	7.0 lb	100 m
2207 020	0.20 mm	3.75 kg	8.0 lb	100 m

Colour: clear-grey
Retail pack of 1 - Trade unit: 10 packs

PREMIUM QUALITY LINE
CENEX

Ultra slim 50m spools take less space in tacklebox

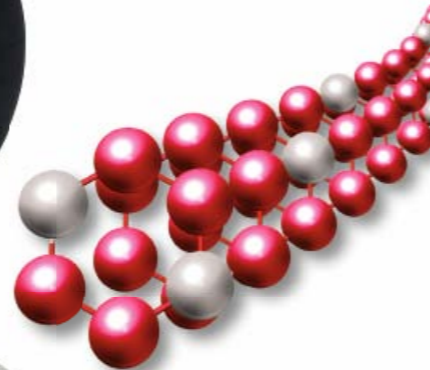

Black, low stretch alternative to braid - 150m spool size



Cenex Feeda Line

A specialist, black, low stretch feeder line that is an easier to use alternative to braid. The line has a specially sealed, smooth surface seal which both improves casting and makes it highly abrasion resistant - a useful attribute when fishing over stones and gravel bars.

Code	Ø/mm	Bs kg	Bs lb/oz	Length
2209 016	0.16 mm	2.30 kg	5.20 lb	150 m
2209 018	0.18 mm	2.70 kg	6.10 lb	150 m
2209 020	0.20 mm	3.40 kg	7.50 lb	150 m
2209 022	0.22 mm	4.40 kg	9.80 lb	150 m
2209 026	0.26 mm	5.60 kg	12.30 lb	150 m

Colour: black
Trade pack - 10 spools

For an extra strong pole/hooklength line for commercial carp fishing, see our Hybrid Powermono on page B62.



Cenex Feeder Gum

An important buffer line for feeder rigs. With a length of feeder gum even heavy feeders can be fished with thin main lines. 10 m spools.

Code	Ø/mm	Length
6006 108	0.8 mm	10 m

Trade unit: 10 spools

Perfect slow sinking line for waggler fishing - 150m spool size

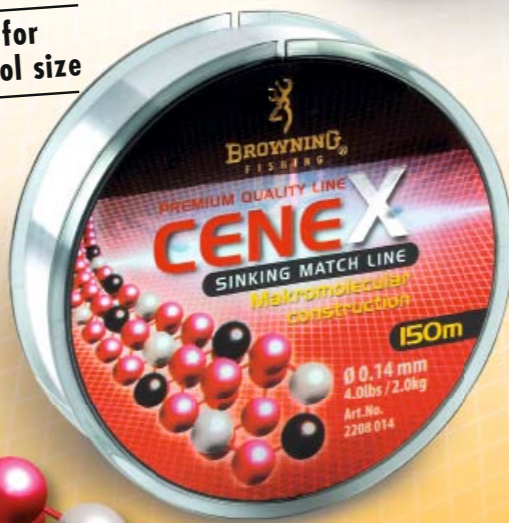

Cenex Sinking Line

Anybody who has fished with a waggler at long distances knows the frustration of line drift. Wind or currents can make the rig uncontrollable as the line drifts into a bow on the surface. Cenex Sinking Match Line sinks quickly and easily without the need to degrease with washing up liquid or other agents.

150 m

Code	Ø/mm	Bs kg	Bs lb/oz	Length
2208 014	0.14 mm	2.00 kg	4.0 lb	150 m
2208 016	0.16 mm	2.40 kg	5.0 lb	150 m
2208 018	0.18 mm	2.80 kg	6.0 lb	150 m
2208 020	0.20 mm	3.50 kg	7.0 lb	150 m
2208 022	0.22 mm	4.50 kg	9.0 lb	150 m

Colour: clear-grey
Retail pack of 1 - Trade unit: 10 packs



Ian Swanson (GB)

Photo IYCF / Bauer Media



Skanderborg Waggler

Loaded waggler for fishing over long distances. Interchangeable tip sets are available as accessories and also fit the "Holme Pierrepont" model.

Code	Weight	Size
5120 001	4 g	1 g
5120 002	6 g	2 g
5120 003	4 g	4 g
5120 004	6 g	4 g
5120 005	6 g	6 g
Various antennas, 8 pcs		
5120 999		
Various hollow antennas, 6 pcs		
5120 998		

Holme Pierrepont Waggler

Super heavy, fully self cocking waggler. The required shot weight is obtained by removing individual weighting discs.

Code	Weight*
5121 001	6 g
5121 002	8 g
5121 003	10 g
5121 004	12 g
5121 005	14 g
5121 006	16 g
5121 007	18 g
5121 008	20 g
5121 009	25 g
5121 010	30 g
spare weights, 6 pcs	
5121 999	

* float will come self cocking



Peacock Waggler No.1

Classic loaded waggler with long peacock feather tip for optimal bite recognition at long distances. First class finishing with durable paint on the tip. Available in five weight categories.

Code	Size
5093 001	3AAA / 2.4 g
5093 002	4AAA / 3.2 g
5093 003	5AAA / 4 g
5093 004	3SSG / 4.8 g
5093 005	4SSG / 6.4 g

Peacock Waggler No.2

Classic loaded waggler with long thin peacock feather tip for optimal bite recognition. First class finishing with durable paint on the tip. Available in five weight categories.

Code	Size
5094 001	3BB / 1.2 g
5094 002	4BB / 1.6 g
5094 003	3AAA / 2.4 g
5094 004	4AAA / 3.2 g
5094 005	5AAA / 4 g



Zoomer

Fantastic waggler with a low loading to weight the rig towards the bottom and sink the bait quickly. One of the most demanded floats in recent years.

Code	Model	BS
5080 001	Power Zoomer	6
5080 002	Power Zoomer	8
5080 003	Power Zoomer	10
5080 004	Power Zoomer	12
5080 005	Power Zoomer	14
5080 006	Power Zoomer	16
5080 007	Power Zoomer	20
5080 999	Antenna Set, 5 Pcs.	
Trade unit = 5 pieces		

Streamrunner

Flat float with wings for presenting baits securely on the bottom. Indispensable when targeting large specimens on rivers. While rounded floats positively vibrate when holding back in turbulent waters, the Streamline, with its intelligent, hydrodynamic design and lateral stabilising wings, stands firm in the water even when the waves are rising. The silky smooth movements of the float ensure the bait is presented firmly on the bottom even in choppy waters meaning no specimen will swim by without noticing your offering. Even in autumnal currents, the flat float provides optimal bait control and a direct line to the fish. The Streamline also features interchangeable tips to allow optimal adaptation to all light conditions. The height of the hollow tips on the carbon body is also adjustable.

Code	Model	BS
5155 001	Streamrunner	10 g
5155 002	Streamrunner	15 g
5155 003	Streamrunner	20 g
5155 004	Streamrunner	25 g
5155 005	Streamrunner	30 g
5155 006	Streamrunner	12 g
Trade unit = 3 pieces		

Flowrider

A tapered flat float ideal when holding back the bait for specimen bream, but a reliable performer whatever the quarry. The Flowrider also comes into its own when targeting weighty roach in a light drift. The razor-sharp contours of the float cut straight through the current providing unprecedented direct bait control.

On the strike, the Flowrider lifts out of the water without resistance meaning just a light strike of the pole will suffice and avoiding snapping those light hooklengths. Canal anglers targeting large specimens with light tackle on the whip will be at a considerable advantage with the Flowrider. Interchangeable tips mean the float can be adapted to changing light conditions in the blink of an eye. The position of the hollow tips on the carbon body is also adjustable.

Code	Model	BS
5154 001	Flowrider	4 g
5154 002	Flowrider	6 g
5154 003	Flowrider	8 g
5154 004	Flowrider	10 g
5154 005	Flowrider	12 g
Trade unit = 3 pieces		

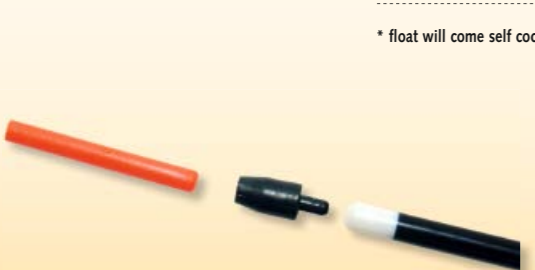
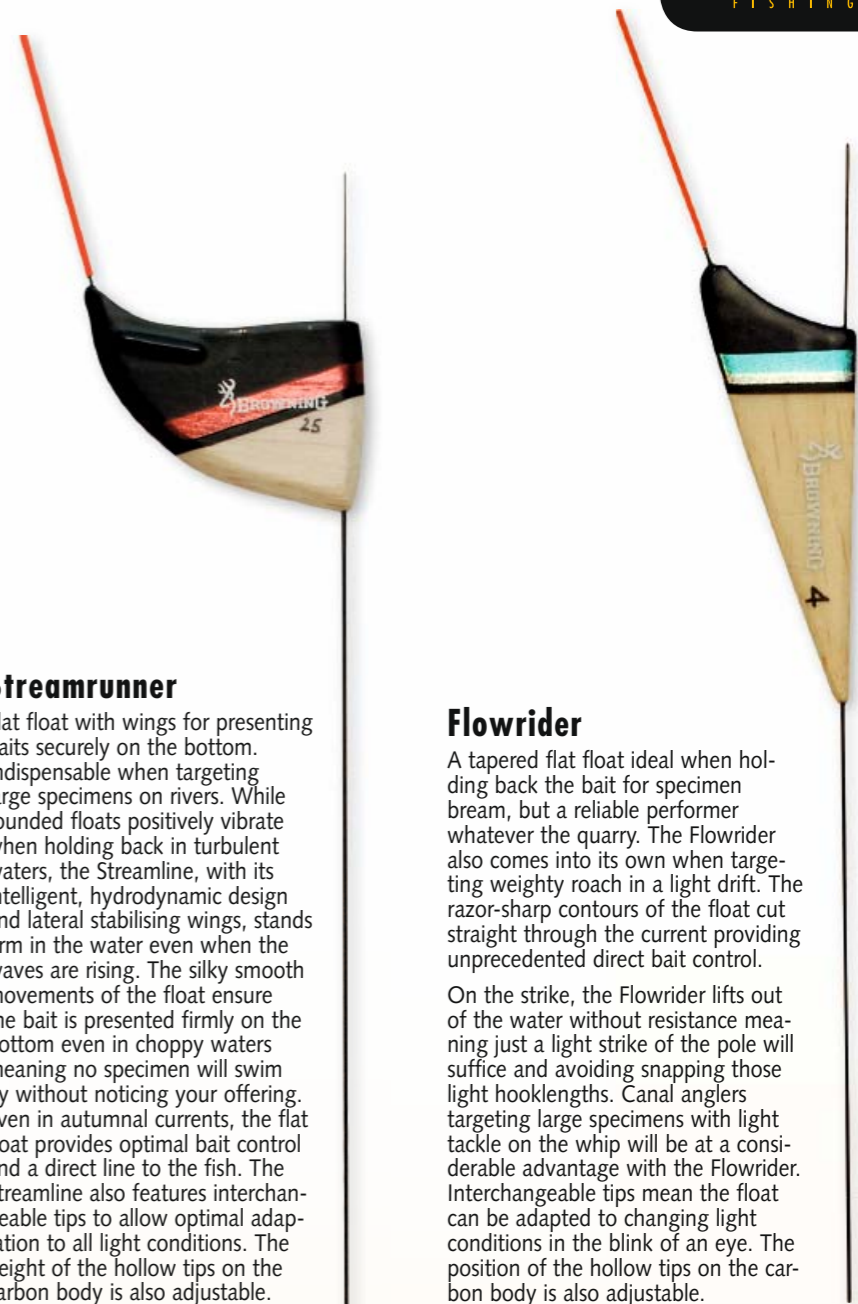

Snap-light adapter

Suitable for Skanderborg and Holme Pierrepont Wagglers.

Code	Model
5120 997	Adapter, 5 Pcs



Waggler Adapter

Simply pushes onto a waggler – the perfect sliding float attachment.

Code	Model	P/Package
6148 002	Waggler Adapter	5
Trade unit = 10 pieces		



Big Waggler Adapter

The ultimate, stainless steel, quick-change waggler adapter for large floats. Can also be used to attach swimfeeders to allow tail length (distance to hook) to be easily changed.

Code	Model	P/Package
6148 001	Big Waggler Adapter	3
Trade unit = 10 pieces		



Clear Wagglers

Top-quality clear plastic wagglers. These UK made floats are individually tested to ensure the loadings are perfect. Consistent quality means that these floats cast perfectly and remain straight. Sold in clear plastic, free standing, counter-top display packs each containing the 5 most popular sizes of type of float. The display pack contains size dividers so retains its shape as the floats are sold.

Loaded Clear Wagglers – 20 floats each of 5 popular sizes 2BB, 3BB, 4BB, 5BB, 6BB.

Loaded Chemi-Lite Wagglers – the best seller – the solid plastic insert can be pulled out and replaced with a standard sized chemi-lite (Ø 4.5 mm) for night fishing. 30 floats of each 3 popular sizes 2BB, 3BB, 4BB.

Unloaded Clear Wagglers – 20 floats each of 5 popular sizes 4BB, 5BB, 6BB, 7BB, 4AAA.

Code	Model	Size	Content
5124 999	Loaded Clear Wagglers	Set	100
		2BB/0.80 g	20
		3BB/1.20 g	20
		4BB/1.60 g	20
		6BB/2.40 g	20
5126 999	Loaded Chemi-Lite Wagglers	Set	90
		2BB/0.80 g	30
		3BB/1.20 g	30
		4BB/1.60 g	30
5125 999	Unloaded Clear Wagglers	Set	100
		4BB/1.60 g	20
		5BB/2.00 g	20
		6BB/2.40 g	20
		7BB/2.80 g	20
		4AAA/3.20 g	20

MADE IN THE UK



5124 999 5126 999 5125 999

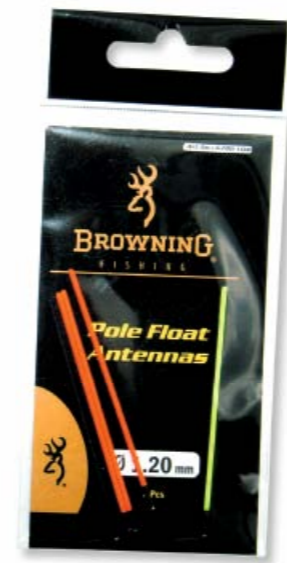

Pole floats with interchangeable tips

Available in the most popular diameters and lengths; 3 x red, 1 x yellow and 1 x black in a self service pack.

Code	Ø	Length	Content
6786 101	0.7 mm	35 mm	5
6786 102	0.9 mm	50 mm	5
6786 103	1.0 mm	60 mm	5
6786 104	1.2 mm	60 mm	5
6786 105	1.5 mm	60 mm	5



Pole floats with hollow tips

Available in the most popular diameters and lengths; 3 x red, 1 x yellow and 1 x black in a self service pack. Also push over thin tips.

Code	Ø	Length	Content
6786 001	1.1 mm	47 mm	5
6786 002	1.2 mm	47 mm	5
6786 003	1.5 mm	55 mm	5
6786 004	2.0 mm	55 mm	5
6786 005	2.5 mm	55 mm	5



5124 999



5126 999



5125 999



Silicone Tubing Set

Indispensable for firmly fixing float to line. Top quality silicone.

Code	Model	Ø mm (Length each 15 cm)
6001 001	Tubing Set	0.60 / 0.80 / 1.00
6001 002	Tubing Set	1.20 / 1.40 / 1.60



Bob Nudd (GB)

H_YBRID

BETTER THAN AVERAGE TACKLE FOR BETTER THAN AVERAGE FISH!

Hybrid Feeders by Kobra

Browning's range of specialist method feeders are hand made in the UK by feeder experts Kobra. These designs are acknowledged as being amongst the best on the market and are used by many top anglers. There is a design for every style including some unique long-distance types.

by *KOBRA*



MADE IN THE UK



Flatty Elasticated

Elasticated flat feeder fitted with medium strength, long-life, black hollow elastic. Available in 2 sizes with 3 loadings.

Code	Model	Size	Weight
6671 020	Flatty Elasticated	S	20 g
6671 030	Flatty Elasticated	S	30 g
6671 125	Flatty Elasticated	M	25 g
6671 135	Flatty Elasticated	M	35 g
6671 150	Flatty Elasticated	M	50 g

Flatty Distance

Unique elasticated flat feeder with long stabilising hollow brass stem that makes the feeder fly straight and true over long distances or in windy conditions. Fitted with medium strength, long-life, black hollow elastic. Available in 2 sizes with 3 loadings.

Code	Model	Size	Weight
6672 025	Flatty Distance	S	25 g
6672 130	Flatty Distance	M	30 g
6672 150	Flatty Distance	M	50 g



Softback Moulds

2 sizes of mould to suit all of our Flatty feeders made in a "non-stick" plastic with a soft back panel which can be depressed to cleanly eject the loaded feeder. They work with dampened pellets or groundbait and ensure a clean release every time. The moulds also fit many other flat method feeders on the market.

Code	Model	Size
6675 001	Softback Mould	S
6675 002	Softback Mould	M



Bob Nudd (GB)



Bjarne Johansen (DK)

New strengthened frames for 2013.



Flatty In-line

In-line running flat feeder. Classic free-running in-line design. Available in 2 sizes with 2 loadings

Code	Model	Size	Weight
6674 020	Flatty In-line	S	20 g
6674 030	Flatty In-line	S	30 g
6674 125	Flatty In-line	M	25 g
6674 135	Flatty In-line	M	35 g
6674 150	Flatty In-line	M	50 g



Pellet Feeder Elasticated

Clear, medium-sized, pellet tube feeder fitted with medium strength, long-life, black hollow elastic. Strong, durable and designed with a long elastic tube positioned at the bottom for ease of loading and maximum "bolt effect". Single size but available in 2 loadings.

Code	Model	Size	Weight
6676 020	Pellet Feeder	M	20 g
6676 030	Pellet Feeder	M	30 g

Pellet Feeder In-line

Clear, medium-sized, pellet tube feeder. Strong, durable and designed with a long line tube positioned at the bottom for ease of loading and maximum "bolt effect". Single size but available in 2 loadings.

Code	Model	Size	Weight
6677 020	Pellet Feeder In-line	M	20 g
6677 030	Pellet Feeder In-line	M	30 g

HYBRID

BETTER THAN AVERAGE TACKLE FOR BETTER THAN AVERAGE FISH!



Hybrid Value Method Feeder Pack

In-line, free-running, method feeder set comprising 2 x 20g and 2 x 30g flat feeders plus a matching mould suitable for groundbait or pellets. Reverse of pack has pictures and instructions for use.

Code	Model	Content
6670 999	Method Feeder Set	2x 20g/2x30g/mould



Hybrid Method Feeders

Top value, 2 per pack, In-line Method feeders complete with swivel. Fits Browning and most other moulds. Available in 20, 30 or 50 g.

Code	Model	Weight	Content
6670 020	Hybrid Method Feeder	20 g	2
6670 030	Hybrid Method Feeder	30 g	2
6670 050	Hybrid Method Feeder	50 g	2

For all articles: Trade unit = 10 pieces



"The Drop" Feeder

A sensational feeder – a revolutionary design with numerous benefits:

- Casts brilliantly and with accuracy
- Has flight properties almost like an end-weight speed feeder.
- With its teardrop shape, frontal line attachment and curved weight, the feeder glides through the water like a sledge. This design causes the feeder to rise to the surface much quicker than a conventional plastic feeder. This gives a fast retrieve and is a huge advantage on waters with rocky or snaggy bottom.
- The feeder retrieves very smoothly without jerking, an advantage for smaller fish like roach or soft mouthed skimmers.
- The feeder is also ideal for use on flowing waters where the bottom positioned weight provides a large contact area and sits flat on the bottom.
- The teardrop shape means the feeder is quick and easy to fill – no lead to obstruct.

Code	Model	Weight	Ø	Length
6666 020	The Drop Feeder M	20 g	2.2 cm	3.5 cm
6666 030	The Drop Feeder M	30 g	2.2 cm	3.5 cm
6666 040	The Drop Feeder M	40 g	2.2 cm	3.5 cm
6666 050	The Drop Feeder M	50 g	2.2 cm	3.5 cm
6666 060	The Drop Feeder M	60 g	2.2 cm	3.5 cm
6666 026	The Drop Feeder L	25 g	2.2 cm	4.5 cm
6666 051	The Drop Feeder L	50 g	2.2 cm	4.5 cm
6666 076	The Drop Feeder L	75 g	2.2 cm	4.5 cm
6666 101	The Drop Feeder L	100g	2.2 cm	4.5 cm

Trade pack - 10 Pieces



Photo IYCF / Bauer Media

Open End Feeder

Classic plastic feeders for use with groundbait. Riveted lead and moulded-in loop for extra durability

Code	Weight	Ø	Length
6663 010	10 g	2 cm	3.5 cm
6663 020	20 g	2 cm	3.5 cm
6663 025	25 g	2 cm	3.5 cm
6663 021	20 g	3 cm	4.5 cm
6663 035	35 g	3 cm	4.5 cm
6663 050	50 g	3 cm	4.5 cm

Trade pack - 10 Pieces

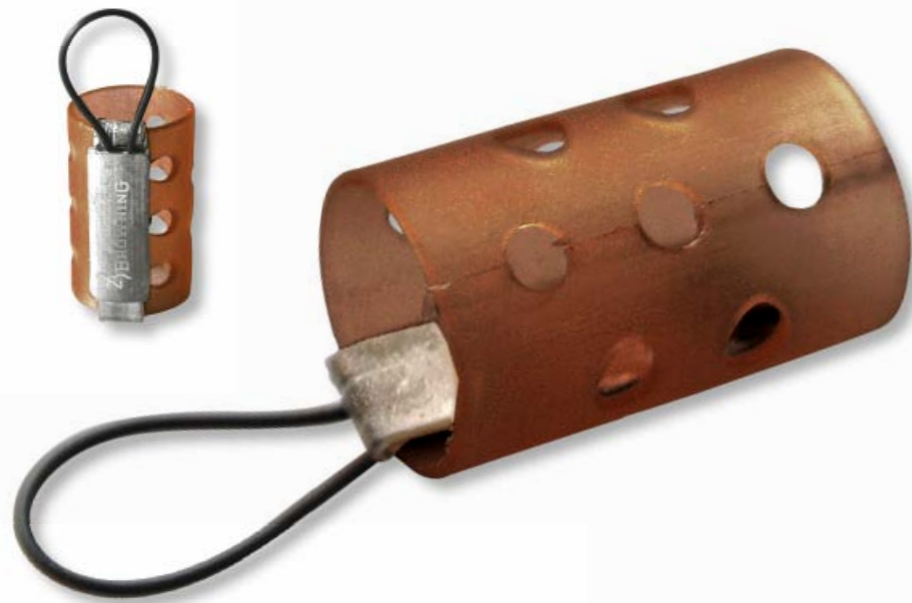

Block End Feeder

Plastic feeder with end caps for use with maggots and other live baits. Hole sizes were optimised during testing to maximise catch rate.

Code	Weight	Ø	Length
6664 010	10 g	2.3 cm	3.5 cm
6664 020	20 g	2.3 cm	3.5 cm
6664 030	30 g	2.3 cm	3.5 cm
6664 021	20 g	2.8 cm	4.0 cm
6664 031	30 g	2.8 cm	4.0 cm
6664 050	50 g	2.8 cm	4.0 cm

Trade pack - 10 Pieces



Window Feeder

Designed by Bob Nudd. With large side opening and a twisting mechanism to vary the opening. Ideal for launching large amounts of live baits quickly and precisely. The opening is smeared with groundbait. Upon contact with the water surface, the maggots and casters explode out.

Code	Weight	Ø	Length
6665 010	10 g	2.0 cm	3.0 cm
6665 020	20 g	2.0 cm	3.0 cm
6665 030	30 g	2.0 cm	3.0 cm
6665 021	20 g	2.3 cm	3.5 cm
6665 035	35 g	2.3 cm	3.5 cm
6665 050	50 g	2.3 cm	3.5 cm
6665 022	20 g	2.6 cm	4.0 cm
6665 036	35 g	2.6 cm	4.0 cm
6665 051	50 g	2.6 cm	4.0 cm

Trade pack - 10 Pieces



Protected Patent

UK Wire Feeder

These wire cage feeders are virtually indestructible. The wire and loop are moulded into the lead giving a one piece feeder that can not come apart - perfect for repeated casting or snaggy conditions.

Code	Weight	Ø	Length
6662 010	10 g	2.5 cm	4.0 cm
6662 020	20 g	2.5 cm	4.0 cm
6662 030	30 g	2.5 cm	4.0 cm
6662 040	40 g	2.5 cm	4.0 cm
6662 021	20 g	3.0 cm	4.5 cm
6662 031	30 g	3.0 cm	4.5 cm
6662 041	40 g	3.0 cm	4.5 cm
6662 051	50 g	3.0 cm	4.5 cm
6662 042	40 g	4.0 cm	6.0 cm
6662 062	60 g	4.0 cm	6.0 cm
6662 082	80 g	4.0 cm	6.0 cm
6662 102	100g	4.0 cm	6.0 cm

bulk - Trade unit: 10 packs

Indestructible stainless steel design!



Easy Speed Feeder

Ideal feeder for fishing at extreme distances. Capable of use on the most diverse range of venues. Rear center of gravity ensures perfect flight qualities.

Code	Weight	Ø	Length
6669 021	20 g	2.2 cm	3.5 cm
6669 031	30 g	2.2 cm	3.5 cm
6669 041	40 g	2.2 cm	3.5 cm
6669 051	50 g	2.2 cm	3.5 cm
6669 061	60 g	2.2 cm	3.5 cm
6669 020	20 g	2.5 cm	3.5 cm
6669 030	30 g	2.5 cm	3.5 cm
6669 040	40 g	2.5 cm	3.5 cm
6669 050	50 g	2.5 cm	3.5 cm
6669 060	60 g	2.5 cm	3.5 cm
6669 080	80 g	2.5 cm	3.5 cm

bulk - Trade unit: 10 packs

Indestructible stainless steel design!

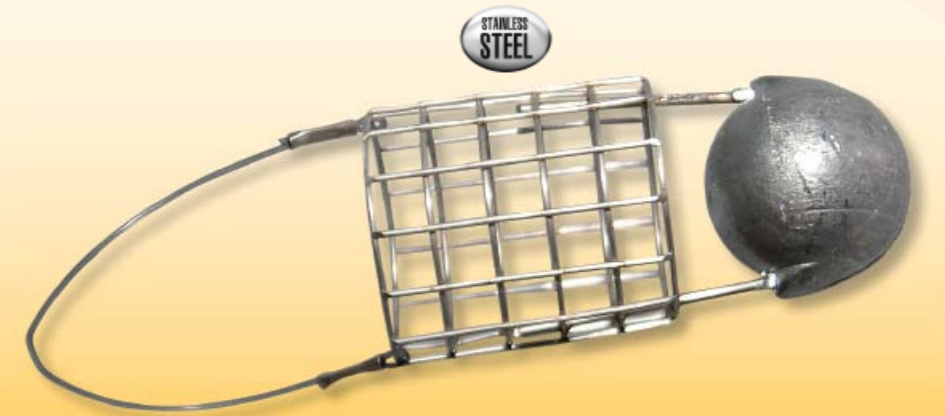

Extremely robust due to the cast lead.



Very large sizes in range - ideal for big rivers and Barbel

Specialist Feeder

Special feeder for use in flowing water, with a flat design enables the lead to hold the bottom particularly well. This allows the angler to use smaller weights than usual.

Code	Weight	Ø	Length
6667 020	20 g	2.7 cm	3.0 cm
6667 030	30 g	2.7 cm	3.0 cm
6667 040	40 g	2.7 cm	3.0 cm
6667 050	50 g	2.7 cm	3.0 cm
6667 060	60 g	2.7 cm	3.0 cm
6667 080	80 g	2.7 cm	3.0 cm
6667 041	40 g	4.0 cm	5.0 cm
6667 051	50 g	4.0 cm	5.0 cm
6667 061	60 g	4.0 cm	5.0 cm
6667 081	80 g	4.0 cm	5.0 cm
6667 101	100 g	4.0 cm	5.0 cm
6667 121	120 g	4.0 cm	5.0 cm
6667 141	140 g	4.0 cm	5.0 cm
6667 161	160 g	4.0 cm	5.0 cm
6667 181	180 g	4.0 cm	5.0 cm

bulk - Trade unit: 10 packs



Feeders loose in a chute – nice and tidy. Attractive product presentation is half the key to a successful sale. Single Browning feeders are well packed and visually appealing to the consumer. Choose from our vast range, all available feeders in the Browning range. Sleek, practical and effortlessly assembled.

Wire Match Small

Code	Model	Contents
6662 997	Wire Match, Small	36 pcs



Wire Match Medium

Code	Model	Contents
6662 998	Wire Match Medium	36 pcs



Wire Match XL

Code	Model	Contents
6662 999	Wire Match XL	36 pcs



Easy Speed

Code	Model	Contents
6669 999	Easy Speed	36 pcs



Specialist M & XL

Code	Model	Contents
6667 998	Specialist M	36 pcs
6667 999	Specialist XL	30 pcs



The Drop

Code	Model	Contents
6666 999	The Drop	30 pcs

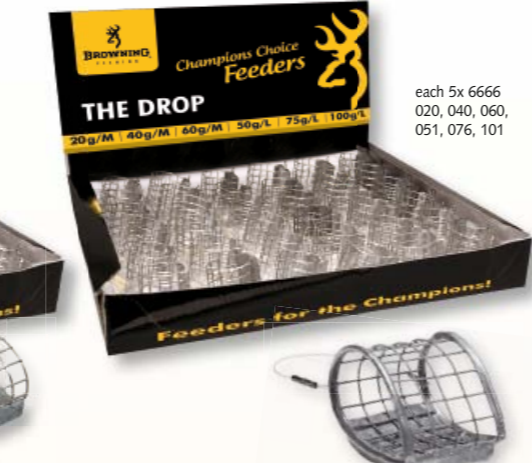

Block End

Code	Model	Contents
6664 999	Block end	36 pcs.



Open End

Code	Model	Contents
6663 999	Open end	36 pcs



Window Feeder

Code	Model	Contents
6665 999	Window Feeder	36 pcs.



Micro Shot Dispenser

Code	Model	Size	Weight
6010 013	Micro Shot Dispenser	13	0.013 g
6010 012	Micro Shot Dispenser	12	0.019 g
6010 011	Micro Shot Dispenser	11	0.028 g
6010 010	Micro Shot Dispenser	10	0.040 g
6010 009	Micro Shot Dispenser	9	0.056 g
6010 008	Micro Shot Dispenser	8	0.070 g
6010 007	Micro Shot Dispenser	7	0.088 g
6010 006	Micro Shot Dispenser	6	0.112 g
6010 005	Micro Shot Dispenser	5	0.135 g
6010 004	Micro Shot Dispenser	4	0.177 g
6010 003	Micro Shot Dispenser	3	0.221 g
6010 002	Micro Shot Dispenser	2	0.271 g
6010 001	Micro Shot Dispenser	1	0.295 g
6010 000	Micro Shot Dispenser	0	0.390 g
6010 200	Micro Shot Dispenser	2/0	0.425 g
6010 300	Micro Shot Dispenser	3/0	0.470 g
6010 400	Micro Shot Dispenser	4/0	0.677 g
6010 500	Micro Shot Dispenser	5/0-AAA	0.690 g
6010 600	Micro Shot Dispenser	6/0-5G	1.180 g
6010 800	Micro Shot Dispenser	8/0-5SG	1.770 g

Trade pack: 10 Pieces



Lead shot in sizes 8 and under can be used in the UK.

Lead Assortments

Code	Model
6010 998	Lead Assortment AAA - SSG - BB - 2 - 4 - 6 - 8
6010 999	Lead Assortment 8 - 9 - 10 - 11 - 12

Trade pack: 10 Pieces



Pole Threader

Unique plastic container, housing a standard diamond eye threading wire which can be wound back inside for safe non tangle transport.

Code	Model
6005 004	Pole Threader

Trade pack: 5 Pieces



Plummet Set

Practical set of three of the most popular plummet sizes in lead free brass design with plastic inserts to protect hooks when attaching to the rig.

Code	Model	Weight
6036 999	Plummet Set	8 g/15 g/20 g

Trade unit = 10 pieces



lead free



Hook length Wallet

Practical for transporting ready made hook lengths.

Code	Model	Size
6603 002	Hook Length Wallet	35 cm
6603 003	Hook Length Wallet	25 cm
6603 004	Hook Length Wallet	40 cm

Trade unit = 5 pieces



Round Rig Wallet

An alternative way of storing hooklengths, however long or short, without kinking and tangling. Round EVA winders stored in a hard tube with zip-up Cordura cover to protect line from the elements.

Code	Ø	Length
8518 027	45 mm	220 mm

Trade unit = 5 pieces

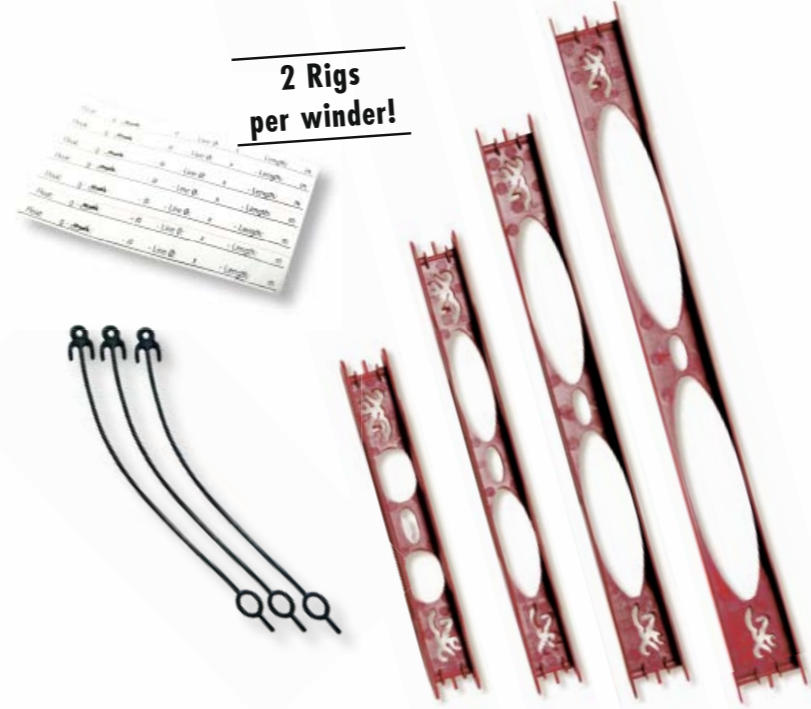

2 Rigs per winder!



Rig Winder

Tried and trusted rig winders to keep your ready made pole float rigs in order. Each winder can take two ready made rigs. Supplied with rubber anchors and stickers for labelling the rigs.

Code	Model	Length	Contents
6784 001	Winder	150 mm	5 pcs
6784 002	Winder	200 mm	5 pcs
6784 003	Winder	250 mm	5 pcs
6784 004	Winder	300 mm	5 pcs
6784 999	Rubber Anchors		10 Pcs.

Retail pack of 5 – Trade unit: 10 packs



Match/Feeder Assortment

Small tub with the most popular swivels for match and feeder angling.

Code	Model
6100 002	Match/Feeder Assortment

Trade unit: 5 packs

Easy Swap Swivel

Practical side mounting system with ready-positioned line stops. Simply tie on and away you go! e.g. for use with wagglers.

Code	Model
6147 001	5

Trade unit = 10 pieces



Instant Snap Swivel

Link swivels for a multitude of uses including quick-changing swimfeeders, bombs etc.

Code	Model
6147 002	5

Trade unit = 10 pieces

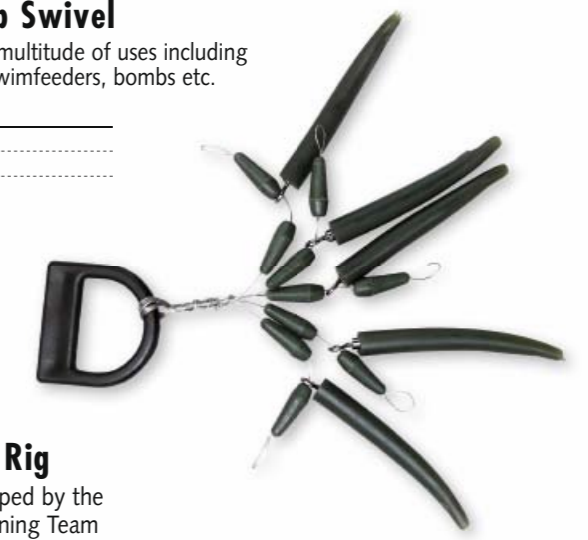

Specialist Feeder Rig

Perfect feeder rig developed by the specialist anglers of Browning Team Denmark. Totally eliminates tangling. Feeders can be changed instantly.

Code	Model
6619 002	Specialist Feeder Rig

Retail pack of 3 – Trade unit: 10 packs

Feeder-Rig I

Code	Model
6619 001	Feeder-Rig I

Retail pack of 3 – Trade unit: 10 packs



Quick Change Swivel

Two special swivels for waggler rigs. In design A the line is threaded into a brass link. In design B the link is coated with plastic.

Code	Model	Size
6142 001	Quick Change Swivel (A)	small
6142 002	Quick Change Swivel	medium
6142 003	Quick Change Swivel	large
6143 001	Adaptor swivel (B)	small
6143 002	Adaptor swivel	medium
6143 003	Adaptor swivel	large

Retail pack of 5 – Trade unit: 10 packs

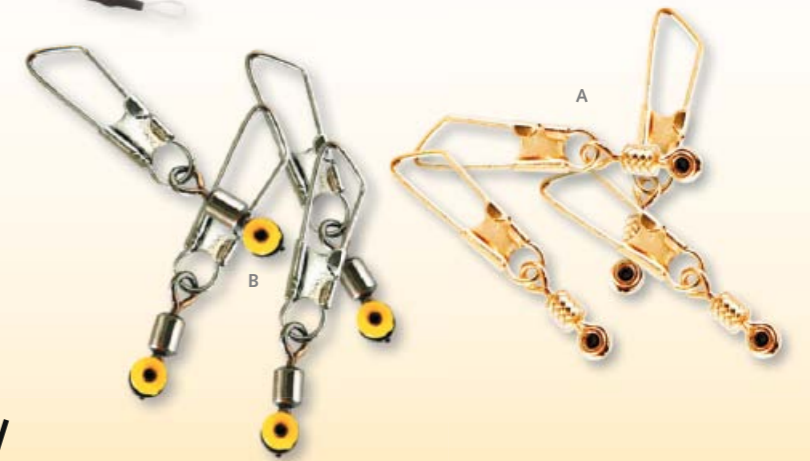

Feeder-Rig II

A tried and tested system for avoiding line tangle when feeder fishing: This loop rig with twirling line.

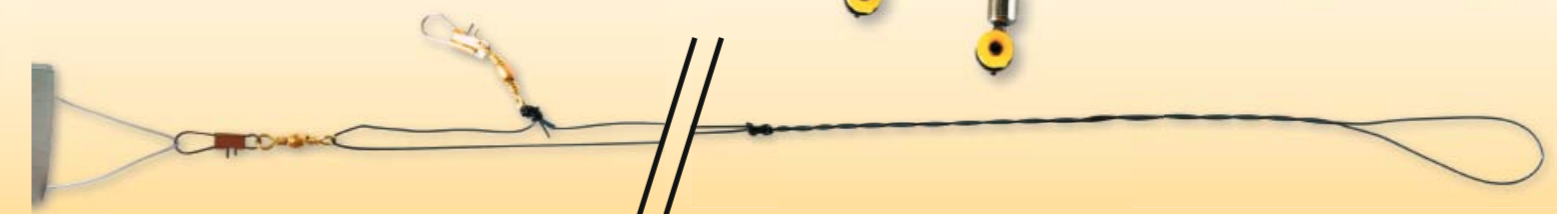

Code	Ø
6620 001	0.25 cm

Retail pack of 3 – Trade unit: 10 packs

Hook Slave

A miracle accessory: a battery powered hook tier that saves hours of fumbling with the business end of the rig. Produces clean knots with optimal line protection during tying. Operated by 2x AAA batteries (not included).

Code	Model
9912 003	Hook Slave
Trade unit = 3 pieces	



Knot Picker / Disgorger

Leaders can knot very easily. But it is not always necessary to change them. With the knot un-picker, the solution is at your fingertips. Including the perfectly designed Browning disgorger.

Code	Model
6325 001	Knot Picker / Disgorger
Trade unit = 10 pieces	

Disgorger

Code	Model	Size
6325 006	Disgorger	11cm
Trade pack: 10 Pieces		

Line Threader

Accessory to help with the threading of main line through the rod rings. Helps in poor light conditions and eliminates those irritating times when you miss a ring or the line slips back just as you reach the tip!

Code	Model
6605 005	Line Threader 10 cm
Trade unit = 5 pieces	

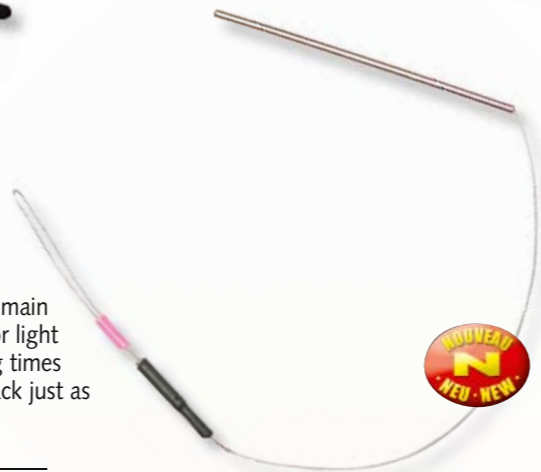

Line Clipper Deluxe

Practical line clipper. Useful for tying rigs or hooklengths.

Code	Model
6409 002	Line Clipper



Browning Fishcounter

Essential when you need to keep on top of the exact number or weight of fish in your net. Especially useful in the UK, where only certain quantities per net are allowed.

Code	Model
9890 010	Browning Fishcounter
Trade unit = 5 pieces	

Catapults

You can simply never have enough of them. Catapults are increasingly called for in modern coarse angling. We offer them in three sizes and supply all spare parts.

Code	Model	Ø Elastic	Size	Contents
6791 001	Match Catapult S	3.0 mm	30 mm	1 (A)
6791 002	Match Catapult S/M	2.5 mm	40 mm	1 (A)
6791 003	Match Catapult M	4.0 mm	50 mm	1 (A)
Trade unit = 5 pieces				
Code	Model	Size	Contents	
6791 101	Spare Pouch S	30 mm	2 (B)	
6791 102	Spare Pouch S/M	40 mm	2 (C)	
6791 103	Spare Pouch M	50 mm	2 (D)	
Trade unit = 10 pieces				
Code	Model	Ø Elastic	Contents	Length
6791 201	Spare Elastic	2.5 mm	1	0.60 m (E)
6791 202	Spare Elastic	3.0 mm	1	0.60 m (F)
6791 203	Spare Elastic	4.0 mm	1	0.60 m (G)
Trade unit = 10 pieces				

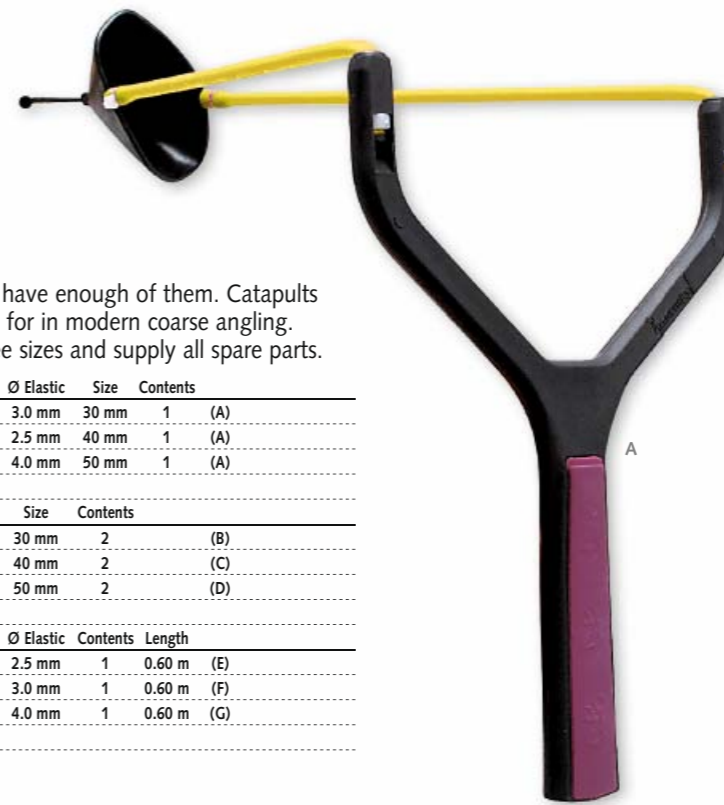

Browning Catapult

A new range of practical and multi-purpose catapults with ergonomic handles. Available with three elastic strengths for the most common uses, all fitted with corresponding pouch size.

Code	Model	Ø Elastic	Size	Contents
6790 001	Catapult S	2.2 mm	30 mm	1 (H)
6790 002	Catapult M	2.6 mm	45 mm	1 (H)
6790 003	Catapult L	3.0 mm	50 mm	1 (H)
Trade unit = 5 pieces				
Code	Model	Size	Contents	
6790 101	Spare Pouch S	30 x 30 mm	1 (I)	
6790 102	Spare Pouch M	45 x 30 mm	1 (I)	
6790 103	Spare Pouch L	50 x 40 mm	1 (I)	
Trade unit = 5 pieces				
Code	Model	Ø Elastic	Contents	Length
6790 201	Spare Elastic S	2.2 mm	1 Set	0.35 m (J)
6790 202	Spare Elastic M	2.6 mm	1 Set	0.35 m (K)
6790 203	Spare Elastic L	3.0 mm	1 Set	0.35 m (L)
Trade unit = 5 pieces				

Browning Latex

Classic pure-white latex is still the choice of many top anglers. This is the very best quality latex available and has been selected for its consistency in diameter and excellent stretch factor. Resists UV damage so has an incredibly long life. Packed in a 3m length to eliminate wastage.

Code	Ø	Length	Colour	Size
6004 001	1.20 mm	3 m	white	8
6004 002	1.40 mm	3 m	white	10
6004 003	1.60 mm	3 m	white	12
6004 004	1.80 mm	3 m	white	14
6004 005	2.10 mm	3 m	white	16

Trade unit: 5 packs



6 meters on spool – perfect for “doubled up” elastic styles

Elastics Super Visibility

Coloured high performance elastics with long life and enormous stretch properties.

Code	Model	Ø/mm	Length	No.
6003 009	blue	0.60 mm	6 m	2
6003 010	yellow	0.70 mm	6 m	3
6003 006	violet	0.80 mm	6 m	4
6003 007	green	0.90 mm	6 m	5
6003 008	fluo yellow	1.00 mm	6 m	6
6003 001	fluo green	1.20 mm	6 m	8
6003 002	pink	1.40 mm	6 m	10
6003 003	orange	1.60 mm	6 m	12
6003 004	red	1.80 mm	6 m	14
6003 005	fluo green	2.10 mm	6 m	16

Trade pack - 5 spools



Xitan Gum Connectors

Our unique version of the very popular way of attaching pole rig to elastic. Our innovative connectors use power gum in place of the normal dacron. The gum link is kinder to line than dacron and always stands clear of the tip so completely eliminates „wrap-overs“. 4 x two colour connectors in a pack.

Code	Model	Contents	Colour
6008 012	Gum Connectors	4	yellow/orange

Trade unit = 10 pieces



Cenex Slip n' Slide

An optimal lubricant for pole elastic with outstanding sliding properties. Spraying builds up an ultra-thin film, which allows the elastic to slide through the top kit for long periods with minimal friction. The film is so thin that no dirt can adhere to it. Suitable for conventional elastics as well as latex and hollow varieties. Does not corrode the elastic. Indispensable for ambitious pole anglers.

Code	Contents
9700 001	200 ml

Trade unit: 6 packs



Reflex Elastics

High quality, double core, brightly coloured hollow pole elastic with perfect stretch characteristics. In 5 sizes from the ultra soft pink, which is ideal for bream and quality “silverfish”, up to the “monster taming” orange.

Code	Model	Ø/mm	Length	Rating
6003 201	pink	1.80 mm	2.85 m	6-8
6003 202	yellow	2.10 mm	2.85 m	8-10
6003 203	blue	2.30 mm	2.85 m	10-12
6003 204	green	2.50 mm	2.85 m	12-14
6003 205	orange	2.85 mm	2.85 m	16-20

Trade pack - 5 Pieces

Tip Connector

Standard accessory, used by anglers in their millions.

Code	Model	Ø	Contents
6007 001	Tip connector	1.0	5
6007 002	Tip connector	1.2	5
6007 003	Tip connector	1.4	5
6007 004	Tip connector	1.5	5
6007 005	Tip connector	1.8	5
6007 006	Tip connector	2.0	5
6007 007	Tip connector	2.5	5

Trade unit = 10 pieces
6007 999 Tip connector Assortment
1.2/1.4/1.8/2.0/2.5 50



Xitan Superbright Connectors

Durable pole connectors in a range of sizes and bright colours. 2 per packet with elastic size guide.

Code	Model	Ø	Length	Pcs.
6064 001	Xitan Connector	3.3 mm	9.0 mm	2
6064 002	Xitan Connector	3.4 mm	13.5 mm	2
6064 003	Xitan Connector	4.0 mm	18.0 mm	2
6064 004	Xitan Connector	5.0 mm	17.0 mm	2
6064 005	Xitan Connector	6.0 mm	20.6 mm	2

Retail pack of 2 – Trade unit: 5 packs



Xitan pure BLACK PTFE external pole bushes

Made from aero quality black PTFE, these external pole bushes are thin walled to create the biggest possible hole size and are designed to eliminate splitting at the rear edge. The black colour is very unobtrusive on the pole. 2 bushes per pack, which has a measurement guide so tip fit size can be checked without removing the bush from packet.

Code	Model	Tip size outer Ø
6063 001	external	3.00 mm
6063 002	external	3.50 mm
6063 003	external	4.00 mm
6063 004	external	4.50 mm
6063 005	external	5.00 mm
6063 006	external	5.10 mm

Retail pack of 2
Trade unit: 5 packs



Medium size fits our Xitan and Carboxy poles perfectly without cutting

Bung Sets

Bungs for rigging elastic with a winder to adjust the tension. Available in three different diameters. Delivered as a set with 3 or 2 bungs and an extractor.

Code	Model	Contents	Ø
6026 001	Bung Set small	3	13.5 mm
6026 002	Bung Set medium	3	20.0 mm
6026 003	Bung Set large	2	28.5 mm

Trade unit: 5 packs



Xitan pure BLACK PTFE internal pole bushes

Made from aero quality black PTFE, these internal pole bushes are short to reduce friction, and thin walled to give the largest possible hole size. The Black colour makes topkits look very smart! 2 bushes per pack, which has a measurement guide so tip fit size can be checked without removing the bush from packet.

Code	Model	Tip size inner Ø
6062 001	internal	3.60 mm
6062 002	internal	4.00 mm
6062 003	internal	4.20 mm
6062 004	internal	4.50 mm
6062 005	internal	4.90 mm
6062 006	internal	5.20 mm
6062 007	internal	5.40 mm

Retail pack of 2
Trade unit: 5 packs

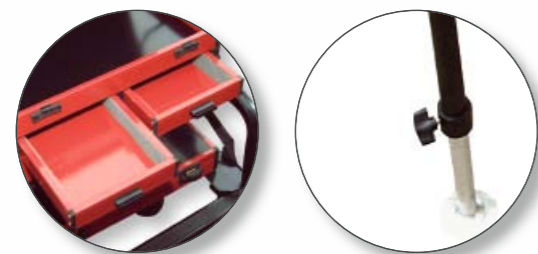

Browning Seatbox Competition Advanced

The element that pushes underneath can be equipped with various modules according to requirements. The modules themselves are fully compatible with the Competition Seatbox and its accessories. Particularly popular with anglers who use a variety of fishing methods and do not always want to rearrange the whole seatbox – simply exchange the element that slides underneath and you are ready!

- Box in modular construction with platform
- Extractable Footrest
- 6 telescopic feet, 25mm Diameter, round, compatible with many systems
- Durable Aluminium mud feet, welded to the legs
- Integrated Trolley System with two large wheels
- Lower Compartment: Flat Drawer, handle integrated lid
- Upper Compartment: 2 front drawers and two flat drawers
- Ergonomically shaped seating surface
- Upholstered strap

Code	Model	
8029 020	Seatbox „Competition Advanced“	(A)
8029 101	Top Cover for Sliding Modul	(B)
8029 102	Basic Sliding Modul	(C)
8029 103	Mud Feet , 2 pcs	(D)
8029 104	Standard Telescopic Leg	(E)
8029 105	Extra-Long Telescopic Leg, 90cm	(F)
8029 106	Extra Telesc. Leg + Ext., 45cm + 30cm	(G)
Trade pack - 2 Pieces (except for 8029 020)		



Xitan Seat Box

A complete seatbox with four external legs, which can be used to attach accessories. With a seat storage area and two front drawers. The highly adjustable and telescopic legs are pleasantly easy to set. Further modules (see page B107) can be added, such as the folding footrest on this page.

- Box with modular construction
- 4 telescopic feet, 25 mm, compatible with many systems
- Box with two front drawers as well as a large upper storage compartment.
- Comfortable upholstered seat with integrated pole holder
- Upholstered strap
- Extremely large mud feet, free folding
- Super easy grip adjusting bolts

Art.-Nr.	Modell
8031 001	Xitan Seat Box



Xitan Foot Platform

An optional addition to the Xitan Seat Box with two telescopic legs. Easy to transport and folds quickly, taking up minimal space in the car. Snaps into place when fishing and bolts tightly.

Code	Model
8031 101	Xitan Foot Platform





Ambition Seat Box

Practical entry level seat box at excellent price. Module compatible with the accessories of the Competition Seatbox (B88/89). Sleek design and lightweight thanks to the aluminium material.

- Box in modular construction with large storage space
- 4 telescopic legs
- 2 front drawers and 1 flat drawer
- Carrying Strap
- Padded seating surface

Code	Model
8029 010	Ambition Seat Box



Feeder Rod Tube Holder

Simple rod tube holder for quickly packing away an unused rod or a top kit, e.g. while unhooking. With mounting for 25 mm leg systems.

Code	Model
8202 001	Rod Tube Holder
Trade unit = 3 pieces	



Standard Pole Bar

Standard Pole Bar design, ultra rigid with EVA supports to protect the pole.

Code	Model
8028 124	Standard Pole Bar



Ambition Pro Seat Box

Value-for-money seat box with four adjustable legs and a side tray included. Extremely easy to carry.

Code	Model
8027 001	Ambition Pro Seat Box
8027 101	Side Tray
8027 102	Spare Leg, square

Front Pole Bar

Model comes with rotating EVA supports with adjust settings.

Code	Model
8028 135	Front Pole Bar



Feeder Arm

Indispensable on-accessory for platforms or boxes when feeder fishing. Design also allows the rod to be positioned at a high angle for river fishing to keep line clear of flowing water.

Code	Model
8204 001	Feeder Arm



Spare parts

Code	Model
8028 056	Box lock
8028 101	Top Cover Module (41 x 29 x 2 cm)
8028 105	Basic Module (41 x 29 x 4 cm)
8028 106	Flat tackle section (41 x 29 x 4 cm), Trade pack - 3 Pieces
8028 108	Deep storage section (41 x 29 x 6 cm), Trade pack - 2 Pieces
8028 110	Module with two side sections (41 x 29 x 12 cm)
8028 120	Short umbrella holder (30 cm)
8028 121	Pole holder (2 piece)
8028 125	Feeder Arm (95 cm - 165 cm)
8028 126	Straight keepnet holder (25 cm)
8028 128	Long umbrella holder (45 cm)
8028 129	Round accessory adapter (11 cm)

Kit Holder

A top kit holder for platforms and boxes. A neat solution to safely store extra kits while fishing.

Code	Model
8204 002	Kit Holder

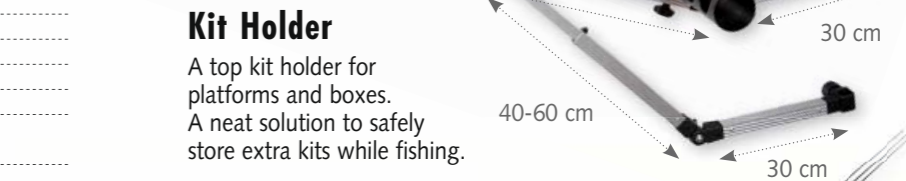

All box accessories fit std. square and 25mm round legs

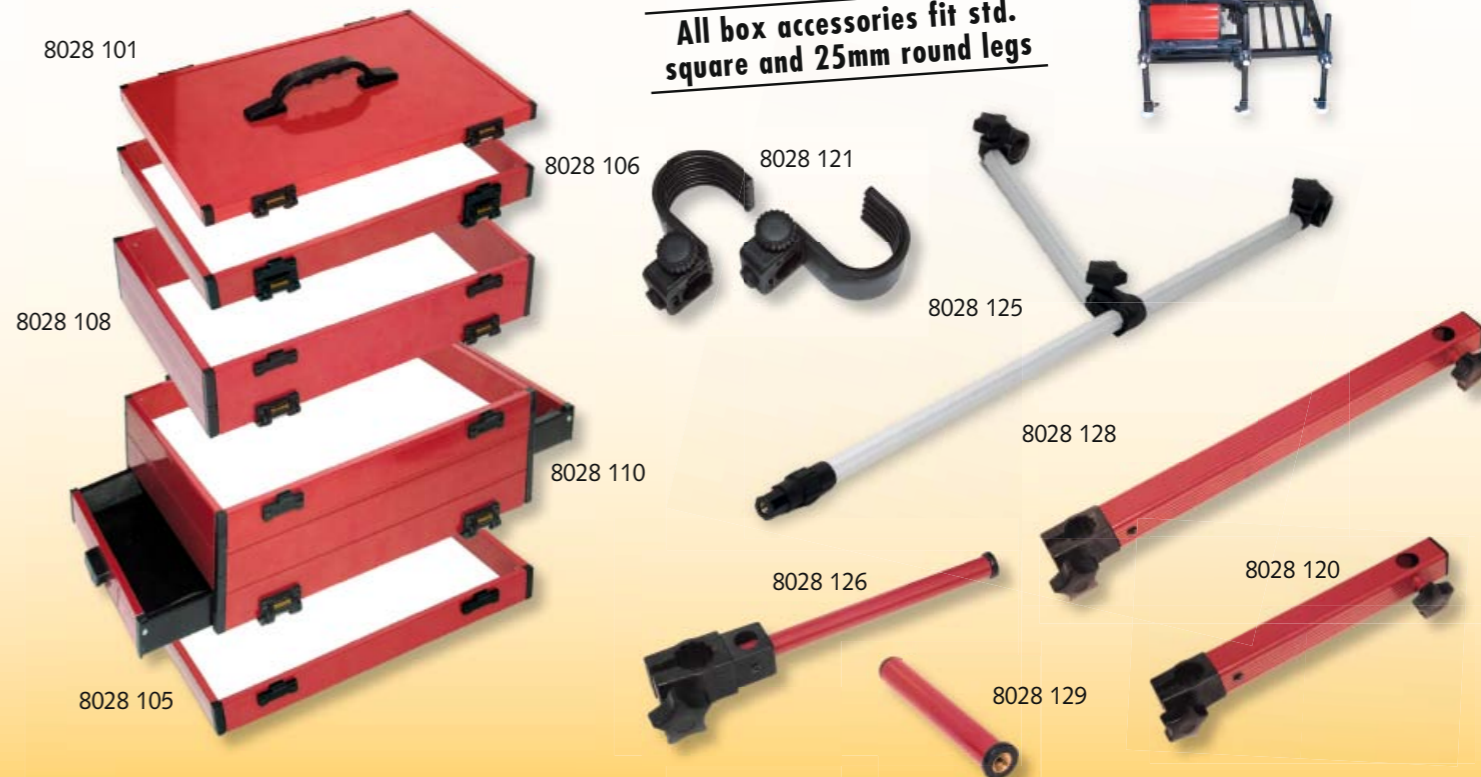

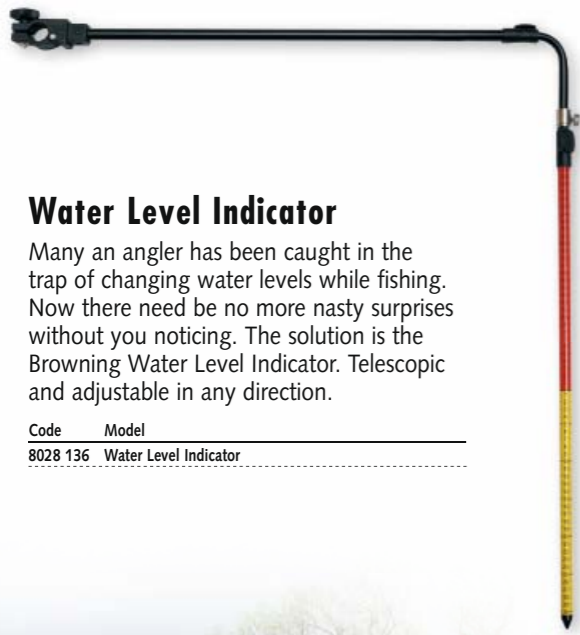

Water Level Indicator

Many an angler has been caught in the trap of changing water levels while fishing. Now there need be no more nasty surprises without you noticing. The solution is the Browning Water Level Indicator. Telescopic and adjustable in any direction.

Code	Model
8028 136	Water Level Indicator



Kit Roost

Code	Model
8028 131	Kit Roost



Folding Bait Box Holder

Practical yet simple and takes up little space. The folding holder allows you to place up to three bait boxes close at hand at the side of your seat box. Also suitable for 8514 009 (see next page).

Code	Model
8028 137	Folding Bait Box Holder

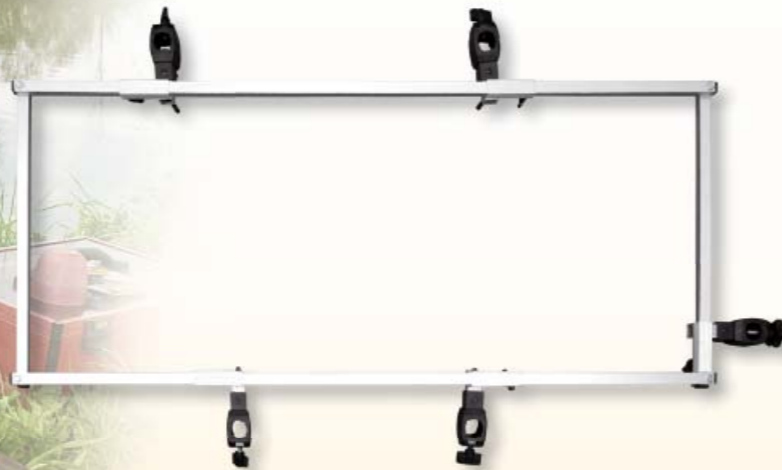

Match Trolley

Bad backs can now be a thing of the past with this practical Browning trolley. Strong enough to handle all of your equipment and so small when collapsed that it will easily fit in your car boot. Also supplied with high quality carrying bag.

Code	Model	Size	Weight
8705 002	Match Trolley	55 x 50 cm	6 kg
Trade pack - 2 Pieces			



Small wheels also give the transport outstanding load capacity.



Bait Box

A fantastic square bait box with air tight closing lid. There is no escape for maggots and mice can not get in. Box comes from the food sector where it must meet the strictest criteria. Remarkably good value for money and worthwhile investing in a whole set.

Code	Model	Size
8514 009	Bait Box	17l
Trade pack - 5 Pieces		

Shelter Side Tray

Ingenious side tray. With connection to square or round legs of a platform (to \varnothing 25 mm) and its own foot for support. However, the bonus feature is the convertible style cover, which protects baits and other items on the side tray from the sun and rain. The cover is adjustable and can be strapped back completely.

Code	Model	Length x Depth
8703 011	Shelter Side Tray	40 cm x 40 cm
8703 010	Shelter Side Tray	65 cm x 46 cm

Fits std. square and 25mm round legs



200 D Nylon



Peter Thomas (GB)



Groundbait Bucket/Cover

Large capacity bucket with handle for mixing volumes of groundbait. Giant 40 liter model with optional cover with zip top opening. The 30l Bowl is supplied with lid and round bait bowl.

Code	Model	
8514 005	Bucket 17 liter	(A)
8514 010	Bucket 30 liter with lid and bowl	(B)
8514 007	Bucket 40 liter	(C)
Trade pack - 5 Pieces (except 8514 007)		

Round Riddle

3 different mesh widths. Fits to 17l bucket 8514 005 or 8514 010.

Code	Model	Mesh Size	for bucket
8706 001	Riddle	6 mm	8514 005
8706 002	Riddle	4 mm	8514 005
8706 003	Riddle	2 mm	8514 005
8706 004	Riddle	6 mm	8514 010
8706 005	Riddle	4 mm	8514 010
8706 006	Riddle	2 mm	8514 010
Trade pack - 5 Pieces			



Box Set

Important measuring cups for all matches in accordance with CIPS rules. Like shown below.

Code	Model
8172 999	Box Set
Trade pack - 5 Pieces	



Bait Boxes

Five different sized bait boxes with lids. As you can never have enough of them, we are pleased to offer them at very competitive prices.

Code	Model	Size
8172 001	Baitbox	0.60 l (A)
8172 002	Baitbox	1.25 l (B)
8172 003	Baitbox	2.50 l (C)
8172 005	Baitbox	1.00 l (D)
8172 006	Baitbox	1.50 l (E)
Trade pack - 10 Pieces		



Dip Holder

Insert for bait boxes for storing bait dips in such a way that they cannot tip over. Fits 8172 002-003.

Code	Model
8173 001	Dip Holder
Trade unit = 10 pieces	



Ø 46 mm



Groundbait Whisk

Optimised design. Reaches into the tightest corners of the mixing bowl. With 8 mm shaft, fitting into common akku drills.

Code	Model	Size
6501 003	Groundbait Whisk	14 cm x 30 cm



4 Blade Worm Scissors

After the success of our worm chopper we have added to our range worm scissors equipped with four cutting blades. The perfect tool for chopping larger quantities of worms for loose feeding.

Code	Model
6531 002	4 Blade Worm Scissors
Trade pack - 5 Pieces	



Bloodworm Foam

Bloodworm and joker for the hook are best prepared by placing on a piece of foam soaked in water in a bait box. When you need to take one out, simply press softly on the foam and a worm pops to the surface.

Code	Model	Size	P/Pack
8172 008	11 x 11 cm	2.5 cm	2
8172 009	15 x 15 cm	2.5 cm	2
Trade unit = 10 pieces			

Worm Chopper

Those who like to cut up large quantities of worms for feeding during fishing have so far had to make do with triple blade scissors. The Browning Worm Chopper is a far more convenient and energy saving solution. Simply lay the worms on a surface or bowl and roll over them as many times as necessary. Easy to clean.

Code	Model
6531 001	Worm Chopper
Trade pack - 5 Pieces	



Kit Roost

Free-standing roost for top kits. When you want to keep your valuable top kits off the ground, this is the practical solution.

Code	Model
8201 025	Kit Roost (C)

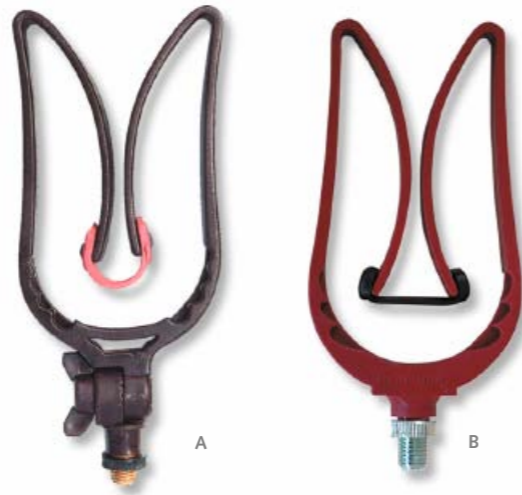

Pole Clips

By using a length of elastic this clip fits various pole diameters. The standard design has an additional joint for adjusting the angle. The Deluxe design has an extra soft clamping elastic – ideal for high quality poles.

Code	Model
8201 005	Pole Clip (A)
Trade pack - 10 Pieces	
8201 007	Pole Clip Deluxe (B)
Trade pack - 5 Pieces	

Double Kit Roost Tripod

Practical tripod for positioning kits or poles at the swim. Assembles effortlessly and very secure. 50-100 cm.

Code	Model
8201 020	Double Kit Roost Tripod (E)

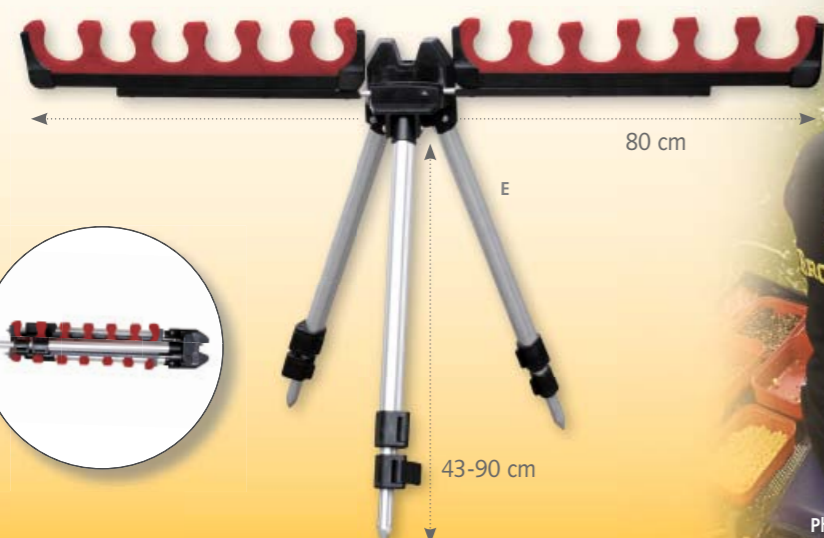

Pole Roosts

Burgundy EVA roost. With 6 supports.

Code	Model
8203 021	Standard Roost (E)
Trade pack - 5 Pieces	



Roosts

Available for 6 or 12 kits, supplied in pairs with the front roost in a thinner diameter than the rear. Size 12 roost with three screw threads for secure fixing in the ground.

Code	Model
8203 010	Kit roost set 6 rods (F)
8203 011	Kit roost set 12 rods (G)
Trade pack - 5 Pieces	



Feeder Rod Rests

Five different rod rests all allowing individual positioning of the feeder rod to suit the requirements of every situation.

Code	Model
8202 018	Deluxe (H)
8202 014	Special Bar (I)
8203 012	Feeder Rest (J)
8203 013	Feeder Rest 35 cm (K)
8203 014	Feeder Rest 62 cm (L)
Trade pack - 5 Pieces	



Photo IYCF / Bauer Media

Windguard Pole Roller Kit

Set consisting of a robust tripod and deep V-Roller with rubber clamp to secure the pole from any movement. Height adjustable and with hooks for anchoring items above the ground. With its screw fastening facility the Windguard-V-Roller is particularly robust and offers compact storage.

Code	Model	Size	Weight
8201 016	Pole Roller	60-125 cm	1.3 kg



Tough Pod

Highly robust tripod. Stands extremely firm in all kinds of weather.

Code	Model	Size	Weight
8201 017	Tough Pod	51-81 cm	1.5 kg



Tripod

On hard, uneven ground a tripod is your best bet for mounting rod rests. Extendable in three places with hook for hanging stabiliser weights. 48cm - 108cm.

Code	Model	Weight
8201 008	Tripod	1.2 kg

Long John Pole Roller

The Rolls-Royce of pole rollers. A true giant that can be extended to two metres in height. The „double V“ roller system keeps sections apart if broken down twice. Perfect for shipping back over high banks or bushes but the legs still fold to a very compact size for transportation.

Code	Model	Size	Weight
8201 024	Long John	50-120 cm	2.9 kg



Tripod legs open flat, providing stability on rough terrain.





Flatbed Roller Head
Extra wide roller support for positioning poles.
Code Model
8201 018 Flatbed Roller Head (C)
Trade unit = 2 pieces

Windguard V Roller

Large V-Roller with a gap in both rollers. The ridge prevents the pole from climbing or blowing upwards when taking it apart. The pole remains in the lower area, considerably reducing breakages.

Code Model
8201 015 Windguard V Roller (D)
Trade pack - 2 Pieces



Flat Bed Pole Roller

A traditional and popular design of flat bed roller. The 2 roller sections provide a wide „target“ area and effectively act as 2 rollers if breaking a pole down twice. Good quality, light in weight but very stable due to the roller width and wide angled telescopic legs. Supplied in carry bag.

Code Model Weight
8201 027 Flat Bed Pole Roller 1.57 kg

„W“ Pole Roller

A new style of flat bed roller combining the best aspects of flat and V rollers. The unique W shape always moves the pole gently over to the side roller when shipping back. This eliminates the section breaking danger of poles being blown across and out of the flat roller in windy condition. The 2 roller sections provide a wide „target“ area and effectively act as 2 rollers if breaking a pole down twice. Has telescopic folding legs and is supplied with carry bag.

Code Model Weight
8201 026 „W“ Pole Roller 1.57 kg

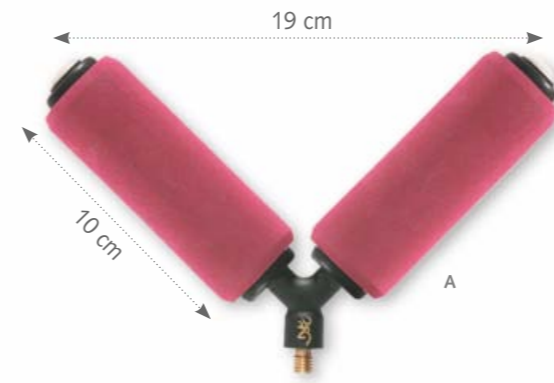

Match Pole Rollers

A comprehensive range of pole rollers featuring attractive burgundy EVA rollers. All feature a sturdy brass fitting and stud.

Code Model
8201 001 Mini (A)
8201 002 Standard (B)
Trade pack - 5 Pieces

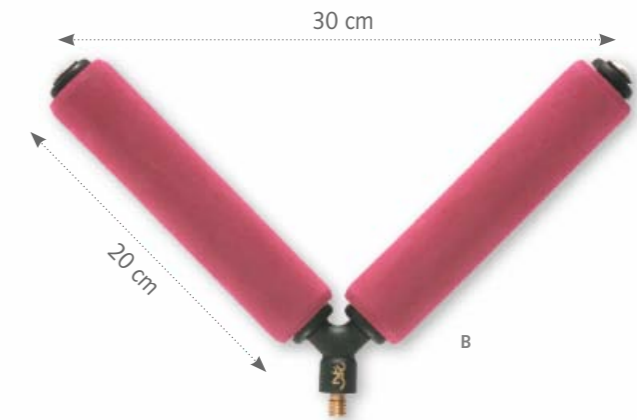

Totally wind proof!



Loop Pole Roller

A unique alternative to large V rollers and the total solution to windy days! Two rotating rollers with an EVA covered top section gives smooth shipping and completely protects the pole. Particularly good when fishing a short pole - or when trying to find the same hole in a bush or fence behind you when shipping back! Compact and easy to carry. Available in two sizes. Pair up with one of our tripods on page B106-107.

Code Model Size
8201 021 Pole Roller S 14 x 26 cm
8201 022 Pole Roller L 32 x 25 cm
Trade pack - 2 Pieces



Pole Catcher

Small net for protecting pole sections. V-shaped leading edge allows a pole to be placed in from above without rolling out.

Code Model
8201 010 Pole Catcher
Trade pack - 5 Pieces



What should the perfect fishing bag look like? Light and budget friendly or a high quality finish even if it means a little more expense? True match anglers do not need long to think about the answer – and our test anglers were unanimous that the range of Browning bags and holdalls should represent the ultimate in quality above all else. That is why we have only used the most robust Oxford nylon qualities with durable components such as buckles and eyes and extra strong zips.



New 2m extra long version for our Z12 and other long section poles.

Xitan Tube Holdall

Smart rod/pole holdalls in four sizes. Each has been made slightly oversized, so zips are not strained if used with large tubes, and feature a single large and deep front pocket with long zip that will carry long and bulky accessories. A side quiver allows an umbrella to be carried outside the main holdall. The holdalls have a rubber reinforced base to resist wear. The 6 tube has a single compartment with full length heavy duty zip. This holdall will actually carry more than 6 tubes and is a good choice for the typical angler. The 12 tube "Mega Holdall" has 2 compartments, both with full zips. It has a huge capacity and is the perfect choice for the angler that likes to carry absolutely everything!

Code	Model	Length	Capacity
8523 001	6 Tube Holdall	1.85 m	6 tubes
8523 002	12 Tube Holdall	1.85 m	12 tubes
8523 026	6 Tube Holdall	2.05 m	6 tubes
8523 027	12 Tube Holdall	2.05 m	12 tubes



Xitan Combo Rod Holdall

The ultimate match holdall: The Combo Rod Holdall holds up to 6 rigged up rods (two per section) and all accessories. The rod sections are upholstered and offer 100% protection for your tackle. The shoulder straps are attached to the holdall in such a way that the holdall moulds to the back perfectly when carrying

Code	Model	Length	Capacity
8523 003	Combo Rod Holdall	1.65 m	3 compartments



Xitan Commercial Ready Rod Bag

Designed to allow two rigged up rods to be protected and carried to the water's edge. A two-way zip that runs the full length of the rod bag enables the rods to be taken out extremely quickly. The base has been reinforced and the reel sections given extra upholstery for optimal protection during transport. Additional features include an upholstered carry strap and extra carry handles.

Code	Model	Length	Capacity
8523 019	Ready Rod Bag	1.45 m	1 compartment
8523 025	Ready Rod Bag	1.60 m	1 compartment
8523 004	Ready Rod Bag	1.80 m	1 compartment



Xitan Rod Safe

Very rigid, hardcase rod carriers that will completely protect made-up rods. The oversized reel pouches will accommodate large reels, but also allow multiple rods to be stored "in-line" – a much more compact solution than wide traditional multi-rod carriers. The carriers have full-length zips for easy access. The small size takes up to 2 rods, the large size up to 3 rods.

Code	Model	Length	Capacity
8523 023	Xitan Rod Safe	1.80 m	2 Rods
8523 005	Xitan Rod Safe	1.80 m	3 Rods



Xitan Stiffy Single Rod Bag

A new design of a light hardcase carrier for made-up rods. Instead of full length zips, which can damage or cut the line, these rodcases feature a zip-flap arrangement. The rods are simply slid into a protection tube, then a flap with a built in reel pouch is closed over the reel and zipped up. 100% protection for rod, reel and line. Complete with carry strap.

Code	Model	Length	Capacity
8523 028	Xitan Stiffy Single Rod Bag	1.55 m	1 Rod
8523 029	Xitan Stiffy Single Rod Bag	1.75 m	1 Rod

Xitan Basic Rod Holdall

Perfect for anglers who want to be organised at the water but prefer to limit themselves to the essential equipment. Offers room for up to 5 rod tubes which can be easily removed over three quarters of the holdall's length due to the two way zip. With reinforced floor in hard plastic. One short and one long side pocket for accessories including landing net handles, rod rests and umbrellas. Comes with an upholstered shoulder strap.

Code	Model	Length	Capacity
8523 006	Basic Rod Holdall	1.80 m	4 tubes



1200 D Oxford NYLON
All luggage of this page

Xitan Carryall

Highly versatile bag for carrying various accessories such as pole rollers, rod rests, bait box holders etc. The main section is finished with a reinforced seam to retain its shape. With carry strap and side accessory pocket.

Code	Model	Length
8523 021	Carryall	1.00 m
8523 007	Carryall	1.25 m
8523 020	Carryall	1.50 m



Xitan Carryall L & XL

The Xitan Carryalls have been developed for modern match fishing, where large quantities of equipment are generally carried to the water. The robust material and high quality buckles and fasteners ensure that the bags do not let you down even when filled to the brim. Finished with elegant features such as side handles for easier loading and unloading from the car.

XL Model: No match carryall offers more space. With hard base to ensure the carryall always retains its shape. Two side pockets and a large keepnet bag (e.g. for more than one keepnet) to the front. Available separately: Cooler section, inserts into the Carryall perfectly.

L Model: Approximately one third smaller, the ultimate carryall for match anglers – neither too small nor too large, for carrying all essential equipment to the water's edge. Also with hard base, two side pockets and a keepnet section.

Code	Model	Size
8523 008	Carryall XL	60 cm x 45 cm x 58 cm
8523 009	Carryall XL inner cooler bag	20 cm x 38 cm x 48 cm
8523 010	Carryall L	43 cm x 36 cm x 58 cm



Xitan Commercial Carryall

A different design of carryall which has 2 separate full length zipped compartments, this allows tackle, bait etc. to be better organised than conventional single compartment carryalls. Store bait one side and rollers etc. the other, or keep clothing and food separate from bait and tackle. Convenient and smart.

Code	Model	Size
8523 024	Xitan Commercial Carryall	55 cm x 35 cm x 38 cm



Coolbag fits inside Carryalls



Inner Cooler Bag



All luggage of this page



Xitan Standard Carryall

Average-sized model with deep front section for storing side trays or several keepnets etc. and two side pockets. Also with carry handles and an adjustable carry strap.

Code	Model	Size
8523 011	Standard Carryall	45 cm x 25 cm x 55 cm

Xitan Carryall S

Highly compact carryall for feeder anglers. With the same outstanding features as its bigger brother in the Xitan range but with overall smaller dimensions.

Code	Model	Size
8523 022	Xitan Carryall S	33 cm x 30 cm x 50 cm



Xitan Cooler Bag

Indispensable bag for carrying fresh bait to the water, in any kind of weather. Also useful for storing the angler's food of course... Covered with foil for insulation. Takes up to 6 x 1-l bait boxes. Separate top section for separate storage of bloodworm and joker.

Code	Model	Size
8523 012	Cooler Bag	30 cm x 38 cm x 26 cm





Protective Rod Sleeve

A very effective and low cost alternative for protecting made-up rods in transit. Each pack contains 2 long padded sleeves that are secured with neoprene straps and velcro. No other straps needed! 2 pieces per pack.

Code	Model
8518 025	Protective Rod Sleeve
Trade pack - 5 Packs	



Pan Groundbait Holder

Practical side holder for keeping additional groundbait types within easy reach of the seatbox. The side pocket has a cover to protect the groundbait from sun or rain.

Code	Model	Ø
8523 017	Pan Groundbait Holder	30 cm



Waterproof Keepnet Bag

A totally waterproof way of transporting wet nets. Our bags are made from top quality nylon that resists premature wear and cracking – not to be confused with cheaper products on the market.

Code	Model	Length	Depth	Width
8401 001	Keepnet Bag	55 cm	55 cm	12 cm
8401 002	Keepnet Bag	55 cm	55 cm	25 cm



1200 D Oxford NYLON

Groundbait Bowls

Small, practical bowls for holding bait and groundbait. Item numbers 8523 015 and 016 have a zip-fastening cover to protect groundbait from drying out. Packs away to a small size.

Code	Model	Ø
8523 014	Groundbait Bowl	20 cm
8523 015	Groundbait Bowl	30 cm
8523 016	Groundbait Bowl	40 cm



Multi-Purpose Bag

For storing reels, spare spools, forceps, feeders, catapults etc... The applications are endless for this handy transport accessory. With allround zip fastener.

Code	Model	Size
8523 013	Multi-Purpose Bag	19 x 10 cm



Rod Velcro Fastener

Stretchy neoprene straps with a long velcro section. A set of two straps in each pack.

Code	Model
8523 018	Rod Velcro Fastener
Trade unit = 10 pieces	



Top quality, impact resistant even at low temperatures

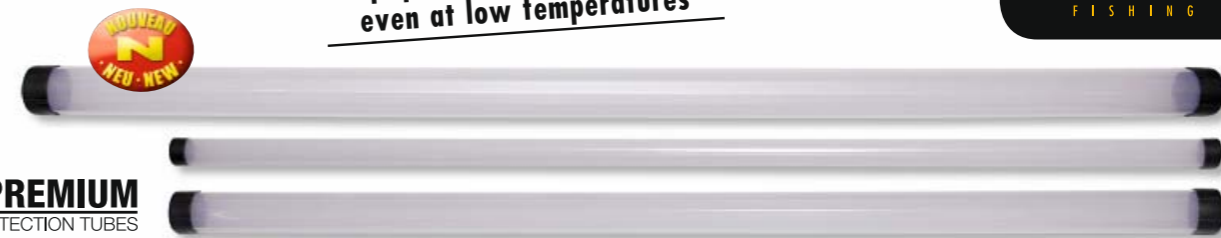

Premium quality protective tubes

These top-quality tubes resist both cracking in low temperatures and distortion in high temperatures. Your valuable poles and rods deserve the best protection available.

Code	Model	Length	Ø
8510 010	Transport Tube	2.05 m	6 cm
8510 011	Transport Tube	1.60 m	4 cm
8510 012	Transport Tube	1.60 m	6 cm
Trade unit = 5 pieces			

Bait Umbrella

Small 4 spike umbrella to protect the side tray from rain or sun.

Code	Model	Ø	Tr.-Length
9972 110	Bait Umbrella	1.45 m	1.00 m



Heavy Duty Quality



Browning Umbrella

Sometimes the heavens open. But with Browning umbrellas, you can stay dry in the fiercest downpours. The large, burgundy umbrella in conventional design has undergone a further PVC coating and reinforcement since previous years.

Code	Model	Ø	Tr.-Length
9972 250	Umbrella	2.50 m	1.35 m

Carpa Keepnet

Strong, "no nonsense", 3m keepnet for big catches. Made in a traditional, tear-proof, carsack material. Covered wire bottom rings and large angle-tilt top ring.

Code	Model	Size
7047 300	Carpa Keepnet	40 cm x 50 cm



All Keep Nets



Force Keepnet

An excellent value-for-money keepnet range suitable for all types of angler. Features a quick-drying mesh material that also resists "fishy odours" so definitely "car friendly". The strong rings have protection to prevent premature wear. Good looking, good value and practical nets.

Code	Model	Size
7048 350	Force Keepnet	350 cm x 60 cm
7048 400	Force Keepnet	400 cm x 60 cm
7048 450	Force Keepnet	450 cm x 60 cm



Starter Keepnet

Value for money circular keepnet in extremely quick drying material. Ideal for beginners. Length up to 4m.

Code	Model	Size
7005 200	Starter Keepnet	200 x ø 50 cm
7005 250	Starter Keepnet	250 x ø 50 cm
7005 300	Starter Keepnet	300 x ø 50 cm
7005 350	Starter Keepnet	350 x ø 50 cm
7005 400	Starter Keepnet	400 x ø 50 cm
7005 450	Starter Keepnet	450 x ø 50 cm
7005 500	Starter Keepnet	500 x ø 50 cm



Keepnet Weight

Screws externally to a keepnet ring. Surely the simplest method to weight a keepnet without endangering the fish in the net.

Code	Model	Weight
6069 200	Keepnet Weight	200 g

Trade unit = 5 pieces



Open Mesh Keepnet

A keepnet design with particularly large mesh, which is still extremely kind to fish and enables water to pass optimally through the net. Ideal for use in flowing water and in the height of summer when the oxygen levels would fall too low without this exchange of water. With metal screw joint and externally coated rings to protect against wear.

Code	Model	Size
7007 350	Open mesh Keepnet	350 x ø 50 cm
7007 400	Open mesh Keepnet	400 x ø 50 cm
7007 450	Open mesh Keepnet	450 x ø 50 cm



Rubber Mesh Keepnet

By popular demand, keepnets with rubber-coated net material. Optimum protection for fish combined with almost instant drying. Also extremely wear resistant and long lasting.

Code	Model	Size
7041 350	Rubber Mesh Keepnet	350 x ø 50 cm
7041 400	Rubber Mesh Keepnet	400 x ø 50 cm

CSpec Keepnet

The strongest keepnets available! Designed for big catches. The bottom 3 rings are metal and completely enclosed in thick plastic tube to totally eliminate wear and prevent ring breakage. They feature external handles so that big catches can be lifted without stressing the rings. The top ring is metal and has a strong angle tilt mechanism. The smooth mesh is kind to fish and resists tearing. Available in 3 lengths.

Code	Model	Size
7045 250	CSpec Keepnet	50 x 45 x 250 cm
7045 300	CSpec Keepnet	50 x 45 x 300 cm
7045 350	CSpec Keepnet	50 x 50 x 350 cm



All Keep Nets

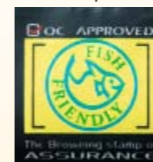

The strongest keepnets available

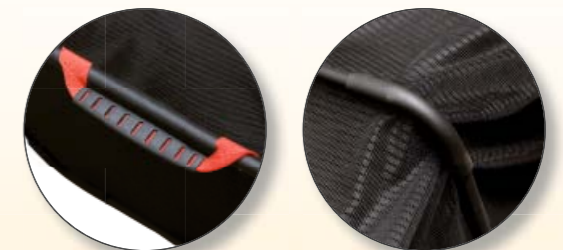

MSpec Keepnet

A smaller version of our CSpec keepnet with all the same features. Very compact and ideal for Silverfish.

Code	Model	Size
7044 270	MSpec Keepnet	40 x 36 x 270 cm



Using our extensive experience in rod building we now offer a comprehensive series of high quality landing net handles. The result: A series of superbly strong yet light-weight handles in a choice of telescopic or put over designs in glass fibre or carbon.

All Net Handles have 100% secure, brass, glued and riveted threads.



Xitan Even Longer (A) (take-apart)

Code	Model	Length	Sections	Tr.-Length	Material	Weight
7100 360	Xitan Even Longer	3.60 m	3	1.45 m	Carbon	347 g
7100 500	Xitan Even Longer	5.00 m	4	1.46 m	Carbon	568 g

Black Magic Slimstar Power (B) (take-apart)

Code	Model	Length	Sections	Tr.-Length	Material	Weight
7102 280	Slimstar Power	2.80 m	3	1.56 m	Carbon	191 g
7102 400	Slimstar Power	4.00 m	2	1.45 m	Carbon	310 g

Force Stiffy (C) (take-apart)

Code	Model	Length	Sections	Tr.-Length	Material	Weight
7101 300	Force Stiffy	3.00 m	3	1.08 m	Carbon	381 g

Ambition Tele (D + E) (tele)

Code	Model	Length	Sections	Tr.-Length	Material	Weight
7103 220	Ambition Tele Match (D)	2.20 m	2	1.25 m	Glass	315 g
7103 250	Ambition Tele Carp (E)	2.50 m	2	1.35 m	Glass	400 g



Ambition Power Net Handle (F) (take-apart)

Code	Model	Length	Sections	Tr.-Length	Material	Weight
7175 340	Power Net Handle 340	3.40 m	3	1.35 m	Composite	368 g
7175 420	Power Net Handle 420	4.20 m	4	1.15 m	Composite	590 g

Ambition Tele Net Handle (G) (tele)

Code	Model	Length	Sections	Tr.-Length	Material	Weight
7176 270	Tele Net Handle 270	2.70 m	3	1.00 m	Composite	410 g
7176 330	Tele Net Handle 330	3.30 m	3	1.15 m	Composite	435 g

Ambition X-Cite (H) (tele)

Code	Model	Length	Sections	Tr.-Length	Material	Weight
7173 225	X-Cite Tele Match Handle	2.25 m	2	1.25 m	Glass	315 g
7174 250	X-Cite Tele Carp Handle	2.50 m	2	1.35 m	Glass	400 g

Match anglers will buy numerous landing nets during their angling career. Our nets have been designed by world champions whose aim is to offer you the best nets possible to suit your price range. Super light weight construction. Locking screw reinforced with plastic ABS insert. Available in pan spoon or round, in choice of sizes for various applications.



Pan Spoon

Code	Model	Size
7029 001	Pan Spoon	45 x 55 cm



Magic Monyl

Code	Model	Size
7029 008	Magic Monyl L	45 x 55 cm
7029 022	Magic Monyl M	45 x 40 cm



Magic Monyl, black

Code	Model	Size
7029 037	Magic Monyl L	45 x 55 cm



Magic Monyl River Scooper

Code	Model	Size
7029 010	Magic Monyl River Scooper L	55 x 45 cm
7029 011	Magic Monyl River Scooper M	45 x 40 cm



Magic Scooper

Code	Model	Size
7029 009	Magic Scooper	35 x 31 cm

Non-Snag Hair Rigger Landing Nets

Light weight but strong net heads with finer meshes to minimise snagging and hair-rig damage. Available in fine and ultra-fine meshes to suit angler's preferences and needs. Good looking, very kind to fish and also make a perfect large silverfish net. Full metal blocks, brass threads and D profile frames for strength.

Code	Model	Size
7029 029	Non Snag (A)	55 cm x 45 cm x 25 cm
7029 035	Non Snag Ultrafine (B)	55 cm x 45 cm x 25 cm

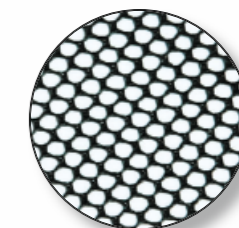

Latex Quick Dry Landing Nets

Latex covered mesh net heads in 4 sizes. The ultra strong, long-life mesh retains its shape in the water and makes "scooping" fish easier. They also "Shake-dry" in seconds.

Code	Model	Size
7029 030	Latex Quick Dry S (A)	45 cm x 35 cm x 25 cm
7029 031	Latex Quick Dry M (B)	50 cm x 38 cm x 28 cm
7029 032	Latex Quick Dry L (C)	60 cm x 48 cm x 30 cm
7029 036	Latex Quick Dry XL (D)	60 cm x 48 cm x 50 cm

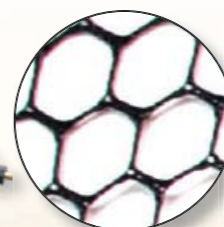
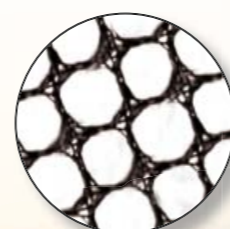
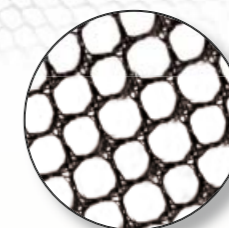



Carp-Mega Net Head

Code	Model	Size
7029 017	Carp-Mega Net Head	65 x 70 x 75 cm



Foldable Net Head

Code	Model	Size
7029 016	Foldable Net Head	45 x 55 cm



Power Carp

Code	Model	Size
7029 018	Power Carp Medium	55 x 45 x 26 cm

Buoyancy Aid

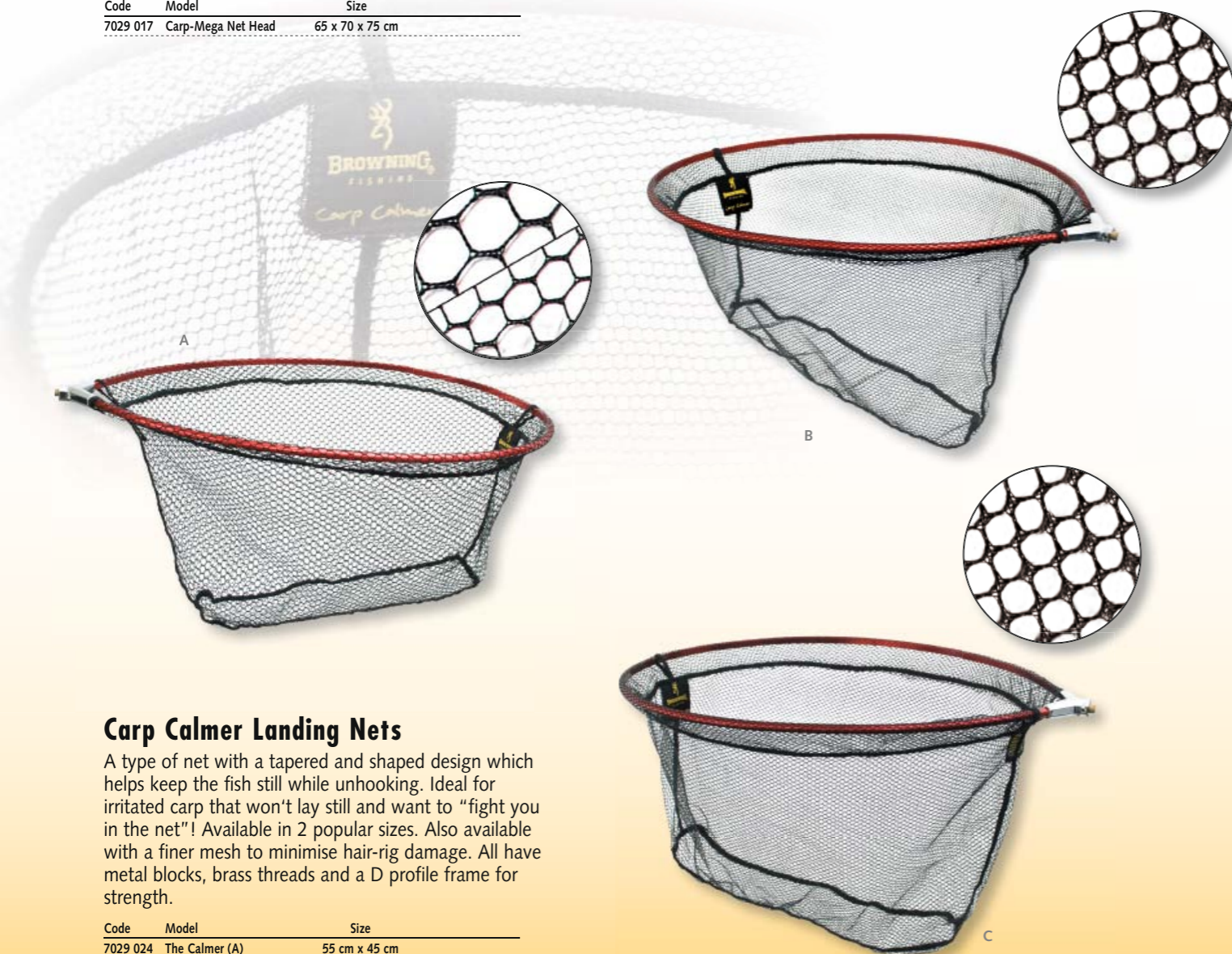

Carp Calmer Landing Nets

A type of net with a tapered and shaped design which helps keep the fish still while unhooking. Ideal for irritated carp that won't lay still and want to "fight you in the net"! Available in 2 popular sizes. Also available with a finer mesh to minimise hair-rig damage. All have metal blocks, brass threads and a D profile frame for strength.

Code	Model	Size
7029 024	The Calmer (A)	55 cm x 45 cm
7029 033	Carp Calmer Hair (B)	55 cm x 45 cm x 30 cm
7029 034	Silver Calmer (C)	50 cm x 38 cm x 30 cm



Power Gold Landing Nets

These perfectly sized, strong, light and good-looking net heads all have metal blocks, brass threads and a D profile frame for total reliability. Available in 2 "Power Carp Gold" sizes, and in a smaller "Power Silverfish Gold" size with a finer mesh.

Code	Model	Size
7029 027	Power Carp Gold L (D)	55 cm x 45 cm x 28 cm
7029 028	Power Carp Gold XL (E)	60 cm x 50 cm x 25 cm

Silverfish Gold Net

Code	Model	Size
7029 025	Silverfish Gold Net (F)	50 cm x 40 cm x 25 cm

GORE-TEX® Halkon Hunt Browning 3/4 Jacket

Classic tried and trusted jacket for match anglers wanting the very best in weather protection. Wind and waterproof yet fully breathable thanks to its patented Gore-Tex® two-layer laminate.

Code	Model	Size
8970 001	3/4 Jacket	M
8970 002	3/4 Jacket	L
8970 003	3/4 Jacket	XL
8970 004	3/4 Jacket	XXL
8970 005	3/4 Jacket	XXXL

Shell Fabric: 100% Nylon Fabric
Functional Layer: 100% GORE-TEX® Membrane



GORE-TEX® Halkon Hunt Browning Bib & Brace

Traditional Bib and brace in Gore-Tex® three-layer laminate to complement our 3/4 jacket. Total protection for anglers that demand the best.

Code	Model	Size
8970 001	Hunt 3/4 Jacket	M
8970 002	Hunt 3/4 Jacket	L
8970 003	Hunt 3/4 Jacket	XL
8970 004	Hunt 3/4 Jacket	XXL
8970 005	Hunt 3/4 Jacket	XXXL

Shell Fabric: 100% Nylon Fabric
Functional Layer: 100% GORE-TEX® Membrane



Water-X-Jacket

Water-X is the magic material! It prevents wind and water from reaching the angler's skin but allows body moisture to escape reliably. Consequently, the angler is always warm and comfortable in this modern tailored jacket. No storm will be too fierce.

Code	Model	Size
8965 001	Water-X-Jacket	M
8965 002	Water-X-Jacket	L
8965 003	Water-X-Jacket	XL
8965 004	Water-X-Jacket	XXL
8965 005	Water-X-Jacket	XXXL

100% Nylon



Water-X-Bib and Brace

The ideal complement to the Water-X-Jacket. Lined and reinforced at knees and seat to prevent wear. High cut design to keep the back area warm.

Code	Model	Size
8966 001	Water-X-Bib and Brace	M
8966 002	Water-X-Bib and Brace	L
8966 003	Water-X-Bib and Brace	XL
8966 004	Water-X-Bib and Brace	XXL
8966 005	Water-X-Bib and Brace	XXXL

100% Nylon



Wind-X fleece can be zipped into the Water-X coat.



Wind-X-Fleece

Perfect for weather in between seasons. When it is no longer warm enough to sit at the water in a T-Shirt but not yet cold enough to put on the thermal overalls, the Wind-X-Fleece is the perfect choice.

Code	Model	Size
8949 001	Wind-X-Fleece	M
8949 002	Wind-X-Fleece	L
8949 003	Wind-X-Fleece	XL
8949 004	Wind-X-Fleece	XXL
8949 005	Wind-X-Fleece	XXXL

100% Polyester

Overtrousers

Ideal protection against dirt from bait and fish slime. Water resistant and elasticated, with trouser pockets.

Code	Model	Size
8968 001	Overtrousers	M
8968 002	Overtrousers	L
8968 003	Overtrousers	XL
8968 004	Overtrousers	XXL
8968 005	Overtrousers	XXXL
100% Nylon, PU coated, breathable		



Tracksuit Bottoms

Light overtrousers for angling in the warm season. Comfortable material with two pockets.

Code	Model	Size
8933 002	Tracksuit Bottom	M
8933 003	Tracksuit Bottom	L
8933 004	Tracksuit Bottom	XL
8933 005	Tracksuit Bottom	XXL
8933 006	Tracksuit Bottom	XXXL
100% Nylon		

Hooded Sweatshirt

Now you can look practical and fashionable, with the Browning Sweat Shirt in a comfortable hooded design. Ideal for when the weather requires additional warmth.

Code	Model	Size
8927 002	Hooded Sweatshirt	M
8927 003	Hooded Sweatshirt	L
8927 004	Hooded Sweatshirt	XL
8927 005	Hooded Sweatshirt	XXL
8927 006	Hooded Sweatshirt	XXXL
60% Cotton, 40% Polyester		



Sweat Jacket

Fashionable hooded jacket in insulating fleece material.

Code	Model	Size
8931 002	Sweat Jacket	M
8931 003	Sweat Jacket	L
8931 004	Sweat Jacket	XL
8931 005	Sweat Jacket	XXL
8931 006	Sweat Jacket	XXXL
60% Cotton, 40% Polyester		



Apron

Protects your clothing from dirt, popular with those anglers who prefer to have minimum mess.

Code	Model
9789 000	Browning Apron
80% Cotton, 20% Polyester	



Adam Richards (GB)



Polo Shirt

The Browning polo shirt is now available in the quick-dry material familiar from sports clothing. Particularly useful in the warm season when the angler is exposed to the sun for hours on end.

Code	Model	Size
8932 002	Polo Shirt	M
8932 003	Polo- Shirt	L
8932 004	Polo Shirt	XL
8932 005	Polo Shirt	XXL
8932 006	Polo Shirt	XXXL
100% Nylon (Dri Fit fabric)		



Black and White T-Shirt

Eye-catching t-shirts in high-quality cotton.

Code	Model	Size
8922 000	T-Shirt black	XS
8922 001	T-Shirt black	S
8922 002	T-Shirt black	M
8922 003	T-Shirt black	L
8922 004	T-Shirt black	XL
8922 005	T-Shirt black	XXL
8922 006	T-Shirt black	XXXL
100% Cotton		

Code	Model	Size
8922 100	T-Shirt white	XS
8922 101	T-Shirt white	S
8922 102	T-Shirt white	M
8922 103	T-Shirt white	L
8922 104	T-Shirt white	XL
8922 105	T-Shirt white	XXL
8922 106	T-Shirt white	XXXL
100% Cotton		



Sunglasses

Fulfil two functions: firstly they protect the angler's eyes against harmful UV rays and secondly they improve visibility of a float or feeder tip etc. High quality with polarized lenses. Supplied with hard case and cleaning cloth.

Code	Model	Colour
8910 001	Contact (A)	grey
8910 002	Blue Star (B)	blue
8910 003	Red Heat (C)	red
8910 004	Sandstorm (D)	amber
8910 005	Hot Brownie (E)	brown
8910 006	Sundown (F)	yellow
8910 007	Wide Eye (G)	grey
Trade pack - 3 Pieces		



Sales display for sunglasses

For up to 7 pairs of glasses each.

Code	Model
8910 999	Sales display for sunglasses

Sunglasses assortment. Sales display with 7x 3 of each kind.

Code	Model
8910 998	Sunglasses assortment

Spectacles Safety Strap

Ever dropped your glasses in the water? With this safety strap, it should never happen again. The main advantage of the Browning safety straps is that they are available in a choice of steel wire or nylon, neither of which absorbs sweat. In addition, the bands can be freely rotated in the soft silicon mountings so that they can always be optimally positioned behind the angler's head.

Code	Model	Size
8910 020	Steel Wire	35 cm
8910 021	Nylon	35 cm
8910 120	Steel Wire	45 cm
8910 121	Nylon	45 cm
Trade pack - 5 Pieces		

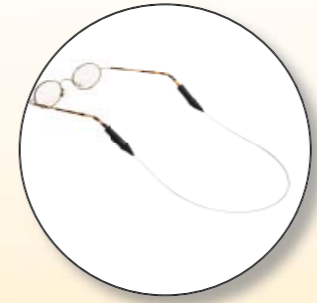

long peak

Caps

Code	Model
9788 040	Sun Shade Cap (A)
9788 041	Universal Cap (B)
9788 042	Tartan Cap (C)
9788 043	Base Ball Cap (D)
9788 021	Cap (E)
Trade pack - 5 Pieces	
100% Cotton	



Fleece Cap

When you have a cold wind, you need something to keep your head comfortably warm. This is a key clothing item for those winter matches.

Code	Model
9788 027	Fleece Cap
100% Polar Fleece	
Trade pack - 5 Pieces	

PROMOTIONAL ITEMS

Promotional Articles

Code	Model
9949 042	Browning Sticker 15 x 12 cm (A)
9949 043	Browning Sticker 24 x 15 cm (B)
9949 044	Browning Sticker 15 x 7.5 cm (C)
9949 035	Hybrid Sticker 10.5 x 7.5 cm (D)
9971 956	Browning Sticker 50 x 20 cm (E)
9971 957	Hybrid Sticker 50 x 20 cm (F)
9949 003	Browning Key Strap
Trade pack - 10 Pieces	



A



B



C



D



E



F



G



Browning Banner

Code	Size
9963 503	Banner 200 cm x 80 cm
100% Nylon	



Peter Thomas (GB)



Hand Towel

Code	Size
9789 003	Hand Towel
Trade pack - 6 Pieces	
100% Cotton	